

2022-2023 PRODUCT CATALOG



TECHNIWELDUSA

TWUSA.COM



No matter your welding needs, **Techniweld USA** is here to help. Founded in 1985, **Techniweld USA** is a comprehensive wholesaler and manufacturer of welding, safety, and industrial supplies. Through joint ventures of American engineering and specialized, yet affordable, overseas manufacturing, we're able to offer the highest quality MIG, TIG, Stick, Oxy-fuel, and safety products at a fraction of the cost of comparable brands.

Techniweld USA is fully committed to customer service. Our five distribution centers across the United States along with our multilingual international export department, allow us to conveniently serve you anywhere in the world. With the most knowledgeable sales, metallurgist, and engineering staff in the industry, **Techniweld USA** is the wholesaler of choice for troubleshooting any welding related hurdles.

Buy with confidence knowing **Techniweld USA's** average employee has over 15 years of welding related experience. We're fully willing and able to serve your welding, safety, and industrial supply needs with the utmost professionalism, experience, and dependability.

Our Commitment

- **Innovative, high quality products at competitive prices**
- **Ample inventory at all of our five locations**
- **Knowledgeable Techniweld USA support available for all products**
- **Full commitment to our customers**

Top Vendor Lines



TABLE OF CONTENTS

STARTING ON PAGE



TECHNIWELDUSA

ARC STAR

FOR ALL YOUR ELECTRIC WELDING ACCESSORIES AND SMAW (STICK) WELDING NEEDS



5



TECHNIWELDUSA

ARMOUR GUARD

FOR ALL YOUR FIRE RESISTANT CLOTHING, HELMETS, AND SAFETY RELATED PRODUCTS



16



TECHNIWELDUSA

BLUE STAR

FOR ALL YOUR OXY-FUEL WELDING, CUTTING, AND GAS FLOW CONTROL



39



TECHNIWELDUSA

CHEM STAR

FOR ALL YOUR CHEMICAL RELATED PRODUCTS



68



TECHNIWELDUSA

FILLER METALS

FOR ALL YOUR MILD STEEL, ALUMINUM, STAINLESS, STEEL, NICKEL, AND ALL OTHER ALLOYS



72



TECHNIWELDUSA

GRIP STAR

FOR ALL YOUR HAND, CLAMPING, AND PIPING TOOL NEEDS



96



TECHNIWELDUSA

MIG STAR

FOR ALL YOUR MIG GUNS, PARTS AND ACCESSORIES



99



TECHNIWELDUSA

SAND STAR

FOR ALL YOUR WELDING ABRASIVE NEEDS



107



DESIGNED TO PROTECT, MANUFACTURED TO LAST



112



TECHNIWELDUSA

TIG STAR

FOR ALL YOUR TIG TORCHES, PARTS, AND ACCESSORIES



130



ARC STAR

**FOR ALL YOUR ELECTRIC WELDING ACCESSORIES
AND SMAW (STICK) WELDING NEEDS**

Electrode Holders	6 - 7
Ground Clamps	7
Welding Cable	8 - 9
Cable Reels	9-10
Cable Connectors	11
Cable Lugs	11
Gouging Torch & Carbons	12-13
Canisters	13
Rap-Arounds	14
Electrode Ovens	14-15

ARC Star™ Electrode Holders

ARC Star's™ electrode holders are made from high quality materials for both high conductivity and improved cable connections. The lever is ergonomically designed for good hand clearance and better hold. The grooved jaw design and high-strength spring ensures a firm grip. We offer a wide range of styles, sizes, and capacities that are lightweight and easy-to-use.



EHB400



EHB600

Bernard® Style Electrode Holders

Features:

- Bernard® Compatible
- Lightweight and easy to operate with good hand clearance and better hold
- The high-temperature and high impact-resistant molded body protects against electrical shock

Item Number	Style	Amp
EHB400	BERNARD® STYLE HORT-STUB ELECTRODE HOLDER	400 AMP

Item Number	Style	Amp
EHB600	BERNARD® STYLE ELECTRODE HOLDER	600 AMP



EHJ300



EHJ500

Jackson® Style Electrode Holders

Features:

- Jackson® Compatible
- Fully insulated and protected springs
- Lightweight and easy to operate with newly designed lever for good hand clearance and better hold
- The high-temperature and high impact-resistant molded body protects against electrical shock
- Grooved jaws allow electrodes to be used at different angles for greater comfort and efficiency

Item Number	Style	Amp
EHJ300	JACKSON® STYLE ELECTRODE HOLDER	400 AMP

Item Number	Style	Amp
EHJ500	JACKSON® STYLE ELECTRODE HOLDER	500 AMP



EHRAF200



EHRAF300



EHRAF500

Lenco® Style Electrode Holders

Features:

- Lenco® Compatible
- Fully insulated and protected springs
- Lightweight and easy to operate with newly designed lever for good hand clearance and better hold
- The high-temperature and high impact-resistant molded body protects against electrical shock

Item Number	Style	Amp
EHRAF200	LENCO® STYLE ELECTRODE HOLDER	200 AMP
EHRAF250	LENCO® STYLE ELECTRODE HOLDER	250 AMP
EHRAF300	LENCO® STYLE ELECTRODE HOLDER	300 AMP

Item Number	Style	Amp
EHRAF350	LENCO® STYLE ELECTRODE HOLDER	350 AMP
EHRAF500	LENCO® STYLE ELECTRODE HOLDER	500 AMP

(Continued on next page)



EHT200



EHT300



EHT500

Tweco® Style Electrode Holders

Features:

- Tweco® Compatible
- Fully insulated and protected springs
- Lightweight and easy to operate with newly designed lever for good hand clearance and better hold
- The high-temperature and high impact-resistant molded body protects against electrical shock

Item Number	Style	Amp
EHT200	TWECO® STYLE ELECTRODE HOLDER	200 AMP
EHT250	TWECO® STYLE ELECTRODE HOLDER	250 AMP
EHT300	TWECO® STYLE ELECTRODE HOLDER	300 AMP

Item Number	Style	Amp
EHT350	TWECO® STYLE ELECTRODE HOLDER	350 AMP
EHT500	TWECO® STYLE ELECTRODE HOLDER	500 AMP
EHT600	TWECO® STYLE ELECTRODE HOLDER	600 AMP

Accessories

Item Number	Style
IT200	INSULATOR FOR EHT200/EHT250 ELECTRODE HOLDER
IT300	INSULATOR FOR EHT300 ELECTRODE HOLDER
IT350	INSULATOR FOR EHT350 ELECTRODE HOLDER

Item Number	Style
INSRAF200	INSULATOR FOR EHRAF200 AND EHRAF250 HOLDER
INSRAF300	INSULATOR FOR THE EHRAF300 AND EHRAF350

ARC Star™ Ground Clamps

ARC Star's™ ground clamp design helps eliminate arc blow and makes it easy to change ground location for the best results. The large contact area assures positive grounding. They are manufactured from copper alloy with forged brass conductors that assure excellent current carrying ability. All steel ground clamps have a copper braided shunt. Tweco® style ground clamps are made with heavy-duty springs to provide positive strength at jaws.

Features:

- Heavy duty insulated spring
- Rugged and reliable copper cast design
- Can be used in stick welding, submerged arc welding, gas metal arc welding and gas tungsten arc welding applications

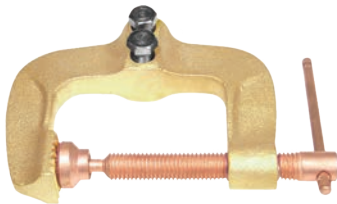

GC80

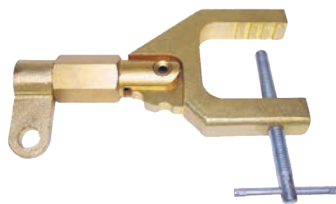

GCECR800L

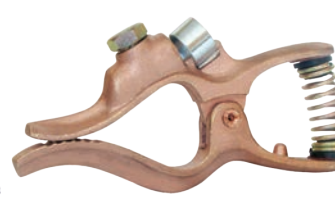

GCT200



GCWAK500

Item Number	Style	Amp
GC80	GROUND C-CLAMP	800 AMP
GCECR800L	ST-107 ROTARY GROUND CLAMP	800 AMP
GCJ300	JACKSON® STYLE GROUND CLAMP	300 AMP
GCJ500	JACKSON® STYLE GROUND CLAMP	500 AMP
GCL200	LENCO® STYLE GROUND CLAMP	200 AMP
GCL300	LENCO® STYLE GROUND CLAMP	300 AMP
GCL500	LENCO® STYLE GROUND CLAMP	500 AMP

Item Number	Style	Amp
GCT200	TWECO® STYLE GROUND CLAMP	200 AMP
GCT300	TWECO® STYLE GROUND CLAMP ECTWC30	300 AMP
GCT500	TWECO® STYLE GROUND CLAMP	500 AMP
GCWAK200	WAK200 STEEL GROUND CLAMP	200 AMP
GCWAK300	WAK300 STEEL GROUND CLAMP	300 AMP
GCWAK500	WAK500 STEEL GROUND CLAMP	500 AMP
MIG300	GROUND C-CLAMP MIG STYLE	300 AMP
ASMG300	MAGNETIC GROUND CLAMP	300 AMP

ARC Star™ Welding Cable

ARC Star™ offers a variety of welding cable assemblies in sizes 4, 2, 1, 1/0, 2/0, 3/0, and 4/0. We have leads, grounds, and extensions in any length and configuration. We also offer cut cable in multiple lengths without ends. We can supply ground clamps, electrode holders, lugs, and cable connectors with our proprietary ARC Star™ brands on the ends or OEM's such as, Tweco®, for any of the assemblies you may need. If you have a bulk buy or just need one assembly we can take care of all of your needs.

Features:

- Premium American made welding cable
- Available in custom cut sections fully assembled with ends
- Boxed cable kits optimized for shipping and display
- Private labeling available with minimum order quantities
- Only the highest quality cable accessories are used in our custom cable kits

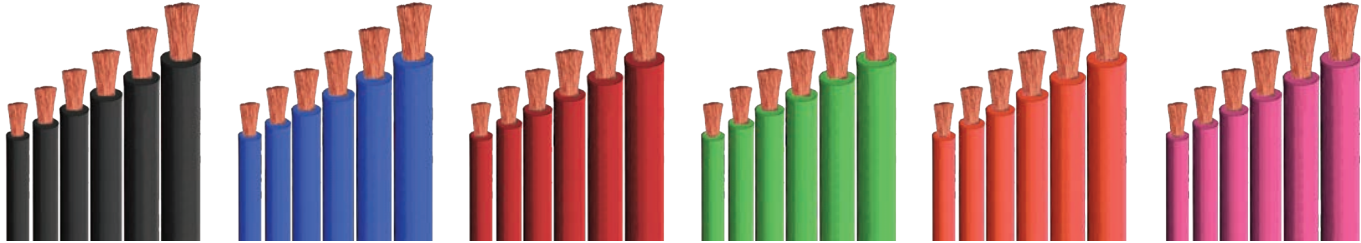

Customize your ARC Star™ Whips / Stinger Assemblies and Ground Assemblies

Cable Type								
Diameters	Colors	Cables	Diameters	Colors	Cables	Diameters	Colors	Cables
#1/0	BLACK	PRE10B250	#2/0	BLACK	PRE20B250	#3/0	BLACK	PRE30B250
#1/0	RED	PRE10R250	#2/0	RED	PRE20R250	#3/0	BLACK	PRE30
#1/0	BLACK	PRE10	#2/0	BLACK	PRE20	#3/0	BLUE	PRE30BLUE
#1/0	RED	PRE10R	#2/0	BLACK	PRE20METER	#3/0	RED	PRE30R
#1/0	BLUE	PRE10BLUE	#2/0	PINK	PRE20P	#3/0	BLACK	PRE30B1000
#1/0	BLACK	PRE10METER	#2/0	RED	PRE20R	#4/0	BLACK	PRE40B250
#1	BLACK	PRE1B250	#2/0	YELLOW	PRE20Y	#4/0	BLACK	PRE40
#1	BLACK	PRE1	#2	BLACK	PRE2B250	#4/0	BLACK	PRE40B1000
#1	RED	PRE1R	#2	BLACK	PRE2	#4	BLACK	PRE4B250
			#2	RED	PRE2R	#4	BLACK	PRE4

(All cable lengths more than 10,000 ft can only be black. Color cable available upon request if not in stock, only for 10,000 ft minimum orders.)

Connection End Parts

Cable Connectors									
RTP1AF	RTP1MBPF	RTP1MBPM	RTP1MBP	RTP2MBPF	RTP2MBPM	RTP2MBP	RTP21MBP	RTP4MBPF	RTP4MBPM
RTP4MBP	RTPLC40	RTPLC40HD	RTPLTC40	CCD1025F	CCD1025M	CCD3550F	CCD3550M	CCD3550	CCD5070F
CCD5070M	CCD5070	CCD7095F	CCD7095M	CCD7095					

Electrode Holders									
EHB400	EHB600	EJH300	EJH500	EHRAF200	EHRAF250	EHRAF300	EHRAF500	EHT200	EHT250
EHT300	EHT350	EHT500	EHT600						

Ground Clamps									
GCL300	GCL500	GCT200	GCT300	GCT500	GCWAK200	GCWAK300	GCWAK500	MIG300	

Lugs									
RTP1020	RTP2AF	RTP20F	RTP3040	RTPS3040	RTP62SPLICERH	RTP60H	RTP62	RTP62H	RTP1020H

OEM item substitutions are also available upon request!

(Continued on next page)

Full Cable Reels

Item Number	Cable	Color	Length
PRE10B250	#1/0 REEL WELDING CABLE	BLACK	250 FT
PRE10R250	#1/0 REEL WELDING CABLE	RED	250 FT
PRE10	#1/0 REEL WELDING CABLE	BLACK	500 FT
PRE10R	#1/0 REEL WELDING CABLE	RED	500 FT
PRE10BLUE	#1/0 ON WELDING CABLE	BLUE	500 FT
PRE10METER	#1/0 REEL WELDING CABLE	BLACK	100 M
PRE1B250	#1 REEL WELDING CABLE	BLACK	250 FT
PRE1	#1 REEL WELDING CABLE	BLACK	500 FT
PRE1R	#1 REEL WELDING CABLE	RED	500 FT
PRE20B250	#2/0 REEL WELDING CABLE	BLACK	250 FT
PRE20R250	#2/0 REEL WELDING CABLE	RED	250 FT
PRE20	#2/0 REEL WELDING CABLE	BLACK	500 FT
PRE20METER	#2/0 REEL WELDING CABLE	BLACK	100 M
PRE20P*	#2/0 REEL WELDING CABLE	PINK	500 FT

Item Number	Cable	Color	Length
PRE20R	#2/0 REEL WELDING CABLE	RED	500 FT
PRE20Y*	#2/0 REEL WELDING CABLE	YELLOW	500 FT
PRE2B250	#2 REEL WELDING CABLE	BLACK	250 FT
PRE2	#2 REEL WELDING CABLE	BLACK	500 FT
PRE2R	#2 REEL WELDING CABLE	RED	500 FT
PRE30B250	#3/0 REEL WELDING CABLE	BLACK	250 FT
PRE30	#3/0 REEL WELDING CABLE	BLACK	500 FT
PRE30R	#3/0 REEL WELDING CABLE	RED	500FT
PRE30B1000	#3/0 REEL WELDING CABLE	BLACK	1000 FT
PRE40B250	#4/0 REEL WELDING CABLE	BLACK	250 FT
PRE40	#4/0 REEL WELDING CABLE	BLACK	500 FT
PRE40B1000	#4/0 REEL WELDING CABLE	BLACK	1000 FT
PRE4B250	#4 REEL WELDING CABLE	BLACK	250 FT
PRE4	#4 REEL WELDING CABLE	BLACK	500 FT

*10,000FT MOQ.

Custom cut lengths available with MOQ

ARC Star™ Revolution Lead Reels

Arc Star™ Revolution Lead Reels! A revolutionary high quality yet low cost lead reel that will surely change a welder's experience. By bringing affordable lead reels to market now even the "helpers" will have a lead reel. With heavy duty powder coated paint job and premium construction the Arc Star™ lead reels are sure to impress even the most critical rig welders. All this at a price point nearly half of the competition! Don't miss out on being part of the revolution!

Features

- Stays connected to the welder at all times. "Live Reel Setup"
- Heavy-duty manual friction brake is adjustable, allows the user to set tension and prevents free spooling of leads during roll out
- Comes standard with 400 amp spool isolators
- Heavy-duty, all-steel construction
- Ball bearing spools
- Locking pull pins secure cables while not in use
- Vented spool design allows for free air flow over your head to aid in cooling
- Replacement parts available
- Powder coated for a lasting finish
- All hardware is zinc-coated Grade 5 steel



ASCRFBD10



ASCRFBSSET10



ASCRFBS12

Complete Reels

Item Number	Description	Cable Capacity (Per Spool)
ASCRFBD10	10" DOUBLE CABLE REELS WITH FIXED BASE	150' OF 1/0 OR 125' OF 2/0 CABLE
ASCRFBD10T	10" DOUBLE CABLE REELS WITH FIXED BASE, 12° TILT	150' OF 1/0 OR 125' OF 2/0 CABLE
ASCRFBD12	12" DOUBLE CABLE REELS WITH FIXED BASE	200' OF 1/0 OR 175' OF 2/0 CABLE
ASCRFBD12T	12" DOUBLE CABLE REELS WITH FIXED BASE, 12° TILT	200' OF 1/0 OR 175' OF 2/0 CABLE
ASCRSBD10	10" DOUBLE CABLE REELS WITH SWIVEL BASE	150' OF 1/0 OR 125' OF 2/0 CABLE

Item Number	Description	Cable Capacity (Per Spool)
ASCRSBD12	12" DOUBLE CABLE REELS WITH SWIVEL BASE	200' OF 1/0 OR 175' OF 2/0 CABLE
ASCRFBS10	10" SIDE-BY-SIDE CABLE REELS WITH FIXED BASE	150' OF 1/0 OR 125' OF 2/0 CABLE
ASCRFBS12	12" SIDE-BY-SIDE CABLE REELS WITH FIXED BASE	200' OF 1/0 OR 175' OF 2/0 CABLE
ASCRFBSSET10	10" CABLE REELS, 1 SET OF 2 REELS WITH FIXED BASE	150' OF 1/0 OR 125' OF 2/0 CABLE
ASCRFBSSET12	12" CABLE REELS, 1 SET OF 2 REELS WITH FIXED BASE	200' OF 1/0 OR 175' OF 2/0 CABLE

(Continued on next page)

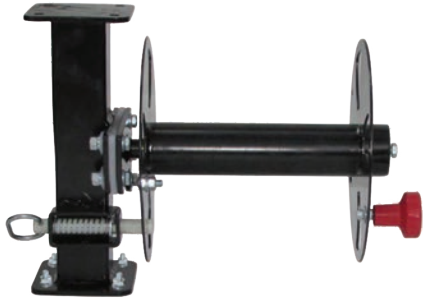

ASCRMODV10

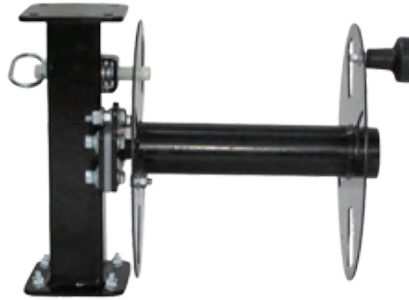

ASCRMODV12



ASCRBSS

Modular Reels and Stands

Item Number	Description
ASCRMODV10	REVOLUTION 10" MODULAR VERTICAL CABLE REEL
ASCRMODV12	REVOLUTION 12" MODULAR CABLE REEL
ASCRBSS	REVOLUTION MODULAR SIDE BY SIDE BASE

Item Number	Description
ASCRBT	REVOLUTION MODULAR TILTED BASE
ASCRBV	REVOLUTION MODULAR VERTICAL BASE
ASCRSTAND	REVOLUTION LEAD REEL STAND 18" HIGH



ASCRFBD10

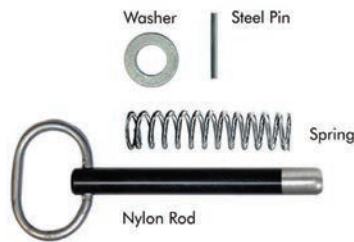

ASCRFBD10



ASCRFBD10

Accessories & Replacement Parts

Item Number	Description
ASCRCOVERFBD	RAIN COVER FOR MODELS: ASCRFBD10 & 12, ASCRSBD10 & 12
ASCRCOVERFBS	RAIN COVER FOR FIXED SINGLE MODELS: ASCRFBSSET10 & SET12
ASCRCOVERFBSS	RAIN COVER FOR FIXED SIDE BY SIDE MODELS: ASCRFBS10 & 12
ASCRBOIS	.55 BOLT ISOLATORS FOR REVOLUTION LEAD REELS
ASCRHW380.75	BOLT (INCLUDES NUT) FOR CABLE CONNECTION TO DISC
ASCRHW381.25	REPLACEMENT BREAK BOLT (INCLUDES NUT)

Item Number	Description
ASCRHWI22.0FT	BOLT KIT (INCLUDES NUTS AND WASHERS) FOR CABLE CONNECTION TO THE FRAME
ASCRHW381.5PT	BOLT KIT (INCLUDES NUTS AND WASHERS) FOR SPOOL ISOLATORS
ASCRKNOBB	BLACK HAND KNOB FOR REVOLUTION LEAD REEL
ASCRKNOBR	RED HAND KNOB FOR REVOLUTION LEAD REELS
ASCRPPKIT	REPLACEMENT PIN FOR REVOLUTION LEAD REELS (INCLUDES SPRING, WASHER, SPRING PIN)
ASCRSPIS600	SPIS600 600 AMP SPOOL ISOLATOR FOR REVOLUTION REELS

ARC Star™ Cable Connectors

ARC Star™ cable connectors are designed to efficiently conduct the current through a detachable type connector. Brass bodies are precision machined from heavy specially shaped brass extrusion. The positive lock-tight action known as, Cam action design, allows lock in with a twist and pulls the two halves together tightly. Connector covers are resistant to heat, cold, abrasion, ozone, oils & solvents. Tapered ends lock out moisture, oil and dirt. Connector covers are specially compounded to be flame retardant. Terminal connectors replace cable lugs for fixture to machines allowing for quick disconnect of cables.:

Features • Premium quality brass connectors • Machined from brass alloy bar stock • Interchangeable with Tweco® connectors • Heat and oil resistant covers



Tweco® Style Cable Connectors

Item Number	Description
RTP1AF	1AF FEMALE TERMINAL (TE-10F)
RTP1MBPF	#1 TWECO® STYLE MBP CABLE CONNECTOR FEMALE END
RTP1MBPM	#1 TWECO® STYLE MBP CABLE CONNECTOR MALE END
RTP1MBP	#1 TWECO® STYLE MBP CABLE CONNECTOR SET
RTP2MBPF	#2 TWECO® STYLE MBP CABLE CONNECTOR FEMALE END
RTP2MBPM	#2 TWECO® STYLE MBP CABLE CONNECTOR MALE END
RTP2MBP	#2 TWECO® STYLE MBP CABLE CONNECTOR SET
RTP21MBP	#2 TWECO® STYLE MBP WHIP CABLE CONNECTOR MALE END
RTP4MBPF	#4 TWECO® STYLE MBP CABLE CONNECTOR FEMALE END
RTP4MBPM	#4 TWECO® STYLE MBP CABLE CONNECTOR MALE END
RTP4MBP	#4 TWECO® STYLE MBP CABLE CONNECTOR SET
RTPLC40	LENCO® STYLE CABLE CONNECTORS LC-40
RTPLC40HD	LENCO® STYLE CABLE CONNECTORS LC-40 M/F SET

Item Number	Description
RTPLTC40	CABLE SPLITTER/CONNECTOR, 1 MALE, TWO FEMALE DINSE STYLE ADAPTER
CCD1025F	DINSE CABLE CONNECTOR FEMALE 1025-F (CABLE 8-4)
CCD1025M	DINSE CABLE CONNECTOR MALE 1025-M (CABLE 8-4)
CCD3550F	DINSE CABLE CONNECTOR FEMALE 3550-F (#4-1/0)
CCD3550M	DINSE CABLE CONNECTOR MALE 3550-M (#4-1/0)
CCD3550	DINSE CABLE CONNECTOR SET (#4-1/0)
CCD5070F	DINSE CABLE CONNECTOR FEMALE 5070-F (1/0-2/0)
CCD5070M	DINSE CABLE CONNECTOR MALE 5070-M (1/0-2/0)
CCD5070	DINSE CABLE CONNECTOR 5070 SET (1/0-2/0)
CCD7095F	DINSE CABLE CONNECTOR FEMALE 7095-F (2/0-4/0)
CCD7095M	DINSE CABLE CONNECTOR MALE 7095-F (2/0-4/0)
CCD7095	DINSE CABLE CONNECTOR 7095 (2/0-4/0)
DA5095	400 AMP EURO CABLE CONNECTOR (1/0-3/0)

ARC Star™ Cable Lugs

Features: • Premium quality brass connectors • Machined from brass alloy bar stock • Interchangeable with Tweco® connectors • Heat and oil resistant covers

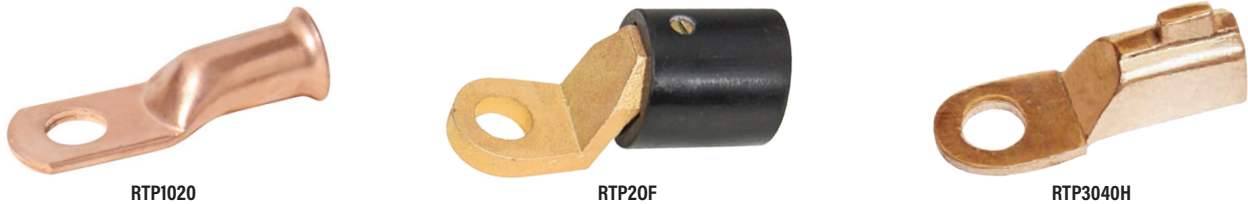

Item Number	Description
RTP1020	CABLE LUG FOR 1/0-2/0 CABLE
RTP2AF	2AF FEMALE TERMINAL LUG - 45° ANGLE (10/CASE)
RTP20F	20F FEMALE TERMINAL LUG - 180° OFF SET
RTP3040	CABLE LUG FOR 3/0-4/0 CABLE (10/CASE)
RTPS3040	CABLE SPLICER FOR 3/0-4/0 CABLE
RTP1020SPLICERH	CABLE SPLICER FOR 1/0-2/0 CABLE HAMMER ON
RTP3040SPLICERH	CABLE SPLICER FOR 3/0-4/0 CABLE HAMMER ON

Item Number	Description
RTP62SPLICERH	CABLE SPLICER FOR 6-2 CABLE HAMMER ON
RTP60H	CABLE LUG #6 - #1 CABLE - HAMMER STYLE (10/CASE)
RTP62	CABLE LUG #6 TO #1 CABLE (10/CASE)
RTP62H	CABLE LUG #6 - #2 CABLE - HAMMER STYLE (10/CASE)
RTP1020H	CABLE LUG #1/0 - #2/0 - HAMMER STYLE
RTP3040H	CABLE LUG #3/0 - #4/0 - HAMMER STYLE (10/CASE)
TECCM20	CRIMPING TOOL, SECURES CABLE ONTO LUG

ARC Star™ Gouging Torch & Carbons

ARC Star's™ copper-coated gouging carbons contain a specially formulated blend of graphite and carbon, which produces one of the most efficient performance of metal removal in today's market place.

Gouging Torch

Features:

- Tested to EN 60974-7 CE
- 7ft Cord (2.1M)
- Compatible with Arc Air™ replacement parts and insulators
- High-temperature resistant handle with high quality copper alloy internals



Item Number	Description
TECK4	ARC STAR™ TYPE 4 ARC GOUGING TORCH
TECK4HANDLE	REPLACEMENT HANDLE
TECK4HEAD	REPLACEMENT HEAD
TECK4INS	REPLACEMENT INSULATOR SET
TECK4LEAD	REPLACEMENT LEAD

ARC Star's™ gouging carbon electrodes are designed for use in the air carbon-arc metal removal process which melts metal with an electric arc, then blows it away with compressed air. When it's important to save the metal pieces that have been welded together, carbon-ar gouging is an absolute lifesaver!

All our gouging carbons come with a thick layer of copper shell surrounding the high density carbon. This results in strengthened arc stability and more efficient current transfer to get the job done quicker!

We know projects come in all shapes and sizes, so we offer a full range of gouging carbon electrodes. Based on the type of angle or joint you need to get into, or how important slag cleanup is to you, you can pic from our assortment of DC, Hollow DC, Flat DC and Jointed DC gouging carbons.



CCC12512



CCC18712H

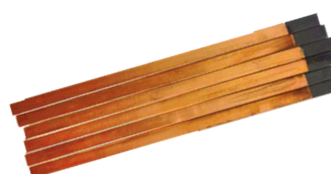

CCC62518712

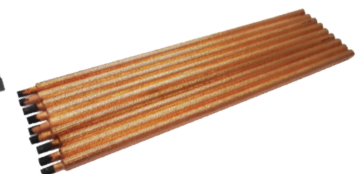

CCC62518712

DC Gouging Carbons

Our standard, all-purpose gouging carbon electrodes all come with copper coating to help improve electrical conductivity for cooler operating conditions. It also makes the carbon more resistant to breakage, heat and oxidation.

Item Number	Diameter	Length	Pkg Qty
CCC12512	1/8"	12"	100
CCC15612	5/32"	12"	100
CCC18712	3/16"	12"	50
CCC25012	1/4"	12"	50

Item Number	Diameter	Length	Pkg Qty
CCC31212	5/16"	12"	50
CCC37512	3/8"	12"	50
CCC50012	1/2"	12"	50

Hollow DC Gouging Carbons

Hollow core gouging carbons can carry 15-20% increased current, which offers excellent arc stability while allowing for 40% faster removal than solid rods.

The hollow core design prevents fingernailing, or formation of a fragile pointed tip which occurs when using solid rods. When this tip falls into the gouge, it has to be cleaned up and redone. Hollow carbons create a smooth U-groove, and don't drop unnecessary carbon, making the job faster. These carbons function more silently, burn cleaner and produce much less smoke than standard rods.

Item Number	Diameter	Length	Pkg Qty
CCC18712H	3/16"	12"	50
CCC25012H	1/4"	12"	50
CCC31212H	5/16"	12"	50

Item Number	Diameter	Length	Pkg Qty
CCC37512H	3/8"	12"	50
CCC50012H	1/2"	12"	50

Flat DC Gouging Carbons

Our flat gouging carbons were specifically tailored for close quarters - when you have to remove metal with a real close tolerance. They're also great to use for general applications, repairing or making dies, scarfing billets, removing weld crown, and more.

Item Number	Width	Height	Length	Pkg Qty
CCC37515612	3/8"	5/32"	12"	50

Item Number	Width	Height	Length	Pkg Qty
CCC62518712	5/8"	3/16"	12"	50

Jointed DC Gouging Carbons

If you need a continuous feed for quicker operation, especially in production operations, or machine-fed operations, jointed gouging carbon solutions are perfect! Our gouging carbons allow machines to work fast and efficiently by operation in a smooth forward motion rather than being wasteful by going back and forth. The joints fit tightly together and allow for more efficient current transfer. Loose fitting rods have a tendency to heat up and prematurely break off during gouging.

Item Number	Diameter	Length	Pkg Qty
CCCJ37517	3/8"	17"	50
CCCJ50017	1/2"	17"	50

Item Number	Diameter	Length	Pkg Qty
CCCJ62517	5/8"	17"	25
CCCJ75017	3/4"	17"	50

Gouging Carbon Consumption And Electrical Requirements

Electrode Size		Min. Amp	Max. Amp
Inch	MM		
1/8"	3	60	90
5/32"	4	90	150
3/16"	5	200	250
1/4"	6	300	400
5/16"	8	350	450

Electrode Size		Min. Amp	Max. Amp
Inch	MM		
3/8"	10	450	600
1/2"	13	800	1000
5/8"	16	1000	1250
3/4"	19	1250	1600
1"	25	1600	2200

Chamfer Cutting Rods

ARC Star's Cut Rods are specially designed electrodes for chamfering, gouging, and beveling of all metals.

Features:

- Heavier flux than other electrodes to protect the core from overheating due to high amperages, and also produce more gas to remove more material per electrode

- Can be used with any AC or DC welding machine. Does not require any special equipment such as an air compressor or expensive gases.

Item Number	Description	Pkg Qty
CCCM71125	M-71 CHAMFER ROD 1/8" DIAMETER	10 LB PLASTIC TUBE
CCCM71156	M-71 CHAMFER ROD 5/32" DIAMETER	8 LB PLASTIC TUBE

Item Number	Description	Pkg Qty
CCCM71187	M-71 CHAMFER ROD 3/16" DIAMETER	1 LB PLASTIC TUBE

ARC Star™ Canisters

Features: 1 - Cap retention chain 2 - Rubber O-ring for airtight seal 3 - Carrying Strap 4 - Belt clip 5 - Embossed with a conversion table and ruler

Item Number	Description
ASRGR100	RED 10# ELECTRODE HOLDER
ASRGB100	BLUE 10# ELECTRODE HOLDER
ASRGR300	RED 36" TIG ROD CANISTER
ASRGB300	BLUE 36" TIG ROD CANISTER
ASRGB100-O-RING	RED 10# ELECTRODE HOLDER O-RING



ASRGR100 & ASRGB100

ARC Star™ Rap-Arounds

ARC Star's™ RAP-AROUNDS come in both Plain Edge and Tuff-Edge®. Tuff-Edge® feature covers the leading ruled edge with a tough, clear vinyl cover. The material is highly abrasion resistant, heat resistant, and adds extra long life to the product by protecting the ruled surface and the edge.

Item Number	Edge	Length
ASRA150	RAP-AROUND 150	2 FT
ASRA150TE	RAP-AROUND 170 TOUGH EDGE	2 FT
ASRA170	RAP-AROUND 170	6 FT
ASRA170TE	RAP-AROUND 170 TOUGH EDGE	6 FT

Item Number	Edge	Length
ASRA177	RAP-AROUND 177	7 FT
ASRA177TE	RAP-AROUND 177 TOUGH EDGE	7 FT
ASRA179	RAP-AROUND 179	9 FT
ASRA179TE	RAP-AROUND 179 TOUGH EDGE	9 FT



ARC Star™ Rod Ovens

Features:

- Analog thermostats
- Each oven is tested and heated to rated temperature before being supplied
- Calibration Certificates are available upon request
- Stainless steel body ovens
- Voltages offered are: 110V and 220V
- High temperature resistant handle with High quality copper alloy internals
- Dual voltage ovens
- Digital temperature controllers
- Bench oven and flux oven models are fitted with mini-circuit breakers for safety
- All oven models are tested to BS 638.5 and EN 60974-1 norms

Portable Electrode Ovens

Type 1	<ul style="list-style-type: none"> • Dual voltage heating element operates between 100-240V while providing consistent oven temperature • Steady state operation reduces power consumption • Removable cord secured to oven by locking power inlet allows for easy replacement if damaged • Insulated lid easily secures with a latch
Type 2	<ul style="list-style-type: none"> • Dual voltage heating element operates between 100-240V while providing consistent oven temperature • Removable cord secured to oven by locking power inlet allows for easy replacement if damaged
Type 5/5A	<ul style="list-style-type: none"> • Wire wrapped heating elements provide consistent oven temperature • Removable cord secured to oven by locking power inlet allows for easy replacement if damaged • Carry handles or wheels and handle available



PARAMETERS	ASPE1	ASPE2	ASPE5	ASPE5A
Electrode Capacity	10lbs	20lbs	50lbs	50lbs
Heating Element	235W Wire Wrap	600W Wire Wrap	700W Wire Wrap	700W Wire Wrap
Working Voltage	AC 240V AC/DC 60V-120V			
Temperature Range	300°F (150°C)	120°F-300°F (50°C -150°C)	120°F-300°F (50°C -150°C)	120°F-300°F (50°C -150°C)
Thermostat	Preset	Adjustable Thermostat with High Limit Switch		
Electrode Length	19.7" (500mm)	19.7" (500mm)	19.7" (500mm)	19.7" (500mm)
Weight	9.37lbs	11.24lbs	28.9lbs	43.54lbs
Overall Size (L x W x H)	180 x 150 x 580mm	215 x 180 x 590mm	360 x 285 x 580mm	400 x 340 x 690mm

(Continued on next page)

Bench Ovens & Electrode Ovens



PARAMETERS	TEC15I	TEC50I	EQ150SIDT	EQ250DT3	EQ250DDT3	EQ450DT3 EQ450DT3240
Electrode Capacity	20lbs	50lbs	150lbs	250lbs	250lbs	450lbs
Max. Electrode Size	18" (457mm)	18" (457mm)	18" (457mm)	18" (457mm)	18" (457mm)	18" (457mm)
Working Voltage	110V, 220V (Standard)	110V, 220V (Standard)	110V, 220V (Standard)	110V, 220V (Standard)	110V, 220V (Standard)	110V, 220V (Standard)
Wattage	250 Watts	350 Watts	750 Watts	1000 Watts	1000 Watts	2000 Watts
Supply Cable Size	18 AWG x 3C	18 AWG x 3C	14 AWG x 3C	14 AWG x 3C	14 AWG x 3C	2.5mm ² x 3C
Temperature Range	Max. 300°F (150°C)	Max. 572°F (300°C)	Max. 572°F (300°C)	Max. 572°F (300°C)	Max. 572°F (300°C)	Max. 572°F (300°C)
Thermostat	Analog	Analog	Analog	Digital temperature controller		
Thermometer	None	None	None			
Heating Element Type	Mica band type	Mica band type	'U' shape tubular	'U' shape tubular	'U' shape tubular	'U' shape tubular
Insulation	25mm ceramic wool	25mm ceramic wool	2" ceramic wool	2" ceramic wool	2" ceramic wool	3" ceramic wool
Outer Size (mm)	590 x 180 x 180	570 x 232 x 232	L610 x W560 x H545	L610 x W665 x H595	L610 x W665 x H595	L610 x W705 x H735
Inner Chamber (mm)	480 x 110 x 110	460 x 150 x 150	L500 x W245 x H270	L500 x W350 x H320	L500 x W350 x H320	L520 x W430 x H420
Inner Basket	Yes	4 Section	2 Section	2 Section	2 Section	4 Section
Body	Pre-galvanized steel sheet, powder coated					
Basket Hooks	Yes	Yes	None	None	None	None
Tilt Stand Feature	Yes	Yes	No	No	No	No
Light Indicator	Yes	Yes	Yes	Yes	Yes	Yes
Shoes	Yes	Yes	Metal	Metal	Metal	Metal
Shape	Square	Round	Square	Square	Square	Square
Handle	Fixed Handle	Fixed Handle	None	None	None	None
Wheel	None	None	None	None	None	None
Net Weight	19.2lbs	29.1lbs	92.6lbs	105.8lbs	123.5lbs	147.7lbs

Rod Oven Parts & Accessories

Item Number	Description
EQ1317MCB	MCB 25A 240V 50HZ MAIN CONTROL BREAKER FOR ROD OVEN
EQ150ELEMENT110	HEATING ELEMENT FOR 150LB AND 250LB ROD OVENS 110V
EQ150ELEMENT220	HEATING ELEMENT FOR 150LB AND 250LB ROD OVENS 220V
EQ450ELEMENT110	HEATING ELEMENT FOR 450LB ROD OVEN 110V
EQDTC90240V	DIGITAL TEMPRATURE CONTROLER 85-270V AC.DC 50/60HZ FOR BENCH OVENS

Item Number	Description
EQHINGE	ROD OVEN REPLACEMENT HINGE, FOR 450, 250 AND 150 ROD OVENS
KEE301023	301023 120V ELEMENT 1000W (K-900)
KEE301038	301038 THERMOSTAT (K-450)
ROPC	ROD OVEN POWER CORD



ARMOUR GUARD

**FOR ALL YOUR FIRE RESISTANT CLOTHING,
HELMETS, AND SAFETY RELATED PRODUCTS**

Helmets & Accessories	17-21
Filter Plates	21-22
Safety Glasses	22-23
Face Shields	23-24
Fire Resistant Clothing	24
Cow Split Leather Clothing	24
Welding, Drivers, Work & Mechanics Gloves	25-32
Anti-Fatigue Mats	33
Rolled Goods	33-34
Welding Blankets	34-36
Welding Screens	36
Safety Debris Nettings	37
Safety Dividers	37

Armour Guard™ Helmets & Accessories



TITAN Welding Helmet

Features:

- Clear Blue View Technology
- 6 Independent Arc Sensors
- UV/IR protection Shade DIN 16
- CE Optical Class: 1/1/1/1
- Switching Speed: 0.1 ms
- Delay can be adjusted from the inside
- Helmet Material: High impact Nylon
- Variables shades 5-8 for Grinding and Cutting and shades 9-14 for Arc Welding
- Total Weight: 1.25 lb (20 oz, 567 g)
- Dual strap headgear with torque ratchet
- 3 Year Warranty

Item Number	Lens Color	ADF Size	Viewing Field	Shell Color
AGTITAN	CLEAR BLUE VIEW	4.5" X 5.25" (115MM X 132MM)	3.5" X 3.85" (89MM X 98MM)	BLACK
REPLACEMENT PARTS				
TWWH03IL - INNER PROTECTIVE LENS		AGTITANOL - OUTER PROTECTIVE LENS		
CR2032 - REPLACEMENT BATTERY				



KNIGHT2.0 Welding Helmet

Features:

- Clear Blue View Technology
- 2 Independent Sensors
- UV/IR protection Shade DIN 16
- Clear State: Shade 4
- Switching Speed: 0.3 ms
- CE Optical Class: 1/1/1/2
- Helmet Material: High impact Nylon
- Delay can be adjusted from the inside
- Total Weight: 1.036 lb (16.58 oz, 470 g)
- Grind Mode & Shade 9-13 Welding Mode Dial
- 3 Year Warranty
- Headgear with torque ratchet

Item Number	Lens Color	ADF Size	Viewing Field	Shell Color
AGKNIGHT2.0	CLEAR BLUE VIEW	5.25" X 4.5" (133.35MM X 114.3MM)	3.89" X 2.64" (100MM X 67MM)	DARK GRAY CARBON FIBER DESIGN
REPLACEMENT PARTS				
AGKNIGHT2.0FILTER - REPLACEMENT FILTER		AGKNIGHT2.0HG - HEAD GEAR		
TWWH03IL - INNER PROTECTIVE LENS		AGL4CP060 - OUTER PROTECTIVE LENS		
CR2032 - REPLACEMENT BATTERY				



GLADIATOR Welding Helmet

Features:

- Clear Blue View Technology
- 4 Independent Sensors
- Flip Front
- UV/IR protection Shade DIN 16
- Clear State: Shade 4
- Switching Speed: 0.3 ms
- CE Optical Class: 1/1/1/2
- Helmet Material: High impact Nylon
- Delay can be adjusted from the inside
- Total Weight: 1.036 lb (16.58 oz, 470 g)
- Grind Mode & Shade 9-13 Welding Mode Dial
- 3 Year Warranty
- Dual strap headgear with torque ratchet

Item Number	Lens Color	ADF Size	Viewing Field	Shell Color
AGGLADIATOR	CLEAR BLUE VIEW	4.33" X 3.54" (90MM X 110MM)	2.08" X 3.85" (53 MM X 98 MM)	BLACK
REPLACEMENT PARTS				
TWWH06IL - INNER PROTECTIVE LENS		TWWH06OL - OUTER PROTECTIVE LENS		
CR2032 - REPLACEMENT BATTERY				



OLYMPUS2.0 Welding Helmet

Features:

- Clear Blue View Technology
- Switching Speed: 0.1 ms
- Variables shades 5-8 for Grinding and Cutting and shades 9-13.5 for Arc Welding
- Meets ANSI Z87.1-2015 Standards
- 4 Independent Arc Sensors
- 3 Year Warranty
- Total Weight: 1.036 lb (16.58 oz, 470 g)
- Headgear with torque ratchet

Item Number	Lens Color	ADF Size	Viewing Field	Shell Color
AGOLYMPUS2.0	CLEAR BLUE VIEW	4.33" X 3.54" (90MM X 110MM)	2.08" X 3.85" (53 MM X 98 MM)	DARK GRAY CARBON FIBER DESIGN
REPLACEMENT PARTS				
AGOLYMPUS2.0FILTER - REPLACEMENT FILTER		AGOLYMPUS2.0HG - HEAD GEAR		
TWWH06IL - INNER PROTECTIVE LENS		AGOLYMPUS2.0OL - OUTER PROTECTIVE LENS		
CR2032 - REPLACEMENT BATTERY				

(Continued on next page)

ARMOUR GUARD



SPARTAN2.0 Welding Helmet

Features:

- Clear Blue View Technology
- 2 Independent Sensors
- UV/IR protection Shade DIN 16
- Clear State: Shade 4
- Switching Speed: 0.3 ms
- CE Optical Class: 1/1/1/2
- Helmet Material: High impact Nylon
- Delay can be adjusted from the inside
- Total Weight: 1.036 lb (16.58 oz, 470 g)
- Grind Mode & Shade 9-13 Welding Mode Dial
- 2 Year Warranty
- Headgear with torque ratchet

Item Number	Lens Color	ADF Size	Viewing Field	Shell Color
AGSPARTAN2.0	CLEAR BLUE VIEW SHADE 9-13 AUTO DARKENING	4.33" X 3.54" (90MM X 110MM)	1.653" X 3.622" (42 MM X 92 MM)	GLOSSY BLACK
REPLACEMENT PARTS				
AGSPARTAN2.0FILTER - REPLACEMENT FILTER		AGSPARTAN2.0HG - HEAD GEAR		
AGSPARTANIL - INNER PROTECTIVE LENS		AGSPARTAN2.00L - OUTER PROTECTIVE LENS		
CR2032 - REPLACEMENT BATTERY				



GRUNT Welding Helmet

Features:

- Reinforced Thermoplastic Hood
- Easy to use removable flip up filter plate design
- Lightweight at 17.9 Ounces (510 Grams)

Item Number	Lens Color	Lens Dimensions	Shell Color
AG2X4WH	COMPATIBLE WITH THE ARMOUR GUARD™ SEER LENS (STANDARD VIEW)	2 IN X 4.25 IN (51 MM X 108 MM)	BLACK
AG4X5WH	COMPATIBLE WITH THE ARMOUR GUARD™ SEER LENS (LARGE VIEW)	4 IN X 4 IN (114 MM X 133 MM)	BLACK



AGKNIGHT2.0HG



AGOLYMPUS2.0HG



AGSPARTAN2.0HG



AGHGDS



TWWHTK04



TWWHCLOOP

Additional Helmet Accessories & Replacement Parts

Item Number	Description
AGHGDS	DUAL STRAP HEADGEAR WITH TORQUE RATCHET
TWWHTK04	HEADGEAR WITH TORQUE RATCHET
TWWHCLOOP	CAP ADAPTER LOOP FOR ALL ARMOUR GUARD HELMETS

Item Number	Description
TWCHINBIB	LEATHER CHIN BIB FOR ALL ARMOUR GUARD HELMETS
TWWHSWEATBAND	SWEATBAND FOR ALL HEADGEAR

Armour Guard™ Helmet Comparison Chart



Part No.	AGSPARTAN2.0	AGOLYMPUS2.0	AGGLADIATOR	AGKNIGHT2.0	AGTITAN
ADF Size	4.33" x 3.54" (110mm x 90mm)	4.33" x 3.54" (110mm x 90mm)	4.33" x 4.49" (90 x 110)	5.25" x 4.5" (133.35mm x 114.3mm)	4.5" x 5.25" (115mm x 132mm)
Viewing Field	3.62" x 1.65" (92 mm x 42 mm)	3.94" x 1.97" (100mm x 50mm)	2.08" x 3.85" (53 mm x 98 mm)	3.89" x 2.64" (100mm x 67mm)	3.5" x 3.85" (89mm x 98mm)
Shade	Clear at Shade 4 Shades 9-13 for welding	Clear at Shade 3 Shades 5-8 for cutting Shades 9-13 for welding	Clear at Shade 4 Shades 5-8 for cutting Shades 9-13 for welding	Clear at Shade 3 Shades 4-8 for cutting Shades 9-13 for welding	Clear at Shade 4 Shades 5-8 for cutting Shades 9-13 for welding
UV/IR Protection	Up to DIN 16	Up to DIN 16	Up to DIN 16	Up to DIN 16	Up to DIN 16
Switching Time	<0.1ms	<0.08ms	0.04 ms	0.04 ms	0.1 ms
Delay Control Time	Inside & Stepless 0.20-0.60s by Dial Knob	Inside & Stepless 0.15-0.80s by Dial Knob	Inside & Digitally Adjustable 0.1-1.0s (9 levels to choose from, and/or automatic control delay time)	Inside & Digitally Adjustable 0.06-1.2s (9 levels to choose from, and/or automatic control delay time)	Inside & Digitally Adjustable 0.1-0.9s (9 levels to choose from, and/or automatic control delay time)
Sensitivity Control	Inside & Stepless Low-High; Adjustable by Dial Knob	Inside & Stepless Adjustable by Dial Knob	Inside & Digitally Adjustable 1-9 (9 levels to choose from, and/or automatic sensitivity adjustment)	Inside & Digitally Adjustable 1-7 (7 levels to choose from, and/or automatic sensitivity adjustment)	Inside & Digitally Adjust- able 1-9 (9 levels to choose from, and/or automatic sensitivity adjustment)
Shade Control	Inside & Stepless	Inside & Stepless	Inside & Digitally Adjustable	Inside & Digitally Adjustable	Inside & Digitally Adjustable
Power Supply	Solar with lithium ion battery backup	Solar & Lithium batteries (2 X CR2032)	Solar & Lithium batteries (2 X CR2032)	Solar & Lithium batteries (2 X CR2032)	Solar with lithium ion battery backup
Operating Temperature	-5°C (23°F) - +55°C (131°F)	-5°C (23°F) - +55°C (131°F)	-5°C (23°F) - +55°C (131°F)	-5°C (23°F) - +55°C (131°F)	-5°C (23°F) - +55°C (131°F)
Storing Temperature	-20°C (-4°F) - +70°C (158°F)	-20°C (-4°F) - +70°C (158°F)	-20°C (-4°F) - +70°C (158°F)	-20°C (-4°F) - +70°C (158°F)	-20°C (-4°F) - +70°C (158°F)
Grind Mode	Yes, Inside	Yes, Inside	Yes, Inside	Yes, Inside	Yes, Inside
TIG Capability	>5A	>5A	>10A	>2A	2A
Arc Sensors	2 Independent Sensors	4 Independent Arc Sensors	4 Independent Sensors	5 Independent Arc Sensors	6 Independent Sensors
Standards	EN 1/1/1/2, ANSI, CSA and AS/NZS	EN 1/1/1/2, ANSI, CSA and AS/NZS	EN 1/1/1/2, ANSI, CSA and AS/NZS	EN 1/1/1/1, ANSI, CSA and AS/NZS	EN 1/1/1/1, ANSI, CSA and AS/NZS
Helmet/ADF Weight Total	14.64 oz	14.4 oz	20 oz	18.4 oz.	20 oz
Technology	CLEAR BLUE VIEW	CLEAR BLUE VIEW	CLEAR BLUE VIEW	CLEAR BLUE VIEW	CLEAR BLUE VIEW
Material	Polypropylene (PP)	Ceramic coated nylon material with carbon fiber design	High Impact Nylon	Ceramic coated nylon material with carbon fiber design	High Impact Nylon
Headgear	Headgear with torque ratchet	Headgear with torque ratchet (Patented strap design for even weight distribution)	Dual strap with torque ratchet	Headgear with torque ratchet (Patented strap design for even weight distribution)	Dual strap with torque ratchet
Warranty	2 Years - Against manufacturer defects.	3 Years - Against manufacturer defects.	3 Years - Against manufacturer defects.	3 Years - Against manufacturer defects.	3 Years - Against manufacturer defects.

(Continued on next page)

ARMOUR GUARD



AGHOTHEADCLIP



AGHOTHEAD



AGHOTHEADFILTER

HOT HEAD Helmet Ventilation System

Features:

- Reduces fumes by up to 90%
- Time saved not having to clean the lens or wipe away sweat
- Healthier breathing environment due to less fumes
- Lightweight device reduces fatigue
- Improves visibility through the helmet reduces errors
- Comfortable working environment improves morale
- No cords or air hose to deal with
- Portable & fits any welding helmet

Item Number	Description	Pkg Qty
AGHOTHEAD	ARMOUR GUARD HOT HEAD HELMET VENTILATION AND COOLING SYSTEM	1
AGHOTHEADEURO	ARMOUR GUARD HOT HEAD HELMET VENTILATION AND COOLING SYSTEM-EURO STYLE	1
AGHOTHEADCLIP	CARBON FIBER CLIP FOR ARMOUR GUARD HOT HEAD	1
AGHOTHEADFILTER	REPLACEMENT FILTERS WITHOUT HOUSING FOR ARMOUR GUARD HOT HEAD	10
AGHOTHEADFILTERWH	REPLACEMENT FILTERS WITH HOUSING FOR ARMOUR GUARD HOT HEAD	3
AGHOTHEADCABLE	CHARGING CABLE FOR ARMOR GUARD HOT HEAD	1
AGHOTHEADPLUG	WALL OUTLET ADAPTER FOR ARMOUR GUARD HOT HEAD	1
AGHOTHEADBUMPONS	BUMP ONS FOR ARMOR GUARD HOT HEAD	1



AGSEER2X4H09EA

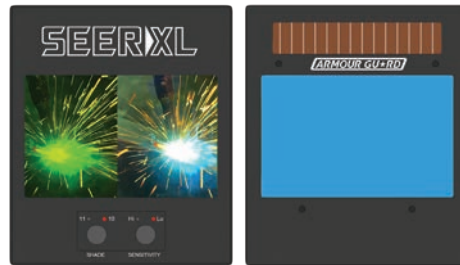

AGSEERXLEA



AGCLAIRVOYANT

SEER Auto-Darkening Filter with Clear Blue View Technology



Features:

- Incredible Clarity
- 2 Independent Arc Sensors
- EQC Quick Change
- Enhanced Definition
- Auto-On/Auto-Off Circuitry
- Meets ANSI Z87.1-2015 and CE 379
- Reduced Eye and Neck Fatigue
- Inner and Outer Cover Plates
- 1 Year Limited Warranty

Item Number	Description	Lens	Shade	Size	Pkg Qty
AGSEER2X4H09EA	SEER AUTO DARKENING FILTER	CLEAR BLUE VIEW	SHADE 9	2 IN X 4-1/4 IN	1
AGSEER2X4H10EA	SEER AUTO DARKENING FILTER	CLEAR BLUE VIEW	SHADE 10	2 IN X 4-1/4 IN	1
AGSEER2X4H11EA	SEER AUTO DARKENING FILTER	CLEAR BLUE VIEW	SHADE 11	2 IN X 4-1/4 IN	1
AGSEER2X4H12EA	SEER AUTO DARKENING FILTER	CLEAR BLUE VIEW	SHADE 12	2 IN X 4-1/4 IN	1

SEER XL Auto-Darkening Filter with Clear Blue View Technology

Features:

- Clear Blue View Technology
- Reduced Eye and Neck Fatigue
- Sensitivity Hi/lo Button Adjustment
- Inner and Outer Cover Plates
- Incredible Clarity
- 4 Independent Arc Sensors
- Designed for Welding < 250 Amp
- Meets ANSI Z87.1-2015 and CE 379
- Enhanced Definition
- Shade 10/11 Button Adjustment
- Auto-On/Auto-Off Circuitry
- 1 Year Limited Warranty

Item Number	Description	Lens	Shade	Size	Pkg Qty
AGSEERXLEA	SEER XL AUTO DARKENING FILTER	CLEAR BLUE VIEW	SHADE 10 & 11	4-1/2 IN X 5-1/4 IN	1
AGSEERXLIL	SEER XL REPLACEMENT INNER LENS (PACK OF 2)	-	-	4-1/2 IN X 5-1/4 IN	2

(Continued on next page)

CLAIRVOYANT Multi Shade Auto-Darkening Filter Lens



Features:

- Ultra Light
- Ultra Thin
- Ultrafast Switching Speed: 1/16000th Sec
- Flicker-Free TIG Welding
- 2 Year Warranty
- Stainless Steel Reflects Heat & Stays Cool
- Crystal Clear Blue View Technology
- 1/1/2 Optical quality
- Shade: Clear at Shade 3
- Dark at Shade 5 for cutting
- Darkest at Shades 8-13 for welding

Item Number	Description	Lens	Shade	Size	Pkg Qty
AGCLAIRVOYANT	CLAIRVOYANT MULTI SHADE AUTO DARKENING FILTER LENS	CLEAR BLUE VIEW	MULTI SHADE	2 IN X 4-1/4 IN	1
AGCLAIRVOYANTIL	AGCLAIRVOYANT INNER LENS WITH 3 HOLES. 0.5 MM THICK			2 IN X 4-1/4 IN	1
AGCLAIRVOYANTBATT	AGCLAIRVOYANT REPLACEMENT CR927 BATTERY				10

Armour Guard™ Filter Plates

- Premium Optical Clarity
- Universal Compatibility
- Meets or exceeds ANSI Z87.1, CE, and other international Certification specifications
- Made from Impact resistant materials

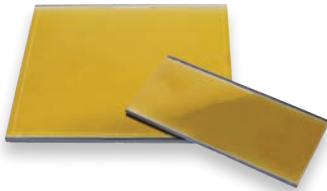

AGL2GH10



AGLP2H10



AGL50CG



AGLMAG200G

GLASS LENSES

Item Number	Description	Shade	Size
AGL2H03	GLASS FILTER LENS	SHADE 3	2 IN X 4-1/4 IN
AGL2H04	GLASS FILTER LENS	SHADE 4	2 IN X 4-1/4 IN
AGL2H05	GLASS FILTER LENS	SHADE 5	2 IN X 4-1/4 IN
AGL2H06	GLASS FILTER LENS	SHADE 6	2 IN X 4-1/4 IN
AGL2H07	GLASS FILTER LENS	SHADE 7	2 IN X 4-1/4 IN
AGL2H08	GLASS FILTER LENS	SHADE 8	2 IN X 4-1/4 IN
AGL2H09	GLASS FILTER LENS	SHADE 9	2 IN X 4-1/4 IN
AGL2H10	GLASS FILTER LENS	SHADE 10	2 IN X 4-1/4 IN
AGL2H11	GLASS FILTER LENS	SHADE 11	2 IN X 4-1/4 IN
AGL2GH12	GLASS FILTER LENS	SHADE 12	2 IN X 4-1/4 IN
AGL2H12	GLASS FILTER LENS	SHADE 12	2 IN X 4-1/4 IN
AGL2H13	GLASS FILTER LENS	SHADE 13	2 IN X 4-1/4 IN
AGL2H14	GLASS FILTER LENS	SHADE 14	2 IN X 4-1/4 IN

Item Number	Description	Shade	Size
AGL4H04	GLASS FILTER LENS	SHADE 4	4-1/2 IN X 5-1/4 IN
AGL4H05	GLASS FILTER LENS	SHADE 5	4-1/2 IN X 5-1/4 IN
AGL4H06	GLASS FILTER LENS	SHADE 6	4-1/2 IN X 5-1/4 IN
AGL4H07	GLASS FILTER LENS	SHADE 7	4-1/2 IN X 5-1/4 IN
AGL4H08	GLASS FILTER LENS	SHADE 8	4-1/2 IN X 5-1/4 IN
AGL4H09	GLASS FILTER LENS	SHADE 9	4-1/2 IN X 5-1/4 IN
AGL4H10	GLASS FILTER LENS	SHADE 10	4-1/2 IN X 5-1/4 IN
AGL4H11	GLASS FILTER LENS	SHADE 11	4-1/2 IN X 5-1/4 IN
AGL4H12	GLASS FILTER LENS	SHADE 12	4-1/2 IN X 5-1/4 IN
AGL4H13	GLASS FILTER LENS	SHADE 13	4-1/2 IN X 5-1/4 IN
AGL4H14	GLASS FILTER LENS	SHADE 14	4-1/2 IN X 5-1/4 IN
AGL4CG	CLEAR GLASS COVER LENS	CLEAR	4-1/2 IN X 5-1/4 IN

PLASTIC LENSES

Item Number	Description	Shade	Size
AGLP2H05	PLASTIC FILTER LENS	SHADE 5	2 IN X 4-1/4 IN
AGLP2H06	PLASTIC FILTER LENS	SHADE 6	2 IN X 4-1/4 IN
AGLP2H08	PLASTIC FILTER LENS	SHADE 8	2 IN X 4-1/4 IN
AGLP2H09	PLASTIC FILTER LENS	SHADE 9	2 IN X 4-1/4 IN
AGLP2H10	PLASTIC FILTER LENS	SHADE 10	2 IN X 4-1/4 IN
AGLP2H11	PLASTIC FILTER LENS	SHADE 11	2 IN X 4-1/4 IN
AGL2GH08	GOLD PLASTIC OMNI VIEW LENS	SHADE 8	2 IN X 4-1/4 IN
AGL2GH09	GOLD PLASTIC OMNI VIEW LENS	SHADE 9	2 IN X 4-1/4 IN
AGL2GH10	GOLD PLASTIC OMNI VIEW LENS	SHADE 10	2 IN X 4-1/4 IN
AGL2GH11	GOLD PLASTIC OMNI VIEW LENS	SHADE 11	2 IN X 4-1/4 IN
AGL2GH12	GOLD PLASTIC OMNI VIEW LENS	SHADE 12	2 IN X 4-1/4 IN

Item Number	Description	Shade	Size
AGLP2H12	PLASTIC FILTER LENS	SHADE 12	2 IN X 4-1/4 IN
AGLP4H09	PLASTIC FILTER LENS	SHADE 9	4-1/2 IN X 5-1/4 IN
AGLP4H10	PLASTIC FILTER LENS	SHADE 10	4-1/2 IN X 5-1/4 IN
AGLP4H11	PLASTIC FILTER LENS	SHADE 11	4-1/2 IN X 5-1/4 IN
AGLP4H12	PLASTIC FILTER LENS	SHADE 12	4-1/2 IN X 5-1/4 IN
AGL2CG	CLEAR GLASS COVER LENS	CLEAR	2 IN X 4-1/4 IN
AGL2CP060	PLASTIC COVER LENS	CLEAR	2 IN X 4-1/4 IN
AGL2CR39	CR39® PLASTIC COVER LENS	CLEAR	2 IN X 4-1/4 IN
AGL2TC	PLASTIC SAFETY PLATE	CLEAR	2 IN X 4-1/4 IN
AGL4CP060	PLASTIC COVER LENS	CLEAR	4-1/2 IN X 5-1/4 IN
AGL4CR39	CR39® PLASTIC COVER LENS	CLEAR	4-1/2 IN X 5-1/4 IN
AGL4TC	PLASTIC SAFETY PLATE	CLEAR	4-1/2 IN X 5-1/4 IN

(Continued on next page)

ARMOUR GUARD

GOLD GLASS LENSES

Item Number	Description	Shade	Size	Item Number	Description	Shade	Size
AGL2GGH08	GOLD GLASS FILTER LENS	SHADE 8	2 IN X 4-1/4 IN	AGL4GGH09	GOLD GLASS LENS	SHADE 09	4-1/2 IN X 5-1/4 IN
AGL2GGH09	GOLD GLASS FILTER LENS	SHADE 9	2 IN X 4-1/4 IN	AGL4GGH10	GOLD GLASS LENS	SHADE 10	4-1/2 IN X 5-1/4 IN
AGL2GGH10	GOLD GLASS FILTER LENS	SHADE 10	2 IN X 4-1/4 IN	AGL4GGH11	GOLD GLASS LENS	SHADE 11	4-1/2 IN X 5-1/4 IN
AGL2GGH11	GOLD GLASS FILTER LENS	SHADE 11	2 IN X 4-1/4 IN	AGL4GGH12	GOLD GLASS LENS	SHADE 12	4-1/2 IN X 5-1/4 IN

GOLD PLASTIC LENSES

Item Number	Description	Shade	Size	Item Number	Description	Shade	Size
AGL4GH08	GOLD PLASTIC OMNI VIEW LENS	SHADE 8	4-1/2 IN X 5-1/4 IN	AGL4GH11	GOLD PLASTIC OMNI VIEW LENS	SHADE 11	4-1/2 IN X 5-1/4 IN
AGL4GH09	GOLD PLASTIC OMNI VIEW LENS	SHADE 9	4-1/2 IN X 5-1/4 IN	AGL4GH12	GOLD PLASTIC OMNI VIEW LENS	SHADE 12	4-1/2 IN X 5-1/4 IN
AGL4GH10	GOLD PLASTIC OMNI VIEW LENS	SHADE 10	4-1/2 IN X 5-1/4 IN				

MAGNIFYING LENSES

Item Number	Description	Shade	Size	Item Number	Description	Shade	Size
AGLMAG075G	0.75 GLASS MAGNIFYING LENS	N/A	2 IN X 4-1/4 IN	AGLMAG75	0.75 PLASTIC MAGNIFYING LENS	N/A	2 IN X 4-1/4 IN
AGLMAG100G	1.00 GLASS MAGNIFYING LENS	N/A	2 IN X 4-1/4 IN	AGLMAG100	1.00 PLASTIC MAGNIFYING LENS	N/A	2 IN X 4-1/4 IN
AGLMAG125G	1.25 GLASS MAGNIFYING LENS	N/A	2 IN X 4-1/4 IN	AGLMAG125	1.25 PLASTIC MAGNIFYING LENS	N/A	2 IN X 4-1/4 IN
AGLMAG150G	1.50 GLASS MAGNIFYING LENS	N/A	2 IN X 4-1/4 IN	AGLMAG150	1.50 PLASTIC MAGNIFYING LENS	N/A	2 IN X 4-1/4 IN
AGLMAG175G	1.75 GLASS MAGNIFYING LENS	N/A	2 IN X 4-1/4 IN	AGLMAG175	1.75 PLASTIC MAGNIFYING LENS	N/A	2 IN X 4-1/4 IN
AGLMAG200G	2.00 GLASS MAGNIFYING LENS	N/A	2 IN X 4-1/4 IN	AGLMAG200	2.00 PLASTIC MAGNIFYING LENS	N/A	2 IN X 4-1/4 IN
AGLMAG225G	2.25 GLASS MAGNIFYING LENS	N/A	2 IN X 4-1/4 IN	AGLMAG225	2.25 PLASTIC MAGNIFYING LENS	N/A	2 IN X 4-1/4 IN
AGLMAG250G	2.50 GLASS MAGNIFYING LENS	N/A	2 IN X 4-1/4 IN	AGLMAG250	2.50 PLASTIC MAGNIFYING LENS	N/A	2 IN X 4-1/4 IN
AGLMAG300G	3.00 GLASS MAGNIFYING LENS	N/A	2 IN X 4-1/4 IN				

ROUND LENSES

Item Number	Description	Shade	Size
AGL50CG	CLEAR GLASS LENS	CLEAR	50 MM
AGL50CP	PLASTIC LENS	CLEAR	50 MM
AGL50H04	FILTER LENS	SHADE 4	50 MM
AGL50H05	FILTER LENS	SHADE 5	50 MM
AGL50H06	FILTER LENS	SHADE 6	50 MM

SLEEVES

Item Number	Description	Shade	Size
AGL2SP	SAFETY PLATE PAPER SLEEVE	N/A	2 IN X 4-1/4 IN
AGL2SPBLANK	SAFETY PLATE PAPER SLEEVE BLANK	N/A	2 IN X 4-1/4 IN
AGL4SP	SAFETY PLATE PAPER SLEEVE	N/A	4-1/2 IN X 5-1/4 IN

Armour Guard™ Safety Glasses

Economically priced with style, comfort, durability, and quality needed to keep your eyes protected.

VIKING Safety Glasses

Features:

- Glossy, lightweight black frames with a wide variety of lens colors such as clear, smoke, IRUV shade 5.0, and indoor/outdoor
- Extra long neck cord included with every pair
- Incredible flexibility and durability for longer life expectancy
- Lens coated with both anti-fog and anti-scratch for longer life expectancy
- Cushioned nose piece for comfort and non-slip security



AG22475



AG25671



AG25679



AG25685

Item Number	Frame/Temples Color	Lens Tint	Coating/Shade	Pkg Qty
AG22475	BLACK	SMOKE	ANTI-FOG/ANTI-SCRATCH	12
AG25671	BLACK	IRUV SHADE 5	ANTI-FOG/ANTI-SCRATCH	12
AG25679	BLACK	CLEAR	ANTI-FOG/ANTI-SCRATCH	12
AG25685	BLACK	INDOOR/OUTDOOR	ANTI-FOG/ANTI-SCRATCH	12

(Continued on next page)

SAVAGE Safety Glasses

Features:

- Meets and exceeds all ANSI Z87.1 specifications
- Strong, lightweight polycarbonate lens with a wide variety of lens colors such as clear, smoke, and indoor/outdoor
- Triple temple support for extra stability
- Incredible flexibility and durability for longer life expectancy
- Filters 99% of UV radiation
- Spatula Lanyard Hole for security of safety glasses and convenience
- Lens coated with anti-scratch for longer life expectancy



AG25627



AG25631



AG25638

Item Number	Frame/Temples Color	Lens Tint	Coating/Shade	Pkg Qty
AG25627	BLACK	CLEAR	UNCOATED	12
AG25631	BLACK	SMOKE	UNCOATED	12
AG25638	BLACK	INDOOR/OUTDOOR	UNCOATED	12

Armour Guard™ Goggle & Other Safety Glasses



AGCVGOGGLES



TSP98120



TSPS2513

Item Number	Frame/Temples Color	Lens Tint	Coating/Shade	Pkg Qty
AGCVGOGGLES	CLEAR - Splash goggle with vents	CLEAR	UNCOATED	12
TSP98120	GREEN	GREEN	UNCOATED	12
TSP9814	YELLOW	YELLOW	UNCOATED	12
TSPS2513	SMOKE	SMOKE	UNCOATED	12
TSPS7311	CLEAR	CLEAR	UNCOATED	12

Armour Guard™ Face Shields

- Features: • Premium optical clarity • Universal compatibility • Meets or exceeds ANSI Z87.1, CE, and other international certification specifications



AGBROWGUARD



AGCUVECON8X12



AGS5BVECON8X12

Item Number	Description	Color	Size
AGBROWGUARD	ARMOUR GUARD BROW GUARD WITHOUT FACE SHIELD	CLEAR	ONE SIZE 50/BOX
AGCUVECON8X12	UNBOUND VISOR	CLEAR	8 IN X 12 1/2 IN X 1/25 IN
AGS5BVECON8X12	BOUND SHADE #5 POLYCARBONATE VISOR	DARK GREEN	8 IN X 12 1/2 IN X 1/25 IN
AGS5UVPREM8X12	UNBOUND SHADE #5 POLYCARBONATE VISOR	DARK GREEN	8 IN X 12 1/2 IN X 1/25 IN

Item Number	Description	Color	Size
AGDGVUECON9X15	UNBOUND VISOR	DARK GREEN	9 IN X 15 1/2 IN X 1/25 IN
AGDGBVECON9X15	BOUND VISOR	DARK GREEN	9 IN X 15 1/2 IN X 1/25 IN
AGLGBVECON9X15	BOUND VISOR	LIGHT GREEN	9 IN X 15 1/2 IN X 1/25 IN
AGS3BVPREM9X15	BOUND SHADE #3 POLYCARBONATE VISOR	DARK GREEN	9 IN X 15 1/2 IN X 1/25 IN

(Continued on next page)

ARMOUR GUARD

AGCUVECON8X15	UNBOUND VISOR	CLEAR	8 IN X 15 1/2 IN X 1/25 IN
AGCUPREM8X15	UNBOUND HEAVY DUTY POLYCARBONATE VISOR	CLEAR	8 IN X 15 1/2 IN X 1/25 IN
AGCBVECON9X15	BOUND CLEAR POLY-CARBONATE VISOR	CLEAR	9 IN X 15 1/2 IN X 1/25 IN
AGCUVECON4199	UNBOUND FACESHIELD (FITS FIBRE METAL BROW GUARD)	CLEAR	9 IN X 15 1/2 IN X 1/25 IN
AGCUVECON9X15	UNBOUND VISOR	CLEAR	9 IN X 15 1/2 IN X 1/25 IN
AGCVECON9X15	BOUND VISOR	CLEAR	9 IN X 15 1/2 IN X 1/25 IN

AGS3UVPREM9X15	UNBOUND SHADE #3 POLYCARBONATE VISOR	DARK GREEN	9 IN X 15 1/2 IN X 1/25 IN
AGS5BVECON9X15	BOUND VISOR	SHADE 5	9 IN X 15 1/2 IN X 1/25 IN
AGS5BVPREM9X15	BOUND HEAVY DUTY SHADE #5 POLYCARBONATE VISOR	DARK GREEN	9 IN X 15 1/2 IN X 1/25 IN
AGS5UVECON9X15	UNBOUND VISOR	SHADE 5	9 IN X 15 1/2 IN X 1/25 IN
AGS5UVPREM9X15	UNBOUND SHADE #5 POLYCARBONATE VISOR	DARK GREEN	9 IN X 15 1/2 IN X 1/25 IN

Armour Guard™ Fire Resistant Clothing

Armour Guard™ by Techniweld USA is the ultimate fire Resistant option for green/orange clothing for the welding and manufacturing industries. Using our factory proprietary process we have created a soft, yet strong, 9oz/yd 100% cotton fire resistant sateen weave which withstands 50+ launderings.



FR9J



FR9B14



FR9CS



AGWC

Item Number	Description	Sizes	Color
FR9J	9 OZ JACKET	SMALL-5X-LARGE	GREEN
FR9B14	9 OZ FLAME BIB (TIE-AROUND)	14 IN	GREEN
FR9B20	9 OZ FLAME BIB (TIE-AROUND)	20 IN	GREEN
FR9BA36	9 OZ BIB APRON	36 IN X 24 IN	GREEN
FR9BA42	9 OZ BIB APRON	42 IN X 24 IN	GREEN
FR9CS	9 OZ CAPE SLEEVE JACKET	SMALL-3X-LARGE	GREEN

Item Number	Description	Size	Color
FR9S18	9 OZ SLEEVE PROTECTORS	18 IN	GREEN
FR9S23	9 OZ SLEEVE PROTECTORS	23 IN	GREEN
FR9S023	9 OZ SLEEVE PROTECTORS	23 IN	ORANGE
AGWC	DOUBLE LAYER 100% COTTON WELDING CAP. NON FIRE RESISTANT	ONE SIZE FITS MOST	BLACK

Armour Guard™ Cow Split Leather Clothing

Features: • Cow split leather • Soapstone pockets • Stitched with Kevlar® threads • Underarm gusset • Brass snaps & rivets • Cotton strap fitting mechanism • RoHS compliant



AGLJ30



AGLCS



AGLS



AGLB

Item Number	Description	Sizes	Color
AGLJ30	30 IN JACKET	SMALL - 4X-LARGE	GOLDEN BROWN
AGLCS	30 IN CAPE SLEEVE JACKET	SMALL - 3X-LARGE	GOLDEN BROWN
AGLS18	SLEEVES	18 IN	GOLDEN BROWN
AGLS23	SLEEVES	23 IN	GOLDEN BROWN
AGLAS	ANKLE HIGH SPATS		GOLDEN BROWN

Item Number	Description	Sizes	Color
AGLB14	BIB FOR CAPE SLEEVES	14 IN	GOLDEN BROWN
AGLB20	BIB FOR CAPE SLEEVES	20 IN	GOLDEN BROWN
AGLB36	BIB APRON	36 IN	GOLDEN BROWN
AGLB42	BIB APRON	42 IN	GOLDEN BROWN
AGHBP	FR ALUMINIZED BACK HAND SHIELD		GOLDEN BROWN

Armour Guard™ MIG Welding Gloves



AG1350

AG48

AG49

AG50

AGBT88

AG1350 MIG Welding Gloves

Features:

- Premium cowhide leather provides great tensile strength and abrasion resistance
- Wing thumb provides better fitting and grip
- Cowhide leather is naturally insulated when used in high temperatures
- 4" split cuff provides added protection
- DuPont™ Kevlar® stitching provides enhanced strength and protection

Item Number	Description	Size	Pkg Qty
AG1350 (S-XXL)	MIG WELDING GLOVES	SMALL - XX-LARGE	12

AG48 MIG Welding Gloves

Features:

- Premium goatskin palm and split cowhide back
- Engineered to ward off heat. Stays soft under hot conditions
- Fleece lined for extra heat protection without added bulk
- Seamless forefinger and straight thumb provides the best gun grip and reliability
- Thumb strap reinforcement provides additional strength
- 3 1/2" cuff for extra protection. Gripping wrist elastic creates a snug feel
- Sewn with DuPont™ Kevlar® thread for added strength and heat resistance

Item Number	Description	Size	Pkg Qty
AG48 (S-XL)	MIG WELDING GLOVES	SMALL - X-LARGE	12

AG49 MIG Welding Gloves

Features:

- 5" cuff provides added protection
- Reinforced thumb provides protection where it's needed most
- Glide patch provides side protection
- Fleece lined for extra heat protection without added bulk
- Top grain goatskin palm has a natural lanolin content that keeps gloves and hands soft
- Sewn with DuPont™ Kevlar® thread for added strength and heat resistance
- Premium split cowhide leather back is naturally insulated when used in high temperatures
- Thumb strap and patch reinforcement provides added protection
- Seamless forefinger provides the best gun grip and reliability

Item Number	Description	Size	Pkg Qty
AG49 (L-XL)	MIG WELDING GLOVES	LARGE - X-LARGE	12

AG50 MIG Welding Gloves

Features:

- Superior top grain cowhide palm and back
- Engineered to ward off heat. Stays soft under hot conditions. Fleece lined for extra heat protection without added bulk.
- Seamless forefinger that provides reliability
- 4" cuff for extra protection. Gripping wrist elastic creates a snug feel.
- DuPont™ Kevlar® stitching for enhanced strength and protection
- Extra protection added to palm, thumb, and backs of fingers for added resilience
- Winged thumb for a great grip

Item Number	Description	Size	Pkg Qty
AG50 (S-XXL)	MIG WELDING GLOVES	SMALL - XX-LARGE	12

AGBT88 MIG Welding Gloves

Features:

- Premium top grain palm leather glove
- Ideal combination of dexterity and durability
- Lined and padded palm provides comfort, heat protection, and premium feel
- Drag pad offers extra heat protection where it counts
- Rest pad provides wrist comfort and heat protection
- Sewn with DuPont™ Kevlar® thread for added strength and heat resistance

Item Number	Description	Size	Pkg Qty
AGBT88 (S-XL)	MIG WELDING GLOVES	SMALL - X-LARGE	12

(Continued on next page)

Armour Guard™ MIG Welding Gloves

BEST **BEST**



AG1357



AG1611

AG1357 MIG Welding Gloves

Features:

- ANSI A7 Cut Resistant Lining
- Wing thumb provides better fitting and grip
- Sewn with DuPont™ Kevlar® thread for added strength and heat resistance
- 4" cuff provides added protection
- Premium top grain cowhide palm and fingers provides great tensile strength and abrasion resistance

Item Number	Description	Size	Pkg Qty
AG1357 (L-XL)	MIG WELDING GLOVES	LARGE - X-LARGE	12

AG1611 MIG Welding Gloves

Features:

- Premium cowhide leather provides great tensile strength and abrasion resistance
- Split back and cuff provides added protection
- Reinforced palm, thumb and finger provide all round protection
- Drag pad and rest pad provides support and comfort
- DuPont™ Kevlar® stitching provides enhanced strength and protection
- Fully lined for better fitting, comfort and protection

Item Number	Description	Size	Pkg Qty
AG1611 (S-XXL)	MIG WELDING GLOVES	SMALL - XX-LARGE	12

Armour Guard™ STICK Welding Gloves

GOOD



AG1000

AG1000 STICK Welding Gloves

Features:

- Single piece back
- True pearl leather color
- Shoulder split cowhide
- 14" length
- DuPont™ Kevlar® stitching for enhanced strength and protection
- Continuous welted fingers to protect stitching
- Inside cotton lined to provide a comfortable work environment

Item Number	Description	Size	Pkg Qty
AG1000 (L-XL)	STICK WELDING GLOVES	LARGE - X-LARGE	12



Similar to Southern Glove

Item Number	Description	Sizes	Color	Pkg Qty	Case Qty
IGW	SPLIT LEATHER WELDER, COTTON LINED	L	GRAY	12 PR	72 PR

(Continued on next page)

Armour Guard™ STICK Welding Gloves



AG1200 STICK Welding Gloves

- Features:
- 14" length. Single piece & full cotton lined back for extra heat protection and comfort
 - Superior split cowhide stays flexible, even while hot
 - DuPont™ Kevlar® stitching for enhanced strength and protection
 - Continuous welted fingers to protect stitching. Reinforced thumb.
 - Unlined palm to increase dexterity
 - Compare to 1018 Blue Stick Glove

Item Number	Description	Size	Pkg Qty
AG1200 (M-XL)	STICK WELDING GLOVES	MEDIUM - X-LARGE	12

AG1200-18 STICK Welding Gloves

- Features:
- Premium blue side split cowhide leather for tough jobs
 - Wing thumb design
 - Double reinforced thumb. Fully welted for strong hold of stitching
 - 18" length provides maximum hand and forearm coverage
 - DuPont™ Kevlar® stitching for enhanced strength and protection
 - Compare to 1018-18 Blue Stick Glove

Item Number	Description	Size	Pkg Qty
AG1200-18 (M-XL)	STICK WELDING GLOVES	MEDIUM - X-LARGE	12

AG1200T STICK Welding Gloves

- Features:
- Single piece & full cotton lined back for extra heat protection and comfort
 - DuPont™ Kevlar® stitching for enhanced strength and protection
 - Superior split cowhide stays flexible, even while hot
 - Continuous welted fingers to protect stitching. Reinforced thumb
 - 14" length
 - Unlined palm to increase dexterity

Item Number	Description	Size	Pkg Qty
AG1200T (L-XL)	STICK WELDING GLOVES	LARGE - X-LARGE	12

AG1050 STICK Welding Gloves

- Features:
- Cotton lined for extra heat protection and comfort
 - Welted fingers make it more difficult for stitching to come apart
 - Wing thumb provides better fitting and grip
 - 14" Length. Sewn with DuPont™ Kevlar® thread for added strength and heat resistance

Item Number	Description	Size	Pkg Qty
AG1050 (L-XL)	STICK WELDING GLOVES	LARGE - X-LARGE	12

AG1080 STICK Welding Gloves

- Features:
- Blue, Premium side split cowhide
 - 14" Length. Welted fingers make it more difficult for stitching to come apart
 - Reinforced Wing Thumb
 - Cotton/Foam lined back for added heat protection

Item Number	Description	Size	Pkg Qty
AG1080 (L-XL)	STICK WELDING GLOVES	LARGE - X-LARGE	12

	Similar to Southern Glove					
	Item Number	Description	Sizes	Color	Pkg Qty	Case Qty
IBWFL	BLUE LEATHER WELDER, FOAM LINED TO PROVIDE ADDITIONAL COMFORT PADDING. REINFORCED THUMB & PALM, KEVLAR® SEWN	L	BLUE	12 PR	36 PR	

(Continued on next page)

Armour Guard™ STICK Welding Gloves



AG750 STICK Welding Gloves

Features:

- Superior pearl specially-tanned top grain leather stays flexible even when hot
- Premium stiffened leather drag pad that extends glove life and protects the hand's side from high temperatures. Unlined palm to increase dexterity
- 14" length. DuPont™ Kevlar® stitching for enhanced strength and protection
- Additional strength and protection from reinforced thumb. Continuous welted fingers to protect stitching
- Cotton/foam lined back for extra heat protection and comfort
- Epic performance in STICK applications

Item Number	Description	Size	Pkg Qty
AG750 (S-XXL)	STICK WELDING GLOVES	SMALL - XX-LARGE	12

AG850 STICK Welding Gloves

Features:

- Superior gold top cow grain that remains soft even while hot
- Premium stiffened leather drag pad that extends glove life and protects the hand's side from high temperatures. Unlined palm to increase dexterity
- 14" length. DuPont™ Kevlar® stitching for enhanced strength and protection
- Additional strength and protection from reinforced thumb. Continuous welted fingers to protect stitching.
- Cotton/foam lined back for extra heat protection and comfort
- Epic performance in STICK applications

Item Number	Description	Size	Pkg Qty
AG850 (S-XXL)	STICK WELDING GLOVES	SMALL - XX-LARGE	12

AG1150 STICK Welding Gloves

Features:

- Premium Gold/Pearl side split cowhide
- 14" Length
- Durable, insulated with cotton/foam lining
- Double reinforced winged thumb
- Welted fingers make it more difficult for stitching to come apart
- Sewn with DuPont™ Kevlar® thread for added strength and heat resistance

Item Number	Description	Size	Pkg Qty
AG1150 (L-XL)	STICK WELDING GLOVES	LARGE - X-LARGE	12

AG1250 STICK Welding Gloves

Features:

- Blue, Premium side split cowhide
- 14" Length. Welted fingers make it more difficult for stitching to come apart
- Cotton/Foam lined back for added heat protection
- Sewn with DuPont™ Kevlar® thread for added strength and heat resistance

Item Number	Description	Size	Pkg Qty
AG1250 (L-XL)	STICK WELDING GLOVES	LARGE - X-LARGE	12

AG1252 STICK Welding Gloves

Features:

- Superior split cowhide stays flexible, even while hot. 14" length
- ANSI A6 Cut Resistant DuPont Kevlar lining on fingers, palm, and back of glove
- DuPont™ Kevlar® stitching for enhanced strength and protection
- Double reinforced straight thumb provides protection where it's needed most

Item Number	Description	Size	Pkg Qty
AG1252 (L-XL)	STICK WELDING GLOVES	LARGE - X-LARGE	12

AG1270 STICK Welding Gloves

Features:

- Premium red side split cowhide
- 14" Length
- Insulated with cotton/foam lining for added heat protection
- Double reinforced wing thumb
- Welted fingers make it more difficult for stitching to come apart
- Sewn with DuPont™ Kevlar® thread for added strength and heat resistance

Item Number	Description	Size	Pkg Qty
AG1270 (L-XL)	STICK WELDING GLOVES	LARGE - X-LARGE	12

Armour Guard™ TIG Welding Gloves



AG24C TIG Welding Gloves

Features:

- Superior top grain pearl kidskin leather
- DuPont™ Kevlar® stitching for enhanced strength and protection
- Improved grip from the straight thumb
- Unlined to boost the feel and dexterity
- 4" cuff for extra protection of the lower arm
- Ultra pliable

Item Number	Description	Size	Pkg Qty
AG24C (S-XXL)	TIG WELDING GLOVES	SMALL - XX-LARGE	12

AG1328 TIG Welding Gloves

Features: • 4" split cuff provides added protection • Wing thumb provides better fitting and grip • Sewn with DuPont™ Kevlar® thread for added strength and heat resistance

Item Number	Description	Size	Pkg Qty
AG1328 (L-XL)	TIG WELDING GLOVES	LARGE - X-LARGE	12

AG1338 TIG Welding Gloves

Features:

- Premium goat skin leather provides great feel and dexterity
- Reinforced thumb provides protection where it's needed most
- Goat skin has a natural lanolin content that keeps gloves and hands soft
- Straight thumb provides enhanced grip
- 4" split cuff provides added protection
- DuPont™ Kevlar® stitching provides enhanced strength and protection

Item Number	Description	Size	Pkg Qty
AG1338 (S-XXL)	TIG WELDING GLOVES	SMALL - XX-LARGE	12

	Similar to Southern Glove					
	Item Number	Description	Sizes	Color	Pkg Qty	Case Qty
	TIGW4	GOATSKIN TIG WELDER-4 BLUE SPLIT COWHIDE GAUNTLET	L-XL	WHITE	12 PR	120 PR

AG1332 TIG Welding Gloves

Features:

- Premium top grain goatskin construction for the best dexterity
- Reinforced thumb provides protection where it's needed most
- Flexible straight thumb provides the best gun grip and reliability
- ANSI A6 Cut Resistant Palm Lining
- Premium goatskin leather offers ANSI Level 3 Puncture and Abrasion Resistance
- Goat skin has a natural lanolin content that keeps gloves and hands soft

Item Number	Description	Size	Pkg Qty
AG1332 (L-XL)	TIG WELDING GLOVES	LARGE - X-LARGE	12

AG1488 TIG Welding Gloves

Features:

- Premium top grain goatskin palm and back for superior feel and dexterity
- Sewn with Black DuPont Kevlar® thread for added strength and heat resistance
- Ideal dexterity for a TIG welder. Spandex Free
- Stitched with DuPont™ Kevlar® thread for additional strength and heat resistance
- Minimum length elastic cuff provides a snug fit
- Additional focus on the "V" of the thumb enhances the feel of the glove

Item Number	Description	Size	Pkg Qty
AG1488 (S-XL)	TIG WELDING GLOVES	SMALL - X-LARGE	12

AGT50 TIG Welding Gloves

Features:

- Premium goat skin leather provides great feel and dexterity
- Keystone thumb provides comfortable fit
- Drag pad side reinforcement provides support and protection
- Fourchette design provides snug fit and flexibility
- DuPont™ Kevlar® stitching provides enhanced strength and protection
- Goat skin has a natural lanolin content that keeps gloves and hands soft

Item Number	Description	Size	Pkg Qty
AGT50 (S-XXL)	TIG WELDING GLOVES	SMALL - XX-LARGE	12

(Continued on next page)

Armour Guard™ DRIVERS Gloves



AG1414 DRIVERS Gloves

Features:

- Contoured to fit the natural shape of your hand
- DuPont™ Kevlar® stitching for enhanced strength and protection
- Scotch colored cowhide split leather back
- Keystone style thumb design
- Super duty palm made of top grain pearl cowhide
- Unlined to enhance feel and dexterity

Item Number	Description	Size	Pkg Qty
AG1414 (S-XXL)	DRIVERS GLOVES	SMALL - XX-LARGE	12



Similar to Southern Glove						
Item Number	Description	Sizes	Color	Pkg Qty	Case Qty	
AYSBDKTK	LEATHER DRIVER, A+ GRADE COW GRAIN, UNLINED, KEYSTONE THUMB, GOLDEN SHOULDER SPLIT BACK, SHIRRED ELASTIC, ROLLED CUFF, SIZE INDICATING COLOR LABEL SEWN INTO SIDE SEAM, SEWN WITH KEVLAR® THREAD	XS-3XL	NATURAL	12 PR	120 PR	

AG1415 DRIVERS Gloves

Features:

- Premium goat skin leather provides great feel and dexterity
- Abrasion resistant
- Keystone thumb provides comfortable fit
- Elastic back at wrist provides secure fit
- Color coded hem for each size
- Goat skin has a natural lanolin content that keeps gloves and hands soft

Item Number	Description	Size	Pkg Qty
AG1415 (S-XXL)	DRIVERS GLOVES	SMALL - XX-LARGE	12



Similar to Southern Glove						
Item Number	Description	Sizes	Color	Pkg Qty	Case Qty	
GLDK	LEATHER DRIVER, A/B INDUSTRIAL GRADE GOAT GRAIN, UNLINED, KEYSTONE THUMB, SHIRRED ELASTIC, BROWN BINDING	S-2XL	WHITE	12 PR	120 PR	

AG1415A3 DRIVERS Gloves

Features:

- Premium top grain goatskin construction for the best dexterity
- Premium goatskin leather offers ANSI Level 3 Cut Protection and Abrasion Resistance
- DuPont™ Kevlar® stitching for enhanced strength and protection
- Keystone thumb provides comfortable fit
- Color coded hem for each size
- Goat skin has a natural lanolin content that keeps gloves and hands soft
- Elastic back and wrist provides secure fit

Item Number	Description	Size	Pkg Qty
AG1415A3 (M-XL)	DRIVERS GLOVES	MEDIUM - X-LARGE	12



Similar to Southern Glove						
Item Number	Description	Sizes	Color	Pkg Qty	Case Qty	
FPA3LDK	A/B GRADE COWHIDE LEATHER DRIVER, KEYSTONE THUMB, FULL PARA-ARAMID/GLASS LINING WITH ANSI 105 A3 RATING, SHIRRED ELASTIC BACK	L-XL	NATURAL	12 PR	120 PR	

(Continued on next page)

Armour Guard™ DRIVERS Gloves



AG1415A4

AG1420

AG1424

AG1457

AG1464

AG1415A4 DRIVERS Gloves

Features:

- Premium top grain goatskin construction for the best dexterity
- Premium goatskin leather offers ANSI Level 4 Cut Protection and Abrasion Resistance
- DuPont™ Kevlar® stitching for enhanced strength and protection
- Keystone thumb provides comfortable fit
- Goat skin has a natural lanolin content that keeps gloves and hands soft
- Elastic back and wrist provides secure fit. Color coded hem for each size

Item Number	Description	Size	Pkg Qty
AG1415A4 (M-XL)	DRIVERS GLOVES	MEDIUM - X-LARGE	12

AG1420 DRIVERS Gloves

Features:

- Premium pearl top grain cowhide
- Leather rolled cuff
- Gunn cut
- Straight thumb for the best grip
- Unlined
- Added strength derived from double stitching on forefinger

Item Number	Description	Size	Pkg Qty
AG1420 (S-XXL)	DRIVERS GLOVES	SMALL - XX-LARGE	12

	Similar to Southern Glove					
	Item Number	Description	Sizes	Color	Pkg Qty	Case Qty
LDK	LEATHER DRIVER, INDUSTRIAL GRADE COW GRAIN, UNLINED, KEYSTONE THUMB, SHIRRED ELASTIC		S-3XL	NATURAL	12 PR	120 PR

AG1424 DRIVERS Gloves

Features:

- Premium cowhide leather provides great tensile strength and abrasion resistance
- Forefingers are double stitched for extra strength
- Unlined
- Premium rolled leather cuff
- Keystone thumb provides comfortable fit
- Gunn cut

Item Number	Description	Size	Pkg Qty
AG1424 (M-XL)	DRIVERS GLOVES	MEDIUM - X-LARGE	12

	Similar to Southern Glove					
	Item Number	Description	Sizes	Color	Pkg Qty	Case Qty
ALDWTK	LEATHER DRIVER, PREMIUM A+ INDUSTRIAL GRADE COW GRAIN, UNLINED, WING THUMB, SHIRRED ELASTIC, ROLLED CUFF, SEWN WITH KEVLAR® THREAD		XS-3XL	NATURAL	12 PR	120 PR

AG1457 DRIVERS Gloves

Features:

- Premium top grain cowhide leather drivers glove with superior cut resistance
- Dupont™ Kevlar® liner provides ANSI A7 cut resistance
- Leather fingers and palm provide excellent dexterity
- Added strength derived from Kevlar® double stitching on forefinger
- Keystone thumb provides a comfortable fit
- Cinched cuff keeps out dust and debris
- Extra thick premium leather provides ANSI Level 5 puncture resistance
- Premium leather offers ANSI level 4 Abrasion protection

Item Number	Description	Size	Pkg Qty
AG1457 (M-XL)	DRIVERS GLOVES	MEDIUM - X-LARGE	12

AG1464 DRIVERS Gloves

Features:

- Premium top grain cowhide palm with reinforcement in the palm, thumb, and index finger
- Sewn with DuPont™ Kevlar® thread for added strength and heat resistance
- Wing thumb for a natural feel. Elastic in the cowhide split back for a snug fit
- Rolled index finger adds more protection for spot welding

Item Number	Description	Size	Pkg Qty
AG1464 (S-XXL)	DRIVERS GLOVES	SMALL - XX-LARGE	12

(Continued on next page)

Armour Guard™ WORK Gloves



AG1525 WORK Gloves

Features:

- Professional, affordable work glove
- Gunn cut with 2" rubberized safety cuff and canvas backing
- Rugged, side-split cowhide palm and knuckle strap

Item Number	Description	Size	Pkg Qty
AG1525 (S-XXL)	WORK GLOVES	SMALL - XX-LARGE	12

AG1515B WORK Gloves

Features:

- Ideal high-end work glove
- Gunn cut style glove with 2" rubberized safety cuff and a canvas back
- Shoulder split cowhide, double palm, and knuckle strap
- Double palmed for additional palm protection to key areas
- DuPont™ Kevlar® stitching for enhanced strength and protection

Item Number	Description	Size	Pkg Qty
AG1515B (L-XL)	WORK GLOVES	LARGE - X-LARGE	12

Armour Guard™ MECHANICS Gloves



AG1470 MECHANICS Gloves

Features:

- Premium top grain goatskin construction for the best dexterity
- Double palm helps increase the life of the glove
- Reinforced leather thumb protects wear areas better than thinner, single layer leather
- Adjustable TPR cuff allows for minor adjustments to fit
- Spandex back allows sweat to evaporate and provides a better stretch feel
- Fingertips are wrapped in leather and double stitched for extra strength and abrasion resistance
- Goat natural provides abrasion resistance
- Napp (Rough Side) of the leather is on the exterior of the glove to improve grip

Item Number	Description	Size	Pkg Qty
AG1470 (S-XXL)	MECHANICS GLOVES	SMALL - XX-LARGE	12

AG1490 MECHANICS Gloves

Features:

- Premium gold/pearl goat skin leather provides great feel and dexterity
- Double reinforced finger tips provide double the protection
- Padded palm and reinforced thumb provides extra protection
- Side patches provides extra protection
- Spandex back for better fitting and breathable finger design
- Elastic cuff with hook and loop for protection and adjustment of size
- Goat skin has a natural lanolin content that keeps gloves and hands soft

Item Number	Description	Size	Pkg Qty
AG1490 (S-XXL)	MECHANICS GLOVES	SMALL - XX-LARGE	12

Armour Guard™ Anti-Fatigue Mats

Features:

- Closed-cell nitrile blended cushion is permanently molded (not glued) to the nitrile rubber top surface
- Welding safe and electrically conductive
- Recommended for distribution, manufacturing and retail facilities for picking lines, assembly lines, work stations, check-out stations, and more
- Chemical-resistant, grease and oil-resistant; borders will not crack or curl



AGMAT36X60



AGMAT36X60HDYS



AGMATPORT12X22

Item Number	Description	Size
AGMAT36X60	RUBBER FATIGUE MAT	3 FT X 5 FT X 5/8 IN
AGMAT36X60HD	HEAVY DUTY RUBBER FATIGUE MAT	3 FT X 5 FT X 7/8 IN
AGMAT36X60HDYS	HEAVY DUTY RUBBER FATIGUE MAT WITH YELLOW STRIPE	3 FT X 5 FT X 5/8 IN
AGMAT36X60YS	RUBBER FATIGUE MAT WITH YELLOW STRIPE	3 FT X 5 FT X 5/8 IN

Item Number	Description	Size
AGMAT48X72HD	HEAVY DUTY RUBBER FATIGUE MAT	4 FT X 6 FT X 7/8 IN
AGMATPORT12X22	PORTABLE COMFORT MAT	12 IN X 22 IN X 7/8 IN
AGMATPORT18X30	PORTABLE COMFORT MAT	18 IN X 30 IN X 7/8 IN

Armour Guard™ Rolled Goods

Techniweld carries a wide range of Armour Guard™ rolled goods in various sizes and weight. Armour Guard™ is the ultimate combination of performance, durability, and value. These fabrics offer high-temperature and heat resistance, along with the ability to shed welding splatter and molten steel & aluminum splash. Typical applications are as rolled goods, or high-temperature rolled goods for engine exhaust components or industrial equipment, steam and gas turbines. Armour Guard™ rolled goods protect workers and equipment from the hazards of UV flash, spatter, and sparks.

Armour Guard™'s rolled goods protect your equipment and working area while welding. Their fire resistant materials make them an essential complimentary piece to your working equipment.



AGI46050WBA



AGI36050WRA



AGI83650WTC

Uncoated

Item Number	Description	Oz. per Sq. Yd.	Height	Length	Color	Coating
AG184025WTU	FM-APPROVED FABRIC, WELDING GRADE ROLL	18 OZ.	40"	25 YD.	TAN	UNCOATED
AG186025WTU	FM-APPROVED FABRIC, WELDING GRADE ROLL	18 OZ.	60"	25 YD.	TAN	UNCOATED
AG184050WTU	FM-APPROVED FABRIC, WELDING GRADE ROLL	18 OZ.	40"	50 YD.	TAN	UNCOATED
AG186050WTU	FM-APPROVED FABRIC, WELDING GRADE ROLL	18 OZ.	60"	50 YD.	TAN	UNCOATED
AG1860500WTU	FM-APPROVED FABRIC, WELDING GRADE ROLL	18 OZ.	60"	500 YD.	TAN	UNCOATED
AG187225WTU	FM-APPROVED FABRIC, WELDING GRADE ROLL	18 OZ.	72"	25 YD.	TAN	UNCOATED
AG244050WOU	FM-APPROVED FABRIC, WELDING GRADE ROLL	24 OZ.	40"	50 YD.	ORANGE	UNCOATED
AG246050WOU	FM-APPROVED FABRIC, WELDING GRADE ROLL	24 OZ.	60"	50 YD.	ORANGE	UNCOATED
AG246050WTU	FM-APPROVED FABRIC, WELDING GRADE ROLL	24 OZ.	60"	50 YD.	TAN	UNCOATED
AG354050WOU	FM-APPROVED FABRIC, WELDING GRADE ROLL	35 OZ.	60"	50 YD.	ORANGE	UNCOATED

(Continued on next page)

Acrylic Coating

Item Number	Description	Oz. per Sq. Yd.	Height	Length	Color	Coating
AG106050WRA	FIBERGLASS FABRIC, WELDING GRADE ROLL	10 OZ.	60"	50 YD.	RED	ACRYLIC
AG136050WRA	FIBERGLASS FABRIC, WELDING GRADE ROLL	13 OZ.	60"	50 YD.	RED	ACRYLIC
AG146050WBA	FM-APPROVED FABRIC, WELDING GRADE ROLL	14 OZ.	60"	50 YD.	BLACK	ACRYLIC
AG164025WPA	FIBERGLASS FABRIC, WELDING GRADE ROLL	16 OZ.	40"	25 YD.	PINK	ACRYLIC
AG166025WPA	FIBERGLASS FABRIC, WELDING GRADE ROLL	16 OZ.	60"	25 YD.	PINK	ACRYLIC
AG167225WPA	FIBERGLASS FABRIC, WELDING GRADE ROLL	16 OZ.	72"	25 YD.	PINK	ACRYLIC
AG164050WPA	FM-APPROVED FABRIC, WELDING GRADE ROLL	16 OZ.	40"	50 YD.	PINK	ACRYLIC
AG164050WRA	FM-APPROVED FABRIC, WELDING GRADE ROLL	16 OZ.	40"	50 YD.	RED	ACRYLIC
AG166050WPA	FM-APPROVED FABRIC, WELDING GRADE ROLL	16 OZ.	60"	50 YD.	PINK	ACRYLIC
AG166050WRA	FM-APPROVED FABRIC, WELDING GRADE ROLL	16 OZ.	60"	50 YD.	RED	ACRYLIC
AG244050WYA	FM-APPROVED FABRIC, WELDING GRADE ROLL	24 OZ.	40"	50 YD.	YELLOW	ACRYLIC
AG246050WBA	FIBERGLASS FABRIC, WELDING GRADE ROLL	24 OZ.	60"	50 YD.	BLACK	ACRYLIC
AG246050WYA	FIBERGLASS FABRIC, WELDING GRADE ROLL	24 OZ.	60"	50 YD.	YELLOW	ACRYLIC

Silica Fabric

Item Number	Description	Oz. per Sq. Yd.	Height	Length	Color	Coating
AG183650WTC	FM-APPROVED FABRIC, WELDING GRADE ROLL	18 OZ.	36"	50 YD.	TAN	SILICA
AG186050WTC	FM-APPROVED FABRIC, WELDING GRADE ROLL	18 OZ.	60"	50 YD.	TAN	SILICA
AG323650WTC	FIBERGLASS FABRIC, WELDING GRADE ROLL	32 OZ.	36"	50 YD.	TAN	SILICA

Silicone Coating

Item Number	Description	Oz. per Sq. Yd.	Height	Length	Color	Coating
AG156050IGS	FM-APPROVED FABRIC, INSULATION GRADE ROLL	15 OZ.	60"	50 YD.	GRAY	SILICONE
AG156050WGS	FIBERGLASS FABRIC, WELDING GRADE ROLL	15 OZ.	60"	50 YD.	GRAY	SILICONE
AG174850WGS	FIBERGLASS FABRIC, WELDING GRADE ROLL	17 OZ.	48"	50 YD.	GRAY	SILICONE
AG176050WGS	FIBERGLASS FABRIC, WELDING GRADE ROLL	17 OZ.	60"	50 YD.	GRAY	SILICONE
AG176050IGS	FM-APPROVED FABRIC, INSULATION GRADE ROLL	17 OZ.	60"	50 YD.	GRAY	SILICONE
AG176050WRS	FM-APPROVED FABRIC, WELDING GRADE ROLL	17 OZ.	60"	50 YD.	RED	SILICONE
AG323550WRS	FIBERGLASS FABRIC, WELDING GRADE ROLL	32 OZ.	35"	50 YD.	RED	SILICONE
AG326050WGS	FM-APPROVED FABRIC, WELDING GRADE ROLL	32 OZ.	60"	50 YD.	GRAY	SILICONE
AG326050WRS	FM-APPROVED FABRIC, WELDING GRADE ROLL	32 OZ.	60"	50 YD.	RED	SILICONE

Armour Guard™ Welding Blankets

Techniweld carries a full range of Armour Guard™ fiberglass welding blankets in every size and weight. Armour Guard™ is the ultimate combination of performance, durability, and value. These fabrics offer high-temperature and heat resistance, along with the ability to shed welding splatter and molten steel & aluminum splash. Typical applications are as welding screens or blankets, or high-temperature protection blankets for engine exhaust components or industrial equipment, steam and gas turbines.

Armour Guard™'s welding blankets protect your equipment and working area while welding. Their fire resistant materials make these blankets an essential complimentary piece to your working equipment.



AGWB186X6TU



AGWB246X60U

(Continued on next page)

Uncoated

Item Number	Description	Oz. per Sq. Yd.	Length	Width	Color	Coating
AGWB146X8LU	FIRE-RESISTANT FM4950-CERTIFIED WELDING BLANKET	14 OZ.	6 FT.	8 FT.	BLUE/TEAL	UNCOATED
AGWB186X6TU	FIRE-RESISTANT FM4950-CERTIFIED WELDING BLANKET	18 OZ.	6 FT.	6 FT.	TAN	UNCOATED
AGWB186X8TU	FIRE-RESISTANT FM4950-CERTIFIED WELDING BLANKET	18 OZ.	6 FT.	8 FT.	TAN	UNCOATED
AGWB188X8TU	FIRE-RESISTANT FM4950-CERTIFIED WELDING BLANKET	18 OZ.	8 FT.	8 FT.	TAN	UNCOATED
AGWB188X10TU	FIRE-RESISTANT FM4950-CERTIFIED WELDING BLANKET	18 OZ.	8 FT.	10 FT.	TAN	UNCOATED
AGWB1810X10TU	FIRE-RESISTANT FM4950-CERTIFIED WELDING BLANKET	18 OZ.	10 FT.	10 FT.	TAN	UNCOATED
AGWB1812X12TU	FIRE-RESISTANT FM4950-CERTIFIED WELDING BLANKET	18 OZ.	12 FT.	12 FT.	TAN	UNCOATED
AGWB246X6OU	FIRE-RESISTANT FM4950-CERTIFIED WELDING BLANKET	24 OZ.	6 FT.	6 FT.	ORANGE	UNCOATED
AGWB246X8OU	FIRE-RESISTANT FM4950-CERTIFIED WELDING BLANKET	24 OZ.	6 FT.	8 FT.	ORANGE	UNCOATED
AGWB1810X12TU	FIRE-RESISTANT FM4950-CERTIFIED WELDING BLANKET	18 OZ.	10 FT.	12 FT.	TAN	UNCOATED
AGWB246X8WU	FIRE-RESISTANT FM4950-CERTIFIED WELDING BLANKET, 550 °C SERVICE	24 OZ.	6 FT.	8 FT.	WHITE	UNCOATED
AGWB356X6WU	FIRE-RESISTANT FM4950-CERTIFIED WELDING BLANKET, 550 °C SERVICE	35 OZ.	6 FT.	6 FT.	WHITE	UNCOATED
AGWB356X8WU	FIRE-RESISTANT FM4950-CERTIFIED WELDING BLANKET, 550 °C SERVICE	35 OZ.	6 FT.	8 FT.	WHITE	UNCOATED
AGWB3510X10WU	FIRE-RESISTANT FM4950-CERTIFIED WELDING BLANKET, 550 °C SERVICE	35 OZ.	10 FT.	10 FT.	WHITE	UNCOATED

Acrylic Coating

Item Number	Description	Oz. per Sq. Yd.	Length	Width	Color	Coating
AGWB145X10BA	FIRE-RESISTANT FM4950-CERTIFIED WELDING BLANKET	14 OZ.	5 FT.	10 FT.	BLACK	ACRYLIC
AGWB166X6PA	FIRE-RESISTANT FM4950-CERTIFIED WELDING BLANKET	16 OZ.	6 FT.	6 FT.	PINK	ACRYLIC
AGWB166X8PA	FIRE-RESISTANT FM4950-CERTIFIED WELDING BLANKET	16 OZ.	6 FT.	8 FT.	PINK	ACRYLIC
AGWB1410X12BA	FIRE-RESISTANT FM4950-CERTIFIED WELDING BLANKET	14 OZ.	10 FT.	10 FT.	BLACK	ACRYLIC
AGWB1610X10PA	FIRE-RESISTANT FM4950-CERTIFIED WELDING BLANKET	16 OZ.	10 FT.	10 FT.	PINK	ACRYLIC
AGWB246X8YA	FIRE-RESISTANT FM4950-CERTIFIED WELDING BLANKET	24 OZ.	6 FT.	8 FT.	YELLOW	ACRYLIC
AGWB246X6YA	FIRE-RESISTANT FM4950-CERTIFIED WELDING BLANKET, 550 °C SERVICE	24 OZ.	6 FT.	6 FT.	YELLOW	ACRYLIC
AGWB246X10YA	FIRE-RESISTANT FM4950-CERTIFIED WELDING BLANKET, 550 °C SERVICE	24 OZ.	6 FT.	10 FT.	YELLOW	ACRYLIC
AGWB248X8YA	FIRE-RESISTANT FM4950-CERTIFIED WELDING BLANKET, 550 °C SERVICE	24 OZ.	8 FT.	8 FT.	YELLOW	ACRYLIC
AGWB248X10YA	FIRE-RESISTANT FM4950-CERTIFIED WELDING BLANKET, 550 °C SERVICE	24 OZ.	8 FT.	10 FT.	YELLOW	ACRYLIC
AGWB2410X100U	FIRE-RESISTANT FM4950-CERTIFIED WELDING BLANKET, 550 °C SERVICE	24 OZ.	10 FT.	10 FT.	ORANGE	ACRYLIC
AGWB2410X10YA	FIRE-RESISTANT FM4950-CERTIFIED WELDING BLANKET, 550 °C SERVICE	24 OZ.	10 FT.	10 FT.	YELLOW	ACRYLIC
AGWB303X3YA	FIRE-RESISTANT FM4950-CERTIFIED WELDING BLANKET, 550 °C SERVICE	30 OZ.	3 FT.	3 FT.	YELLOW	ACRYLIC
AGWB306X6YA	FIRE-RESISTANT FM4950-CERTIFIED WELDING BLANKET, 550 °C SERVICE	30 OZ.	6 FT.	6 FT.	YELLOW	ACRYLIC
AGWB306X8YA	FIRE-RESISTANT FM4950-CERTIFIED WELDING BLANKET, 550 °C SERVICE	30 OZ.	6 FT.	8 FT.	YELLOW	ACRYLIC
AGWB308X8YA	FIRE-RESISTANT FM4950-CERTIFIED WELDING BLANKET, 550 °C SERVICE	30 OZ.	8 FT.	8 FT.	YELLOW	ACRYLIC
AGWB308X10YA	FIRE-RESISTANT FM4950-CERTIFIED WELDING BLANKET, 550 °C SERVICE	30 OZ.	8 FT.	10 FT.	YELLOW	ACRYLIC
AGWB3010X10YA	FIRE-RESISTANT FM4950-CERTIFIED WELDING BLANKET, 550 °C SERVICE	30 OZ.	10 FT.	10 FT.	YELLOW	ACRYLIC
AGWB3012X12YA	FIRE-RESISTANT FM4950-CERTIFIED WELDING BLANKET, 550 °C SERVICE	30 OZ.	12 FT.	12 FT.	YELLOW	ACRYLIC

Silicone Coating

Item Number	Description	Oz. per Sq. Yd.	Length	Width	Color	Coating
AGWB156X8GS	FIRE-RESISTANT FM4950-CERTIFIED WELDING BLANKET	15 OZ.	6 FT.	8 FT.	GRAY	SILICONE
AGWB1710X12RS	FIRE-RESISTANT FM4950-CERTIFIED WELDING BLANKET	17 OZ.	10 FT.	12 FT.	RED	SILICONE
AGWB328X8GS	FIRE-RESISTANT FM4950-CERTIFIED WELDING BLANKET	32 OZ.	8 FT.	8 FT.	GRAY	SILICONE

Vermiculite Impregnated

Item Number	Description	Oz. per Sq. Yd.	Length	Width	Color	Coating
AGWB253X3BV	FIRE-RESISTANT FM4950-CERTIFIED WELDING BLANKET, 750 °C SERVICE	25 OZ.	3 FT.	3 FT.	BLACK	VERMICULITE
AGWB256X6BV	FIRE-RESISTANT FM4950-CERTIFIED WELDING BLANKET, 750 °C SERVICE	25 OZ.	6 FT.	6 FT.	BLACK	VERMICULITE
AGWB256X8BV	FIRE-RESISTANT FM4950-CERTIFIED WELDING BLANKET, 750 °C SERVICE	25 OZ.	6 FT.	8 FT.	BLACK	VERMICULITE
AGWB258X8BV	FIRE-RESISTANT FM4950-CERTIFIED WELDING BLANKET, 750 °C SERVICE	25 OZ.	8 FT.	8 FT.	BLACK	VERMICULITE
AGWB258X10BV	FIRE-RESISTANT FM4950-CERTIFIED WELDING BLANKET, 750 °C SERVICE	25 OZ.	8 FT.	10 FT.	BLACK	VERMICULITE
AGWB2510X10BV	FIRE-RESISTANT FM4950-CERTIFIED WELDING BLANKET, 750 °C SERVICE	25 OZ.	10 FT.	10 FT.	BLACK	VERMICULITE

(Continued on next page)

Silica Fabric

Item Number	Description	Oz. per Sq. Yd.	Length	Width	Color	Coating
AGWB183X3TC	FIRE-RESISTANT FM4950-CERTIFIED WELDING BLANKET, 900 °C SERVICE	18 OZ.	3 FT.	3 FT.	TAN	SILICA
AGWB186X6TC	FIRE-RESISTANT FM4950-CERTIFIED WELDING BLANKET, 900 °C SERVICE	18 OZ.	6 FT.	6 FT.	TAN	SILICA
AGWB186X8TC	FIRE-RESISTANT FM4950-CERTIFIED WELDING BLANKET, 900 °C SERVICE	18 OZ.	6 FT.	8 FT.	TAN	SILICA
AGWB189X10TC	FIRE-RESISTANT FM4950-CERTIFIED WELDING BLANKET, 900 °C SERVICE	18 OZ.	9 FT.	10 FT.	TAN	SILICA
AGWB1810X10TC	FIRE-RESISTANT FM4950-CERTIFIED WELDING BLANKET, 900 °C SERVICE	18 OZ.	10 FT.	10 FT.	TAN	SILICA
AGWB1825X25TC	FIRE-RESISTANT FM4950-CERTIFIED WELDING BLANKET, 900 °C SERVICE	18 OZ.	25 FT.	25 FT.	TAN	SILICA
AGWB363X3TC	FIRE-RESISTANT FM4950-CERTIFIED WELDING BLANKET, 900 °C SERVICE	30 OZ.	3 FT.	3 FT.	TAN	SILICA
AGWB366X6TC	FIRE-RESISTANT FM4950-CERTIFIED WELDING BLANKET, 900 °C SERVICE	30 OZ.	6 FT.	6 FT.	TAN	SILICA
AGWB366X8TC	FIRE-RESISTANT FM4950-CERTIFIED WELDING BLANKET, 900 °C SERVICE	30 OZ.	6 FT.	8 FT.	TAN	SILICA
AGWB369X10TC	FIRE-RESISTANT FM4950-CERTIFIED WELDING BLANKET, 900 °C SERVICE	30 OZ.	9 FT.	10 FT.	TAN	SILICA

Armour Guard™ Welding Screens

Armour Guard™ by Techniweld USA offers high quality vinyl welding screens. Paired with our Armour Guard™ frame, these screens provide reliable protection at any job site offering safety, spark containment, durability, portability, temperature, and noise control. Flame retardant transparent vinyl provides optical protection when visibility is required. Formulated to disperse arc image and allow light back into work area. Armour Guard™ frames are easy to assemble and are made to be modular & extendable to make long screens walls; each metal frame is fitted with a special attachment on the sides, as standard, which enables another metal frame to be connected/extended using a special small part called the frame extender.

Welding Screen Features:

- Armour Guard™ Welding Screens protect workers and equipment from the hazards of UV flash, spatter, and sparks
- Armour Guard™ welding Screens are grommeted along edges
- Armour Guard™ made Welding Screens are made from 14 mil (0.35mm) PCV film, and treated with special additives for UV stability and fire-resistance
- Easy connection allows assembly without tools

Welding Frame Features: • Each section slides in for locking • No tools required for assembly • Pipe joints have screwless push fit snap locks • Made of 1" (25mm) round tube

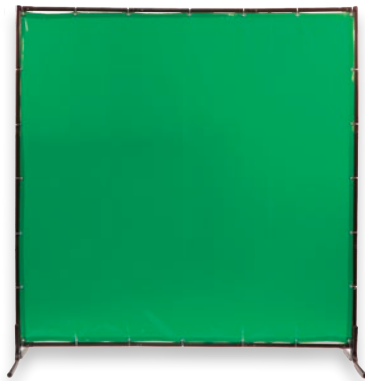

TWWC6X6GRN

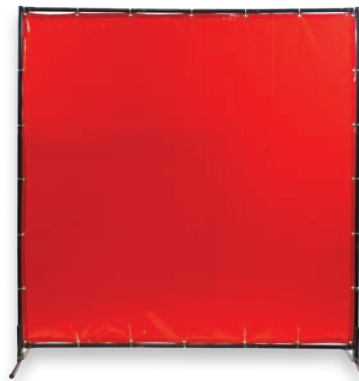

TWWC6X6ORG

Item Number	Description	Size
TWWC6X6GRN	GREEN TANSAPRENT VINYL WELDING SCREEN	6 FT X 6 FT
TWWC6X6GRNWF	GREEN TANSAPRENT VINYL WELDING SCREEN WITH FRAME	6 FT X 6 FT
TWWC6X6ORG	ORANGE TANSAPRENT VINYL WELDING SCREEN	6 FT X 6 FT
TWWC6X6ORGWF	ORANGE TANSAPRENT VINYL WELDING SCREEN WITH FRAME	6 FT X 6 FT
TWWC6X8GRN	GREEN TANSAPRENT VINYL WELDING SCREEN	6 FT X 8 FT
TWWC6X8GRNWF	GREEN TANSAPRENT VINYL WELDING SCREEN WITH FRAME	6 FT X 8 FT

Item Number	Description	Size
TWWC6X8ORG	ORANGE TANSAPRENT VINYL WELDING SCREEN	6 FT X 8 FT
TWWC6X8ORGWF	ORANGE TANSAPRENT VINYL WELDING SCREEN WITH FRAME	6 FT X 8 FT
TWWCF6X6	WELDING TANSAPRENT VINYL SCREEN FRAME	6 FT X 6 FT
TWWCF6X8	WELDING TANSAPRENT VINYL SCREEN FRAME	6 FT X 8 FT
TWWCF6XEX	18 GAUGE EXPANDABLE WELDING SCREEN FRAME	6 FT X 6 OR 8 FT

Armour Guard™ Safety Debris Nettings

Features:

- Made of high density polyethylene (HDPE), machine knitted with reinforced hems
- Flame Retardant netting complies with NFPA 701 requirements
- Offers the heaviest weight for debris netting of 100 grams per square meter, while still maintaining the highest 6% FR chemical by weight ratio in the industry
- Small 1/4" Openings catches most serious falling debris
- Ideal for multi-story construction and maintenance sites
- Helps catch objects from falling and injuring someone below
- UV treated to maintain effectiveness in sunlight

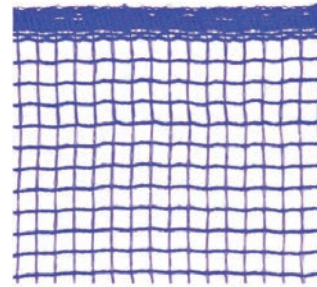
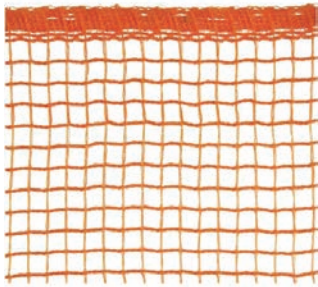

Item Number	Dimensions	Color	Pkg Qty
AGDN4X150ORGFR	4' X 150'	ORANGE	50 ROLLS/PALLET

Item Number	Dimensions	Color	Pkg Qty
AGDN4X150BLUFR	4' X 150'	BLUE	50 ROLLS/PALLET

Armour Guard™ Safety Dividers

ARMOUR GUARD™ SAFETY SCREEN CLEAR (SCREEN ONLY)

For use with the TWWCF6X8 or TWWCF6X6 frame.

Features:

- Barrier protection from airborne contamination from each other
- Lightweight & modular
- Clean easily - with most spray cleaners or water
- No tools required for assembly
- Grommeted along all edges



Item Number	Dimensions	Color
AGC4X8CLR	4' X 8'	CLEAR
AGC6X6CLR	6' X 6'	CLEAR

ARMOUR GUARD™ HANGING CLEAR SAFETY DIVIDER SCREEN

Contains 7/8" diameter pipe, curtain with eyelets weighted at the bottom and hanging rings (chain, line, rope not included).

Features:

- Barrier protection from airborne contamination from each other
- Lightweight & modular
- Easy to assemble - basic hardware included (No tools required)
- Clean easily - with most spray cleaners or water
- Embedded metal chain at bottom of screen is to provide weight to the screen from swaying in a normal room air draft



Item Number	Dimensions	Color
AGC5436H	54" X 36"	CLEAR
AGC7252H	72" X 52"	CLEAR



TECHNIWELDUSA

ARMOUR GUARD

CLAIRVOYANT

2" x 4.25" MULTI SHADE Auto-Darkening Filter Lens

Step aside red, blue, and #1, the king is back!

See past the glare with Techniweld's new Armour Guard Clairvoyant lens.

The competition is... cute. We are full on **heavy-duty**. With a **stainless-steel body**, the Clairvoyant lens reflects infrared radiation which **keeps the lens cooler**, thus allowing for welding at higher amperages.

You may be thinking "so what?" Us too; so we added the **best-in-class tig capabilities down to 3 amps**. Love to pulse? No problem.

Still not sold? We added a **full range 5-13 shades in a digital platform**. No old-school analog tech here. Who's got the time for that?

We then sat back and said, "That's better, but how do we make it so epic that people fall out of their chairs?"

So we added a **3-year warranty**, gave the lens **replaceable batteries**, made the clear state 3, added a grind button AND added full sensitivity and delay settings like an expensive welding helmet. I'm almost out of breath saying all that!



I know you're thinking, "Shut up, I'll take one already!", but the people paying me to write this want you to have the full story. So...we priced the lens to give the end-users the **highest quality "22nd" century technology at an affordable price**.

Now Available! Order Today!

Armour Guard™ Clairvoyant Patent Pending with USPTO. Meets ANSI Z87.1 Specifications.



Orders of 10 units are in Pop-Up Display Box Patent Pending

TECH SPECS

- Cartridge size: 4.25" x 2" x 0.197"
- Viewing area: 3.8" x 1.38"
- Power: Solar and Lithium battery
- Shade: Clear at Shade 3
 - Dark at Shade 5 for cutting
 - Darkest at Shades 8-13 for welding
- Grind: Yes
- Sensitivity: 7 levels
- Delay time: 7 levels ranging from 0.06-1 second
- Switch time between shades: 0.06ms.
- Optical quality: 1/1/1/2 according to EN379
- TIG capability: > 3A



BLUE STAR

FOR ALL YOUR ELECTRIC WELDING ACCESSORIES AND SMAW (STICK) WELDING NEEDS

Techniweld USA's, *Blue Star™*, provides an aid to welders from all different types of welding environments in all Oxy-fuel gas cutting and controlling needs. The oxy-fuel gas cutting process cuts metal by using the chemical combination of oxygen with metal at high temperatures. The necessary amount of temperature is created by combining a fuelled gas and oxygen. The cutting action is produced through a pure oxygen stream.

The benefits of using Oxy-fuel Cutting Process:

- When compared to mechanical means, steel can generally be cut faster.
- The oxy-fuel equipment is easy to carry, lowers cost, safe to use, and can be used for a variety of purposes.
- Both thin and thick plates can be cut fast with manual systems.
- Preparing the plate edge for bevel operations oxy-fuel is an economical method.
- Able to cut through rusty and crooked plates easily
- You don't have to be an expert in order to produce acceptable results.

However, oxy-fuel has limitations:

- When compared to other cutting processes, the cutting dimensional limits are not as precise.
- Only cutting carbon and cast steels
- You must be careful when oxy-fuel cutting in order to minimize hazardous results.
- In order to cut special alloys, you may need to take the additional step of heating the metal before and/or both to complete the cutting process.



Safety Guidelines	40
Outfits & Handles	41-44
Torches	44-45
Welding & Heating Tips	46
Cutting Tips	47-48
Strikers & Flints	49
Weed Burners	50
Regulators & Flow Meters	51-55
Pressure Gauges	55-57
Balloon Fillers	57
Hoses, Reel & Repair Kits	58-59
Brass fittings	60-64
Cylinder Carts	65
Gas Cylinder Hook	66
Tote	66
Track Torch & Track	67

Safety Guidelines

Your safety is the most important! When going through the oxy-fuel cutting process make sure to:

- Always wear the proper safety apparel, which includes but not limited to goggles, gloves, and clothing.
- Always check the proper regulator for the amount of gas in the cylinder.
- Always check the cylinder valves and close or replace caps when finished using cylinders.
- Always have a fire extinguisher handy, as well as performing a Safety risk assessment before welding.
- Never use cylinders that have been stored in temperatures over 125°F (52°C).
- Make sure cylinders are stored in the upright position.
- Please remove all lighters, matches, or flammable products from pockets or near the welding and cutting area.
- Check to make sure welding hoses do not touch the flame or sparks when cutting.
- Always be aware of your surroundings when using a cutting torch.

Range of Hand Cutting Operating							
Plate Thickness (inches)	Cutting Speed (inches per minute)	Oxygen Preheat (psig)	Oxygen Cut Flow (cfh)	Oxygen Pressure (psig)	Fuel Flow (cfh)	Fuel Pressure (psig)	Cut Kerf (inches)
1/8	20-30	5-6	20-25	20-25	6-11	3-5	0.04
1/4	20-28	5-7	30-35	20-25	6-11	3-5	0.05
3/8	18-26	8-10	55-60	25-30	6-11	3-5	0.06
1/2	16-22	8-10	60-65	30-35	8-13	3-7	0.06
3/4	15-20	10-12	80-85	30-35	9-16	3-7	0.07
1	13-18	12-15	140-160	35-40	10-18	3-7	0.09
2	10-12	14-18	210-240	40-45	14-25	4-8	0.11
3	10-12	16-20	280-320	40-45	18-28	5-11	0.12
4	6-9	20-30	390-450	45-55	20-30	6-13	0.15
6+	4-6	25-35	500-600	30-40	22-30	8-14	0.15

Cutting Range	
	Light Duty
	Heavy Duty
	Straight Cutting Torch

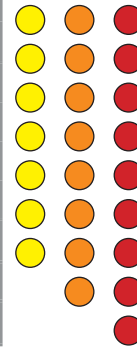

Range of Machine Cutting Operating								
Tip Size	Plate Thickness (inches)	Cutting Speed (inches per minute)	Oxygen Preheat (psig)	Oxygen Cut Flow (cfh)	Oxygen Pressure (psig)	Fuel Flow (cfh)	Fuel Pressure (psig)	Cut Kerf (inches)
00	3/8	22-29	25-45	68-75	85-95	6-11	5-10	0.05
0	1/2	20-28	45-65	110-120	85-95	8-13	5-10	0.06
0	3/4	18-26	45-75	110-120	85-95	9-16	5-10	0.06
1	1	1-24	75-100	145-160	85-95	10-18	5-10	0.07
2	2	11-15	90-110	230-250	85-95	14-25	7-12	0.09
2	3	9-11	90-110	230-250	85-95	18-28	7-12	0.09
3	4	7-10	100-120	285-320	85-95	22-35	7-12	0.11
3	6+	4-7	100-120	285-320	85-95	25-65	10-15	0.11
4	8+	4-6	110-130	390-450	85-95	25-65	10-15	0.14
5	10+	3-5	120-140	670-720	85-95	25-65	10-15	0.18

Torch Outfits

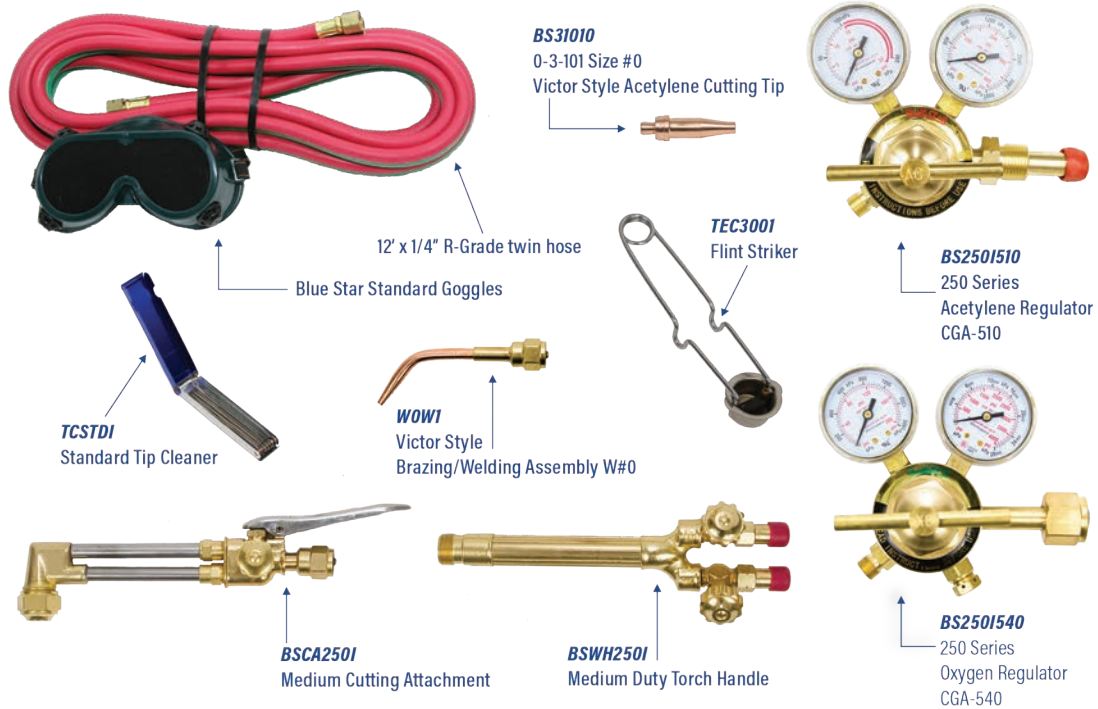

250 Series Light Duty Torch Outfits

The Blue Star™ 250 series outfits provide light duty welding and cutting performance in home and trade environments.

Item Number
BS250TO

- Cut up to 5"
- Weld up to 1.25" with proper tips
- WH250 Handle
- CA250 cutting attachment
- 250 series Oxygen and CGA 510 Acetylene regulator
- 0-3-101 cutting tip
- Victor® Style #0 Welding Nozzle (0-W-1)
- 12' x 1/4" R-Grade twin hose
- Flint Striker
- Goggles and Tip Cleaner Set

Item Number
BS250TO300

- Cut up to 5"
- Weld up to 1.25" with proper tips
- WH250 Handle
- CA250 cutting attachment
- 250 series Oxygen and CGA 300 Acetylene regulator
- 0-3-101 cutting tip
- Victor® Style #0 Welding Nozzle (0-W-1)
- 12' x 1/4" R-Grade twin hose
- Flint Striker
- Goggles and Tip Cleaner Set

All regulators, welding handles, and cutting attachments are  LISTED

Torch Outfits

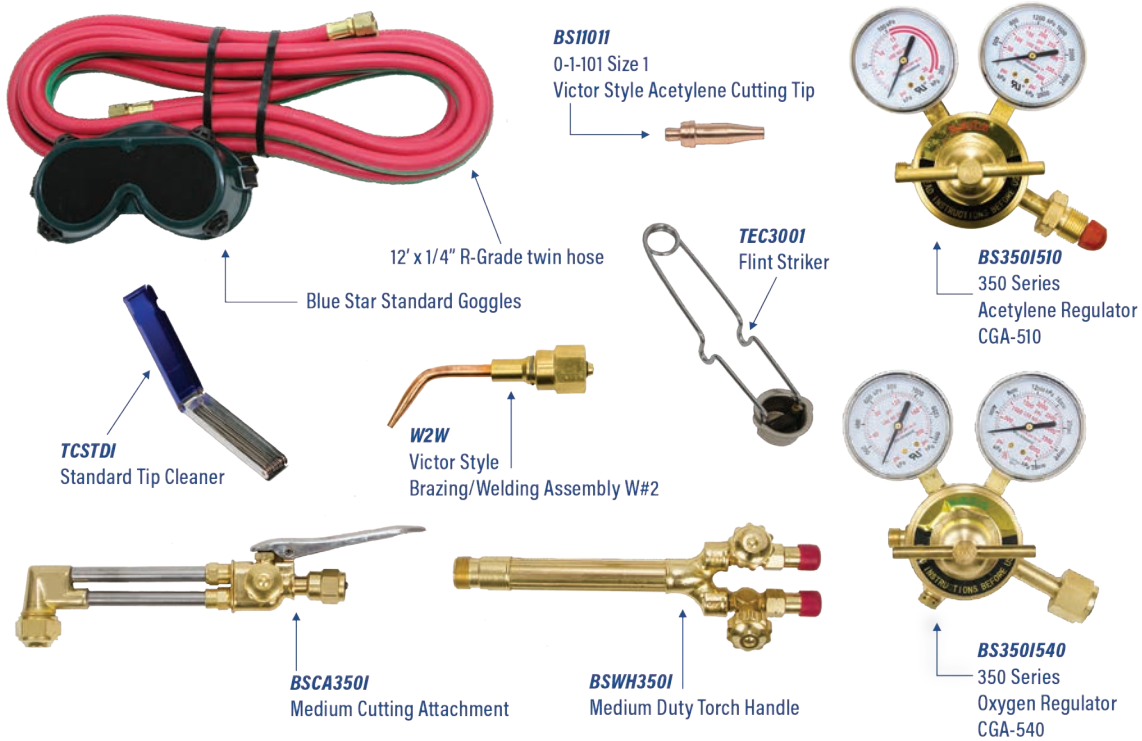

350 Series Heavy Duty Torch Outfits

The Blue Star™ 350 series outfits provide heavy duty welding and cutting performance in industrial, construction, farm, and M&R environments.

Item Number
BS350TO

- Cut up to 8"
- Weld up to 3" with proper tips
- WH350 Handle
- CA350 cutting attachment
- 350 series Oxygen and CGA 510 Acetylene regulator
- 1-1-101 cutting tip
- Victor® Style #2 Welding Nozzle (2-W)
- 12' x 1/4" R-Grade twin hose
- Flint Striker
- Goggles and Tip Cleaner Set

Item Number
BS350TO300

- Cut up to 8"
- Weld up to 3" with proper tips
- WH350 Handle
- CA350 cutting attachment
- 350 series Oxygen and CGA 300 Acetylene regulator
- 1-1-101 cutting tip
- Victor® Style #2 Welding Nozzle (2-W)
- 12' x 1/4" R-Grade twin hose
- Flint Striker
- Goggles and Tip Cleaner Set

All regulators, welding handles, and cutting attachments are LISTED

Torch Outfits

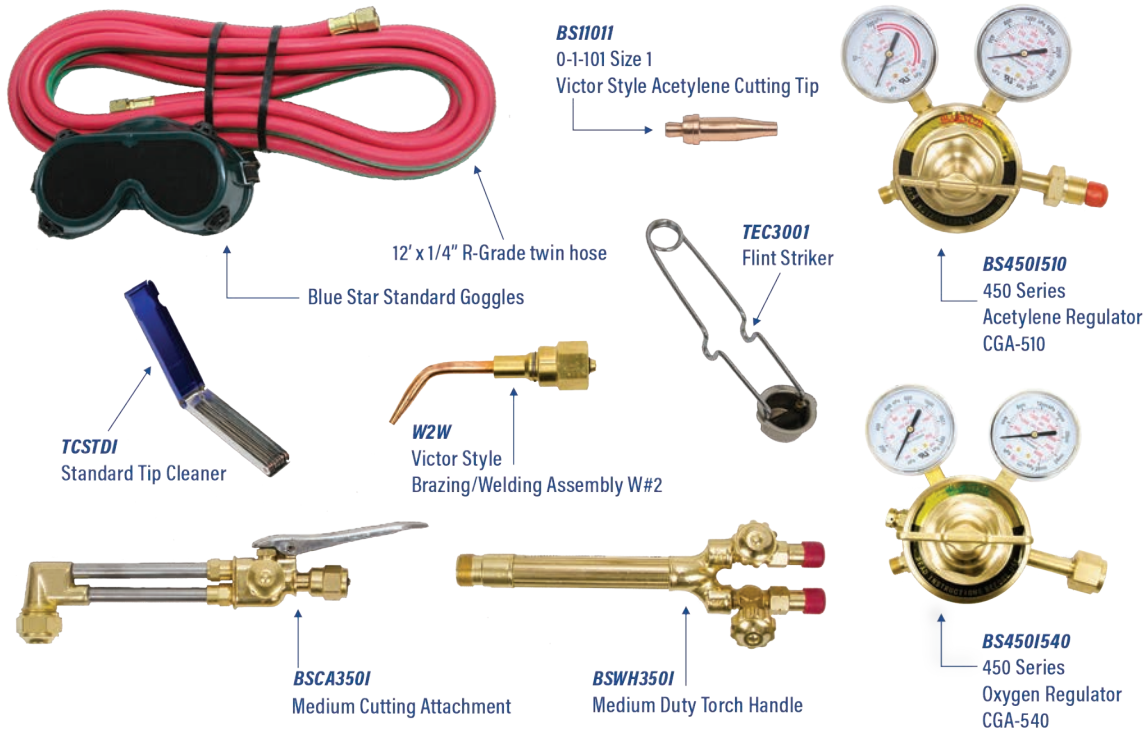

450 Series Heavy Duty Torch Outfits

The Blue Star™ 450 series outfits provide heavy duty welding and cutting performance in industrial, construction, and oilfield environments.

Item Number
BS450TO (540/510)
BS450TO300 (540/300)

- Cut up to 8"
- Weld up to 3" with proper tips
- WH350 Handle
- CA350 cutting attachment
- 450 series Oxygen and CGA 540 Acetylene regulator
- 1-1-101 cutting tip
- Victor® Style #2 Welding Nozzle (2-W)
- 12' x 1/4" R-Grade twin hose
- Flint Striker
- Goggles and Tip Cleaner Set

All regulators, welding handles, and cutting attachments are LISTED

(Continued on next page)

Travel Tote Torch Outfits & Kit



The Blue Star™ Travel Tote Kit provides an economical lightweight, highly portable travel tote equipped with a Torch Outfit for welding, brazing, and cutting in light duty maintenance, HVAC, and DIY applications.

All regulators, welding handles, and cutting attachments are  LISTED

- Cut up to 5"
- CA250 cutting attachment
- Victor® Style #2 Welding Nozzle (2-W-1)
- The included portable travel tote is lightweight, economical, and holds one "MC tank as well as one "R" tank (tanks not included)
- Weld up to 1.25" with proper tips
- 150 series back mount Oxygen and Acetylene regulators.
- 12' x 1/4" R-Grade twin hose
- Flint Striker
- WH250 Handle
- 1-3-101 cutting tip
- Goggles and Tip Cleaner Set

Item Number
BSPTK (Travel Tote and Torch Outfit)
BS1020 (Travel Tote Only)
BSTOTETO (Torch Outfit Only)
BSCUTTERTO (Heavy-Duty Cutting Outfit With 21" Cutting Torch & 450 Regulators)



Cutting Torches

Victor® Style Heavy-Duty Hand Cutting Torch

- 9/16" - 18 connections
- 90° UI head
- Built-in check valves
- Cuts from 1/8" to 10"
- Uses Series 1 Victor® Style cutting tips
- 21", 36", and 48" overall length models
- Universal mixers work with all equal pressure fuel gases 3 PSI and higher.



Item Number	Length	Description
BS1400V	21"	Medium - Heavy Duty
BS1400V36 / *BS1400V36FB	36"	Medium - Heavy Duty
BS1400V48 / *BS1400V48FB	48"	Medium - Heavy Duty

*With Built-In Flash Back Arrestors

(Continued on next page)

Cutting Torches

Victor® Style Cutting Attachment & Torch Handle

- Flame tested in USA for superior performance
- American quality control
- Contain copper threading and are made from complete solid bar stock where applicable
- Solid, not hollow, heavy duty gas apparatus accessories to increase life, heat dissipation, and overall performance
- UL Listed
- Parts are Victor® compatible

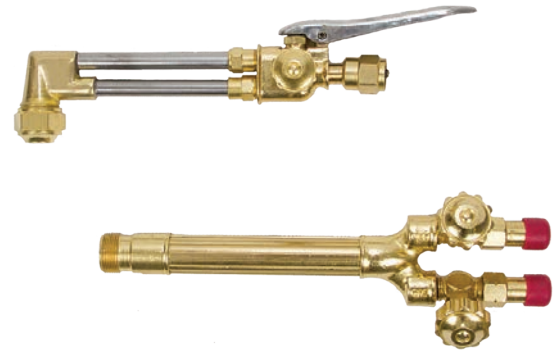

Item Number	Description
BSCA250I (Cutting Attachment)	Light - Medium Duty
BSWH250I (Torch Handle)	Light - Medium Duty
BSCA350I (Cutting Attachment)	Medium - Heavy Duty
BSWH350I (Torch Handle)	Medium - Heavy Duty

Cutting Attachment Seat Kits	Item Number	Description
	BSCA250SK	Seat Kit For BSCA250
	BSCA350SK	Seat Kit For BSCA350

Cutting Attachment O-Rings	Item Number	Description
	BS250ORINGS	O-Rings For BSCA250
	BS350ORINGS	O-Rings For BSCA350

Harris® Style Heavy-Duty Hand Cutting Torch







- 9/16" - 18 "B" connections
- Available with 90° or 75° heads
- Use Harris® Style 6290 cutting tips
- Cuts up to 12" with proper tips
- Available in "E" Series with equal pressure mixer for use with fuel gases at 3 PSI and above, or "F" Series* injectors for use with fuel gases and N.G. at 4 oz. pressure and up.
- Includes reverse flow check valves



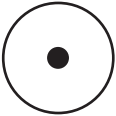





Item Number	Length	Head Angle	Description	Fuel/Gases
BS623E2190	21"	90°	Heavy Duty	Acetylene & other at 3PSI and higher
BS623F2190	21"	90°	Heavy Duty	Natural Gas & alternate at 4 oz. and higher*
BS623E3690	36"	90°	Heavy Duty	Acetylene & other at 3PSI and higher
BS623F3675	36"	75°	Heavy Duty	Natural Gas & alternate at 4 oz. and higher*
BS623E4890	48"	90°	Heavy Duty	Acetylene & other at 3PSI and higher
BS623E4875	48"	75°	Heavy Duty	Acetylene & other at 3PSI and higher
BS623F4890	48"	90°	Heavy Duty	Natural Gas & alternate at 4 oz. and higher*
BS623F4875	48"	75°	Heavy Duty	Natural Gas & alternate at 4 oz. and higher*
BS623F6090	60"	90°	Heavy Duty	Acetylene & other at 3PSI and higher
BS623F60180	60"	180°	Heavy Duty	Acetylene & other at 3PSI and higher
BS623EINJ	60"	180°	Heavy Duty	Acetylene & other at 3PSI and higher
BS623FINJ	60"	180°	Heavy Duty	Natural Gas & alternate at 4 oz. and higher*

*NOT FOR USE WITH ACETYLENE

Welding and Heating Tips











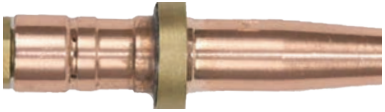

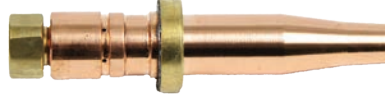

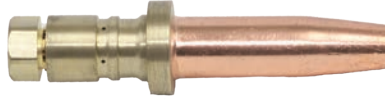





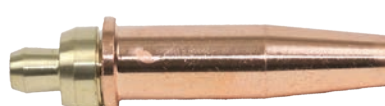

Item	End	Item Number	Style	Torch Style	Tip	Sizes
		W00W1, W0W1, W1W1, W2W1, W3W1, W4W1, W5W1, W6W1	Victor®	100	Welding	00, 0, 1, 2, 3, 4, 5, 6
		W00WJ, W0WJ, W1WJ, W2WJ, W3WJ W4WJ	Victor®	100	Welding	00, 0, 1, 2, 3, 4,
		W00W, W0W, W1W, W2W, W3W, W4W, W5W, W6W, W7W, W8W	Victor®	J	Welding	00, 0, 1, 2, 3, 4, 5, 6, 7, 8
		H8MFN, H10MFN, H12MFN, H15MFN	Victor®	300	Heating	8, 10, 12, 15
		H4MFA, H6MFA, H8MFA, H10MFA, H12MFA, H15MFA	Victor®	300	Heating	4, 6, 8, 10, 12, 15
		H2MFA1, H4MFA1, H6MFA1, H8MFA1	Victor®	100	Heating	2, 4, 6, 8
		H4MFAJ, H6MFAJ	Victor®	J	Heating	4, 6

Cutting Tips

Item	End	Item Number	Style	Cutting	Preheat	Sizes
		BS1380, BS1382	Airco®	General	Medium	0, 2
		BS14400, BS1440, BS1441, BS1442, BS1443, BS1444, BS1445, BS1446	Airco®	General	Medium	00, 0, 1, 2, 3, 4, 5, 6
		BS16400, BS1640, BS1641, BS1642, BS1643, BS1644, BS1645, BS1646, BS1647	Airco®	General	Medium	00, 0, 1, 2, 3, 4, 5, 6, 7
		BS2610, BS2611, BS2612, BS2613, BS2614, BS2615, BS2618, BS2632, BS2633	Airco®	General	Medium	0, 1, 2, 3, 4, 5, 6, 8
		BS2750, BS2751, BS2752 BS2753, BS2754, BS2755	Airco®	General	Medium	0, 1, 2, 3, 4, 5,
		BS629000, BS62900, BS62901, BS62902, BS62903, BS62904, BS62905, BS62906	Harris®	Hand	Medium	00, 0, 1, 2, 3, 4, 5, 6
		BS6290NFF0, BS6290NFF1 BS6290NFF2, BS6290NFF3, BS6290NFF4, BS6290NFF5, BS6290NFF6	Harris®	General	Medium	1, 2, 3, 4, 5, 6
		BS6290NX000, BS6290NX00, BS6290NX0, BS6290NX1, BS6290NX2, BS6290NX3, BS6290NX4, BS6290NX5, BS6290NX6	Harris®	General	Medium	000, 00, 0, 1, 2, 3, 4, 5, 6
		BS6290GG1, BS6290GG2, BS6290GG3, BS6290GG4	Harris®	Gouging	Medium	1, 2, 3, 4
		BS15022, BS15023, BS15024, BS15026	Oxweld®	Hand	Medium	2, 3, 4, 6
		BS42021, BS42022, BS42023, BS42024, BS42025, BS42026, BS42027, BS42029, BS42031, BS42032, BS42033, BS42034, BS42035	Purox®	Hand	Medium	2, 3, 4, 5, 7, 9

(Continued on next page)

Cutting Tips

Item	End	Item Number	Style	Cutting	Preheat	Sizes
		BSMC1200, BSMC120, BSMC121, BSMC122, BSMC123, BSMC124, BSMC125	Smith®	General	Medium	00, 0, 1, 2, 3, 4, 5
		BSSC12000, BSSC1200, BSSC120, BSSC121, BSSC122, BSSC123, BSSC124, BSSC125, BSSC126	Smith®	Hand	Medium	000, 00, 0, 1, 2, 3, 4, 5, 6
		BSSC5000, BSSC500, BSSC501, BSSC502, BSSC503, BSSC504, BSSC505, BSSC506	Smith®	Hand	Heavy	00, 0, 1, 2, 3, 4, 5, 6
		BS1101000, BS110100, BS11010, BS11011, BS11012, BS11013, BS11014, BS11015, BS11016, BS11017, BS11018	Victor®	Hand	Medium	000, 00, 0, 1, 2, 3, 4, 5, 6, 7, 8
		BS3101000, BS310100, BS31010, BS31011, BS31012, BS31013, BS31014, BS31015	Victor®	Hand	Medium	000, 00, 0, 1, 2, 3, 4, 5
		BS11180, BS11182, BS11184, BS11186, BS11188, BS31182	Victor®	Gouging	Medium	0, 2, 4, 6, 8
		BSGPM0, BSGPM1, BSGPM2, BSGPM3, BSGPM4	Victor®	Hand	Heavy	0, 1, 2, 3, 4
		BSGPN000, BSGPN00, BSGPN0, BSGPN1, BSGPN2, BSGPN3, BSGPN4, BSGPN5, BSGPN6, BSGPN7, BSGPN8	Victor®	Hand	Heavy	000, 00, 0, 1, 2, 3, 4, 5, 6, 7, 8
		BS3GPN000, BS3GPN00, BS3GPN0, BS3GPN1, BS3GPN2, BS3GPN3, BS3GPN4, BS3GPN5	Victor®	Hand	Medium	000, 00, 0, 1, 2, 3, 4, 5
		BSGPP000, BSGPP00, BSGPP0, BSGPP1, BSGPP2, BSGPP3, BSGPP4, BSGPP5, BSGPP6	Victor®	Hand	Medium	000, 00, 0, 1, 2, 3, 4, 5, 6
		BS11080, BS11081, BS11082, BS11083, BS11084	Victor®	Hand	Medium	0, 1, 2, 3, 4

Strikers and Flints

Blue Star™ offers a variety of strikers and flints for your oxy-fuel welding needs.

Single Flint Striker



Item Number
TEC3001
TECTR1960

Single Flint Replacements



Item Number
TEC3001X
TECTR1965

Triple Flint Striker



Item Number
TEC4501

Triple Flint Replacements



Item Number
TEC5003X

Spark Lighter

Premium range spark lighter by Blue Star™

Upgrade from your traditional flint lighter to our more efficient money-saving option

- Electric multi-spark discharge will accurately ignite all fuel gases quickly and easily
- Made of high quality materials; zinc plated body resists rust and corrosion
- Energy generator used never needs flint, batteries, or a charge
- Minimum of five sparks per squeeze
- Can withstand severe working conditions
- Ignites Oxy/LPG and Oxy/Acetylene only
- Extended Life

Item Number
SLPIEZO



Tip Cleaner

Stainless steel wire files for cleaning the gas orifices of cutting and welding tips. File sizes from 49 to 77. Tip file comes in an aluminum case.

Cleaner Size 6-26

Drill Size 49-77

Item Number	Description
TCSTDI	Standard Tip Cleaner

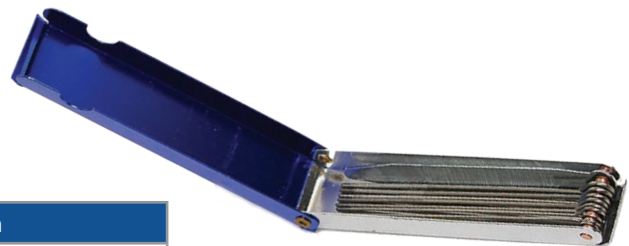

Weed Burners

Blue Star™ Fireboss weed burner kit

- 500,000 BTU Output which connects to standard 20-Pound barbecue grill type liquid propane tank
- Features a brass control knob that will not lock or freeze during use, an all steel torch handle and torch head construction
- 10-Feet (304 m) hose with POL safety valve and universal CGA-510 LP connection
- Striker included for proper ignition and 36-Inch all steel handle and torch head
- Practical uses include burning weeds, melting ice, repairing asphalt
- UL Listed
- Parts are Victor® Compatible



Item Number

FIREBOSS

Blue Star™ 10' Replacement Hose For Fireboss Weed Burner

- 10-Feet (304 m) hose with POL safety valve and universal CGA-510 LP connection
- UL Listed
- Parts are Victor® Compatible



Item Number

FIREBOSSHOSE

150 Series Pressure Regulators

The Blue Star™ 150 series pressure regulators provide a back mount, and are designed for use with travel tote portable style torch outfits. Light-duty performance for maintenance, HVAC, and DIY applications.

- Single-stage design
- Home and trade use
- Forged brass body and housing cap
- 1.5" gauges
- Stem type seat mechanism
- Sintered inlet filter
- Built-in relief valve (oxygen, inert)
- Maximum inlet: 3000psig
- Fabric reinforced neoprene diaphragm
- Dimensions: 4.5"W x 4.5"H x 4.75"D



Item Number	Description	Outlet Pressure (psig)	Inlet Fitting	Gas Service (CGA)	Tank Size
BS150I200	150 Series Acetylene 200 Pressure Regulator	2-15	200	Acetylene	MC
BS150I520	150 Series Acetylene 520 Pressure Regulator	2-15	520	Acetylene	B
BS150I540	150 Series Oxygen 540 Pressure Regulator	5-80	540	Oxygen	R

250 Series Pressure Regulators



The Blue Star™ 250 series pressure regulators provide a Light-duty performance.

- Single-stage design
- Home and trade use
- Forged brass body and housing cap
- 2" gauges
- Stem type seat mechanism
- Sintered inlet filter
- Built-in relief valve (oxygen, inert)
- Maximum inlet: 3000psig
- Fabric reinforced neoprene diaphragm
- Dimensions: 6.5"W x 5.25"H x 4.5"D

Item Number	Description	Outlet Pressure (psig)	Inlet Fitting	Gas Service (CGA)
BS250I300	250 Series Acetylene 300 Pressure Regulator	2-15	300	Acetylene
BS250I510	250 Series Acetylene 510 Pressure Regulator	2-15	510	Acetylene
BS250I540	250 Series Oxygen 540 Pressure Regulator	5-125	540	Oxygen

(Continued on next page)

350 Series Pressure Regulators



The Blue Star™ 350 series pressure regulators provide heavy-duty welding and cutting performance in industrial, construction, farm, and M&R environments.

- Single-stage design
- Forged brass body and housing cap
- 2.5" gauges
- Stem type seat mechanism
- Sintered inlet filter
- Built-in relief valve (Oxygen and Nitrogen models only)
- Maximum inlet: 3000psig
- Fabric reinforced neoprene diaphragm
- Dimensions: 7.5"W x 6"H x 5"D

Item Number	Description	Outlet Pressure (psig)	Inlet Fitting	Gas Service (CGA)
BS3501300	350 Series Acetylene 300 Pressure Regulator	2-15	300	Acetylene
BS3501580	350 Series Inert 580 Pressure Regulator	5-125	580	Inert
BS3501LPG	350 Series Alternate Fuel 510 Pressure Regulator	2-40	510	Alternate Fuel
BS3501510	350 Series Acetylene 510 Pressure Regulator	2-15	510	Acetylene
BS3501540	350 Series Oxygen 540 Pressure Regulator	5-125	540	Oxygen

450 Series Pressure Regulators

The Blue Star™ 450 series pressure regulators provide heavy-duty welding and cutting performance in industrial, construction, and oilfield environments.

- Extra heavy duty single-stage design
- Forged brass body and housing cap
- 2.5" gauges
- Stem type seat mechanism
- Sintered inlet filter
- Built-in relief valve (oxygen regulators only)
- Maximum inlet: 3000psig
- Stainless Steel diaphragms for consistent performance in extreme weather conditions.
- Dimensions: 7.5"W x 6"H x 5"D



Item Number	Description	Outlet Pressure (psig)	Inlet Fitting	Gas Service (CGA)
BS4501510	450 Series Acetylene 510 Pressure Regulator	2-15	510	Acetylene
BS4501540	450 Series Oxygen 540 Pressure Regulator	5-125	540	Oxygen
BS4501580	450 Series Inert 580 Regulator	5-125	580	Inert

(Continued on next page)

Argon/CO2 Flowmeter Regulators



BS 1480 Series



BS85AR580DF



BS 85 Series

The Blue Star™ Argon/CO₂ Flowmeter Regulators provide heavy duty performance for optimum controlled gas flow results. They are produced with a Teflon seat which filters out any contamination from entering. Also, our Teflon seat reduces CO₂ freeze-up.

1480 Series Flowmeter Regulators

- Piston type design
- Preset pressure set to 25 psig for accurate flow control
- Brass housing
- 50 CFH models
- Built-in relief valve
- Maximum inlet: 3000 psig
- 5/8" - 18 RH(F) outlet fitting
- Teflon seat
- Argon, CO₂, and Argon mixed models

85 Series Flowmeter Regulators

- Diaphragm type design
- Preset pressure set to 25 psig for accurate flow control
- Brass housing
- 50 and 70 CFH models
- Built-in relief valve
- Maximum inlet: 3000 psig
- 5/8" - 18 RH(F) outlet fitting
- Teflon seat
- Argon, CO₂, and Argon mixed models

Item Number	Description	Outlet Pressure (psig)	Max Flow (CFH)	Inlet Fitting	Gas Service (CGA)
BS1480AR	1480 Series Flowmeter Regulator	25	50	580	Argon/CO ₂
BS1480ARWH	1480 Series Flowmeter Regulator With 6' Hose	25	50	580	Argon/CO ₂
BS1480CD	1480 Series Flowmeter Regulator	25	50	320	CO ₂
BS85AR580	85 Series Flowmeter Regulator	25	50	580	Argon/CO ₂
BS85AR580DF	85 Series Dual Flowmeter Regulator	25	50	580	Argon/CO ₂
BS85CD320	85 Series Flowmeter Regulator	25	70	320	CO ₂

(Continued on next page)

Argon/CO₂ Flow Gauge Regulators

**BSFGMR****BS250I320**

The Blue Star™ Argon/CO₂ Flow Gauge Regulators provide light-medium duty performance for optimum controlled gas flow results.

- Argon "MIG Meter"
- Brass bonnets and bodies
- Argon and CO₂ models
- 0.020" orifice
- 2" Gauges

Item Number	Description	Max Flow	Inlet Fitting	Gas Service (CGA)
BSFGMR	Argon 580 Flow Gauge Regulator	50 SCFH	580	Argon
BS250I320	CO ₂ 320 Flow Gauge Regulator	50 CFH	320	CO ₂



Replacement Parts

Diaphragm



Item Number	Description	Gas Service (CGA)
BS250DIA	Diaphragm for 250 series Acetylene/Oxygen Regulator	Oxy/Acet
BS250ACDIA	Diaphragm for 250 series Acetylene Regulator	Acetylene
BS350ACDIA	Diaphragm for 350 series Acetylene Regulator	Acetylene
BS350OXDIA	Diaphragm for 350 series Oxygen Regulator	Oxygen
BS450DIA	Diaphragm for 450 series Acetylene/Oxygen Regulator	Oxy/Acet

Seat



Item Number	Description	Gas Service (CGA)
BS250ACSEAT	Seat for the Diaphragm for 250 series Acetylene Regulator	Acetylene
BS250OXSEAT	Seat for the Diaphragm for 250 series Oxygen Regulator	Oxygen
BS350ACSEAT	Seat for the Diaphragm for 350 series Acetylene Regulator	Acetylene
BS350OXSEAT	Seat for the Diaphragm for 350 series Oxygen Regulator	Oxygen
BS450ACSEAT	Seat for the Diaphragm for 450 series Acetylene Regulator	Acetylene
BS450OXSEAT	Seat for the Diaphragm for 450 series Oxygen Regulator	Oxygen

Adjustment Screw Key



Item Number	Description	Gas Service (CGA)
BS250ACKEY	Adjustment Screw Key for 250 series Acetylene Regulator	Acetylene
BS250OXKEY	Adjustment Screw Key for 250 series Oxygen Regulator	Oxygen
BS350ACKEY	Adjustment Screw Key for 350 series Acetylene Regulator	Acetylene
BS350OXKEY	Adjustment Screw Key for 350 series Oxygen Regulator	Oxygen
BS450KEY	Adjustment Screw Key for 450 series Acetylene/Oxygen Regulator	Oxy/Acet
BS450OXKEY	Adjustment Screw Key for 450 series Oxygen Regulator	Oxygen
BSMEDKEY	Adjustment Screw Key for 250 & 350 series Acetylene/Oxygen Regulator	Oxy/Acet

Replacement Pressure Gauges

The Blue Star™ Replacement Pressure Gauges provide safe and efficient oxygen service, and performs for use on oxygen service, medical equipment, and other fuel gases which do not corrode brass or bronze. Designed for use with compressed gas regulators and where stem mounting is needed.

- Brass Case* or Painted Steel
- Lexan Crystals
- Safety Blow Out Backs
- Precision Movement
- 1/4" NPT (National Pipe Thread)
- High Visibility

Obstacles when working with pressure:

*Oxygen Fuel Process should be set to all manufacturer setting recommendations in order for the job to be performed.
Excessive pressure may lead to harsh flame; equipment damage; increased flashback probability.
Lack of pressure may lead to lack of heat; inability to keep a stable flame; increased welding cutting tip probability.*

Replacement Pressure Gauges



2-1/2"



2"

Low Pressure Gauges

**B is Brass Case*

Item Number	Psig
BS25X0030	30
*BS25X0030B	30
BS25X0060	60
*BS25X0060B	60
BS25X0100	100
*BS25X0100B	100
BS25X0200	200
*BS25X0200B	200
BS25X0400	400
*BS25X0400B	400
*BS25X0600B	600

Item Number	Psig
BS2X0030	30
*BS2X0030B	30
BS2X060	60
*BS2X060B	60
BS2X0100	100
*BS2X0100B	100
BS2X0200	200
*BS2X0200B	200
BS2X0300	300
*BS2X0300B	300
BS2X0400	400
*BS2X0400B	400

High Pressure Gauges

M is Bottom Mount Steel Case MB is Brass Case

Item Number	Psig
BS25X1MB	1000
BS25X4M	4000
BS25X4MB	4000

Item Number	Psig
BS2X1MB	1000
BS2X3M	3000
BS2X4M	4000
BS2X4MB	4000

Replacement Gauge Cover

Item Number
BS25CP

Item Number
BS2CP

Balloon Fillers



Economy Balloon Filler Valve

- Piston type mechanism
- Rugged brass body

Item Number
BS229



Economy Balloon Filler with Contents Gauge

- Piston type mechanism
- Rugged brass body
- 1-1/2" rear entry cylinder contents gauge

Item Number
BS229G



Balloon Filler with Contents Gauge

- Piston type mechanism
- Rugged brass body
- Plastic hand-tight CGA 580 inlet connection with sintered bronze inlet filter
- 1-1/2" rear entry cylinder contents gauge

Item Number
BS230HG



Mylar and Latex Balloon Filler with Contents Gauge

- Piston type mechanism
- Rugged brass body
- Drilled and tapped for tie hook and ribbon cutter
- Automatic shut-off mylar filler to prevent over filling and bursting of expensive mylar balloons
- Plastic hand-tight CGA 580 inlet connection with sintered bronze inlet filter
- 1-1/2" rear entry cylinder contents gauge

Item Number
BSHGMYA



1/4 NPTM Tilt Valve For Balloon Regulators

Item Number
BSRB232

Premium Reinforced Welding Hose

With cover made of EDPM + NR Compound

Fittings: USA BB Type - 9/16"-18"

Premium Welding Hose Specifications			
Size	ID (mm)	OD (mm)	Working Pressure (psi)
3/16"	5	11	200
1/4"	6	13	
3/8"	9.5	16.5	
1/4" - 5/16"	6	13	
	8	15	
1/4" - 3/8"	6	16	
	9	16	
5/16" - 3/8"	8	16	
	9	16	

Grade R Single Line Hose Reels			
Item Number	Description	PSI Rating	Braid
HSI2XRLG	1/2" X 800' GREEN	250	Braid
HSI14XRLG	1/4" X 800' GREEN		
HSI14XRLR	1/4" X 800' RED		
HSI14XRLRT	1/4" X 800' RED		
HSI316XRLG	3/16" X 600' GREEN		
HSI316XRLR	3/16" X 600' RED		
HSI34XRL	3/4" X 600' GREEN		
HSI38XRL	3/8" X 600' GREEN		
HSI58XRL	5/8" X 600' GREEN		



Argon Hose With Connections			
Item Number	Description	PSI Rating	Connection Type
HSIARGON6G	1/4" X 6' GREEN	250	Male Argon
HSIARGON12G	1/4" X 12' GREEN		
HSIARGON25G	1/4" X 25' GREEN		
HSIARGON50G	1/4" X 50' GREEN		
HSIARGON100G	1/4" X 100' GREEN		



Premium Welding Hose Reel

Item Number: BSHDHOSEREEL

- Long-lasting, chip-resistant, and rust-inhibiting CPC powder coat finish
- CNC robotically spun and ribbed discs with rolled edges provide strength, safety, and durability
- External fluid path with 90 degree full-flow dual ported brass swivel, offering both connections from the same side of the reel
- Compact, solid, single piece of heavy gauge steel in a "U" shaped frame with open drum design
- Adjustable tension brake to prevent "free-wheeling" during operation, transport, or storage
- Lightweight, compact, and versatile hand crank hose reel
- Side walls are 26% thicker than leading competitor!



(Continued on next page)

Premium Twin Welding Hose



Grade R Fitted Twin Hose			
Item Number	Description	PSI Rating	Connection Type
HTI1316X12	3/16" X 12.5'	250	B-B
HTI1316X25	3/16" X 25'		
HTI1316X50	3/16" X 50'		
HTI1316X100	3/16" X 100'		
HTI14X25	1/4" X 25'		
HTI14X50	1/4" X 50'		
HTI14X100	1/4" X 100'		
HTI316X100	3/16" X 100'		



Grade T Fitted Twin Hose			
Item Number	Description	PSI Rating	Connection Type
HTI14X25T	1/4" X 25'	250	B-B
HTI14X50T	1/4" X 50'		
HTI14X100T	1/4" X 100'		
HTI38X25T	3/8" X 25'		
HTI38X50T	3/8" X 50'		
HTI38X100T	3/8" X 100'		
HTI1316X12T	3/16" X 12.5'		
HTI1316X25T	3/16" X 25'		
HTI1316X50T	3/16" X 50'		
HTI1316X100T	3/16" X 100'		



Grade R and T Twin Hose Reels			
Item Number	Description	PSI Rating	Braid
HTI14XRL	1/4" X 600' GRADE R	250	1
HTI14XRLT	1/4" X 600' GRADE T		
HTI316XRL	3/16" X 600' GRADE T		
HTI316XRLT	3/16" X 600' GRADE T		
HTI38XRLT	1/4" X 600' GRADE T		

Hose Repair Kits & Tools

Item Number	Description
BSCK1	Hose Repair Kit 3/16", 1/4" A & B with C-1 Crimper
BSCK5	Hose Repair Kit 3/16", 1/4" A & B with C-5 Crimper
BSCK20	Hose Repair Kit 3/16" & 1/4" "B" Fittings with C-1 Crimper
BSCK22	Hose Repair Kit 3/16" & 1/4" "B" Fittings with C-3 Crimper
BSCK24	Hose Repair Kit 1/4", "B" Fittings with C-1 Crimper
BSCK26	Hose Repair Kit 1/4", "B" Fittings with C-5 Crimper
BSCK30	Hose Repair Kit 1/4", Argon Hose (NO CRIMPER)
Item Number	Description
BSC5	C-5 Crimping Tool



Brass Fittings

Flashback Arrestors - Oxygen/Fuel Gas

- Fits all "B" size 9/16"-18 fittings (regulators, torches & hoses)
- Built-in check valve prevents reverse gas flow
- Stainless steel sintered element stops multiple flashbacks (no resetting required)
- U/L listed and 100% tested
- 2 PSI minimum pressure for gas flow



Item Number	Description
BSFA10	Oxygen/Fuel Gas Set, Torch Style
BSFA30	Oxygen/Fuel Gas Set, Regulator Style
BS1400VFBS	Replacement flash back arrestors for BS1400V36FB and BS1400V48FB

Quick Connects for Gas Welding Equipment

- Durable brass construction provides for long service life
- Designed for "B" size 9/16"-18" fittings (regulators, torches & hoses)
- Design guided by ISO 7289 safety standards
- Non-interchangeable oxygen/fuel gas connectors to prevent cross connections
- Built-in check valves shut down upstream gases when disconnected



Item Number	Description
BSQDB10	Oxygen/Fuel Gas Quick Connect Set, Torch to Hose Style
BSQDB30	Oxygen/Fuel Gas Quick Connect Set, Regulator to Hose Style

Cylinder Adapters

- Adapters connect a regulator to a cylinder or other equipment when different CGA threads on the mating parts make a direct connection impossible.
- All brass, brazed construction



Item Number	Adapts from Cylinder Service	To Regulator Service
BS61	CGA-300 Commercial Acetylene	CGA-510 POL Acetylene
BS315	CGA-510 POL Acetylene	CGA-520 "B" Tank Acetylene
BS317	CGA-520 "B" Tank Acetylene	CGA-510 POL Acetylene

Hose Nuts

- For pressures up to 200 PSIG
- "A" & "B" Size
- Oxygen & Fuel Gas
- Material: Brass



Item Number	Description	Thread Size	Gas Service	Qty Per Bag
BS7 / BS7-2PK	Oxygen, RH, "B" Size	9/16"-18 RH	CGA-022	25
BS8 / BS8-2PK	Fuel Gas, LH, "B" Size	9/16"-18 LH	CGA-023	25
BS9	Oxygen, RH, "B" Size	3/8"-24 RH-INT	CGA-023	25
BS10	Fuel Gas, RH, "B" Size	3/8"-24 RH-INT	CGA-023	25
BSD7	Oxygen, RH, "D" Size	1 1/4"-12 RH-INT	CGA-023	25

(Continued on next page)

Brass Fittings

Barbed Hose Nipples

- For pressures up to 200 PSIG
- "A" & "B" Size
- For 1/4" or 3/16" Hose
- Oxygen & Fuel Gas
- Material: Brass



Item Number	Size	Length	For Hose Size	Qty Per Bag
BS17 / BS17-2PK	B-Size	1 7/16	1/4" I.D.	25
BS18 / BS18-2PK	B-Size	1 7/16	3/16" I.D.	25
BSD18	D-Size	1/2	3/4" I.D.	25
BSD18	D-Size	1/2	3/4" I.D.	25
BS19 / BS19-2PK	A-Size	1 7/32	3/16" I.D.	25
BS20 / BS20-2PK	B-Size	1 7/16	3/8" I.D.	25

Hose Couplers

- Pressure up to 200 PSIG
- B Size, Oxygen & Fuel Gas
- Material: Brass



Item Number	Description	Inlet Thread Size	Outlet Thread Size	Qty Per Bag
BS30 / BS30-2PK	Oxygen Hose Coupler, B Size	9/16-18 RH	9/16-18 RH	25
BS31 / BS31-2PK	Fuel Gas Hose Coupler, B Size	9/16-18 LH	9/16-18 LH	25

Regulator Outlet Bushings

- Pressure up to 200 PSIG
- B Size, Oxygen & Fuel Gas
- Material: Brass



Item Number	Description	Inlet Thread Size	Outlet Thread Size	Qty Per Bag
BS32 / BS32-2PK	Oxygen Regulator Outlet Adapter	1/4 Male NPT	9/16-18 RH	25
BS33 / BS33-2PK	Fuel Gas Regulator Outlet Adapter	1/4 Male NPT	9/16-18 LH	25
BSB67	C-33 Bushing	1/2 Male NPT	N/A	25

Hose Splicers

- Pressures up to 200 PSIG
- Hexagon, round, spiral or no center stop
- Material: Brass



Item Number	Description	Style	Qty Per Bag
BS44 / BS44-2PK	1/4 to 1/4 I.D. Hose	Barb Round	25
BS45 / BS45-2PK	3/16 to 3/16 I.D. Hose	Barb Round	25
BS47 / BS47-2PK	3/8 to 3/8 I.D. Hose	Barb Round	25
BS53	1/8 to 1/8 I.D. Hose	No Center Stop	25

Brass Fittings

Hose Barb Adapters

- Pressures up to 200 PSIG
- NPT x Hose Barb
- Material: Brass



Item Number	Description	Inlet Thread	Hose Size
BS541	Hose Barb Male NPT Thread	1/4 Male NPT	1/4 I.D.

Inert Arc Nuts (TIG)

- Pressures up to 200 PSIG
- Use with all B size inert arc nipples
- Material: Brass



Item Number	Description	Thread Size	Gas Service	Qty Per Bag
BSAW14 / BSAW14-2PK	Water, Male LH	B Size - 5/8-18	CGA-033	25
BSAW14A / BSAW14A-2PK	Inert Gas, Male RH	B Size - 5/8-18	CGA-032	25

Inert Arc Nipples (TIG)

- Pressures up to 200 PSIG
- Use with all B size inert arc nuts
- Material: Brass



Item Number	Description	Size	Hose Size	Qty Per Bag
BSAW17 / BSAW17-2PK	Inert Arc Nipple, 2- 7/32 Long	B Size, 5/8-18	1/4 I.D.	25
BSAW20	Inert Arc Nipple	B Size, 5/8-18	3/8 I.D.	25

Inert Arc Hose Coupler

- Pressures up to 200 PSIG
- Female x Female
- Material: Brass



Item Number	Description
BSAW430	5/8-18 RH Female to 5/8-18 RH Female
BSAW431	5/8-18 RH Female to 5/8-18 RH Female (10/BX)

"Y" Connectors with Shut-Off Valves

- Pressures up to 200 PSIG
- For use with two cutting or welding hoses at once
- High precision shut-off valves
- Swivel Nut Inlet
- Material: Brass



Item Number	Inlet	Outlet	Gas Service
BS111	Oxygen 9/16-18 RH Female, Swivel Nut	9/16-18 RH Male	CGA-022
BS112	Fuel Gas, 9/16-18 LH Female, Swivel Nut	9/16-18 LH Male	CGA-023
BS411	Argon, 5/8-18 RH Male Swivel Nut	5/8-18 RH Female	CGA-032

(Continued on next page)

Brass Fittings

Brass Shut-Off Valves & Check Valves

- Precision shut-off valves
- Oxygen, fuel gas and non-corrosive gases
- Material: Brass and Chrome Plated Brass



Item Number	Inlet	Outlet	Gas Service	Pressure Rating
BSM24-5CV	1/4" NPT MALE	9/16" NPT MALE	Inert	200 PSIG
BSM24-4CV	1/8" NPT MALE	9/16" NPT MALE	Inert	50 PSIG

Hose Ferrules

- Pressures up to 200 PSIG
- Material: Brass



To determine proper ferrule size, measure OD of the hose (as a decimal) and go up to the next larger size ferrule ID on the chart below.

Item Number	Inside Diameter	Length	Qty Per Bag
BS625	0.525	0.500 In	25
BS626	0.548	0.478 In	25
BS769	0.450	0.562 In	25
BS3588 / BS3588-2PK	0.562	0.750 In	25
BS4750 / BS4750-2PK	0.475	0.688 In	25
BS7322	0.500	1.000 In	25
BS7323 / BS7323-2PK	0.525	1.000 In	25
BS7325 / BS7325-2PK	0.562	1.000 In	25
BS7326 / BS7326-2PK	0.593	1.000 In	25
BS7327	0.625	1.000 In	25
BS7329	0.687	1.000 In	25
BS7331	0.749	1.000 In	25
BSKK	0.575	0.484 In	25

Dual Hose Brace

- Pressures up to 200 PSIG
- Oval shaped design
- Material: Brass



Item Number	Dimensions	Length	Metal Gauge	Qty per Bag
BS9940P	.535 x 1.071 In	.750 In	.024 In	25

(Continued on next page)

Brass Fittings

Brass Manifold Block For Inert Gases

- Flame tested in USA for superior performance
- American quality control
- Contain copper threading and are made from complete solid bar stock where applicable
- Solid, not hollow, heavy-duty gas apparatus accessories to increase life, heat dissipation, and overall performance



Item Number	Swivel Connection	End Connection	CGA
BSMB70	.960-14 NGP-RH-Male	.960-14 NGP-RH Female (6)	580

Brass Manifold Pipe Nipple With Threaded End

- Cleaned For Oxygen Service
- Suitable For Acetylene
- Machined From CDA 360 Brass



Item Number	Working Pressure	Length	Thread Size
BSWHF-3-19	3000 PSI	6"	1/2"-14 NPT

CGA Nuts & Nipples

BLUE Star™ has a wide range of various brass Nuts & Nipples.



Item Number	Part	CGA	Description	Pressure Rating
BS62	Nut	540	Brass, .908-14 NGO, RH Female	3000 PSIG
BS63	Nipple	540	Brass Nipple - Threaded Inlet (NP-210)	3000 PSIG
BS66SF	Nipple	540	Brass, 1/4 NPT, 2-1/2" Long with Filter	3000 PSIG
BS92	Nut	580	Brass, .960"-14 NGO, RH Female	3000 PSIG
BS93	Nut	580	Brass, .960"-14 NGO, RH Male	3000 PSIG
BS15-3	Nipple	500/510/580/590	Brass 1/4" NPT, 3" Long	3000 PSIG
BS153SF	Nipple	500/510/580/590	Brass, 1/4" NPT, 3" Long with Filter	3000 PSIG
BS152	Nut	510	Brass, .880-14 NGO, LH Male	3000 PSIG
BS162	Nut	510	Brass, 16-2 NUT (N56)	3000 PSIG
BSCO2	Nut	320	Brass, .830-14 NGO, RH Female	3000 PSIG
BSCO3	Nipple	320	Brass 1/4" NPT, 2" Long	3000 PSIG
BSCO5 BSCO5-2PK	Washer	320	Fibre®, Flat Washer (50/BAG)	3000 PSIG
BSCO6	Washer	320	Teflon, Flat Washer (25/BAG)	3000 PSIG
BSCO6N	Washer	320	Teflon, Flat Washer (100/BAG)	3000 PSIG
TNA	Tip Nut	320	Airco® Style Tip Nut	3000 PSIG
TNH	Tip Nut	320	Harris® Style Tip Nut	3000 PSIG
TNV	Tip Nut	320	Victor® Style Tip Nut - Large	3000 PSIG
TNVS	Tip Nut	320	Victor® Style Tip Nut - Small	3000 PSIG

Cylinder Carts

- Knock down format reduces shipping costs
- Easy to assemble
- Powder coated green finish
- Used for the easy and safe transportation of heavy gas bottles around
- Welded steel supports



10" W x 9" D Base Plate

Item Number
BSCYT8CH1

- Single Cylinder Cart
- Handle height is approximately 44"
- Two solid rubber wheels with metal rims (8" diameter)



21" W x 11" D Base Plate

Item Number
BSCYT12CHF

- Medium Double Cylinder Cart
- Handle height is approximately 42"
- Two solid rubber wheels with metal rims (12" diameter)



25" W x 13" D Base Plate

Item Number	Description
BSCYT14CHF	Medium Double Cylinder Cart
TOOLBOX	Tool Box for BSCYT14CHF
WSH350	3.0 X 50mm Washer

- Handle height is approximately 44"
- Two solid rubber wheels with metal rims (14" diameter)



15 3/4" W x 8" D BSCYT6SH Base Plate

19 1/2" W x 8" D BSCYT6SH Base Plate

Item Number
BSCYT6SH

- Double Cylinder Cart
- Handle height is approximately 41"
- Two solid rubber wheels with metal rims (6" diameter)



23" W x 13" D Base Plate

Item Number
BSCYT16FLTWD

- Cylinder Cart with 118" Firewall and Lifting Eye
- Large, open tool tray
- Dual cylinder brackets
- Two solid rubber wheels with metal rims (16" diameter)
- Foam filled flat free tires

Gas Cylinder Hook



Item Number	Description
BSQUADHOOK	Yellow Cylinder Neck Hook Adapter

Tote

- Blue plastic tote accessory ideal for oxy-fuel welding needs
- Lightweight for easy portability
- Made of tough lightweight polypropylene
- UL Listed
- Parts are Victor® Compatible



Item Number	Description
BS1020	Blue Star Plastic Tote

Track Torch

The Blue Star™ Track Torch is a precision automatic gas cutting torch. This tractor-type machine can be used on its own track for straight line cutting and a variety of welding operations. With the optional round rails, the BSTT200 can be used for circle cutting as well.

Features:

- Equipped with a single cone speed changer (mechanical non-stage speed changer) to materialize substantial compact and lightweight design
- Based on the double cone speed changer that has been successfully used on other versions
- Improved mobility and operability of the machine will contribute to the accuracy and labor saving of the cutting operation

Package includes:

- Main cutting unit
- Torch holder with rack
- Hose - 600 mm
- Cabtyre cord - 5m
- Tip ANM - 1/32", 3/64", 1/16"
- 6' Track

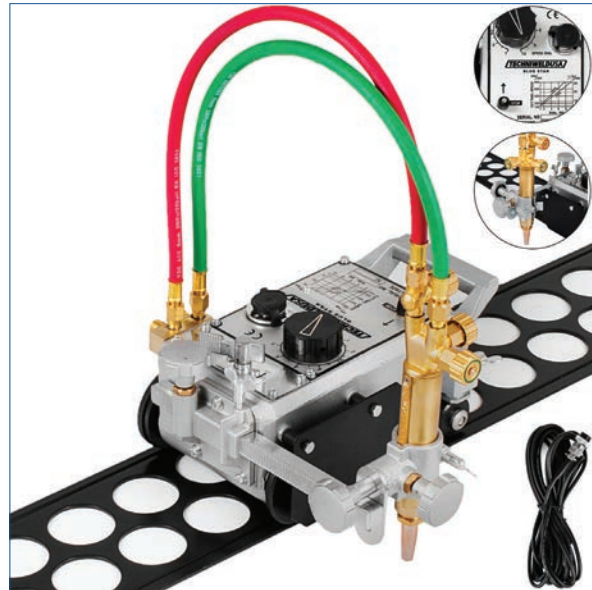

Motor	Cutting Speed	Cutting Thickness	Power Source
1500 RPM	150 - 800 mm/min	5-50 mm	110V (±10%)

Item Number
BSTT200 - (Track torch and 1 track)
BSTT200TH - (Torch holder and rack)
BSTT200TORCH - (Replacement torch)
BS33 - (#33 Nipple fitting)
BS32 - (#32 Nipple fitting)
BS1020-22 - (Oxygen Nut)
BS1020-23 - (Acetylene Nut)
TRACK - (Replacement 6' track)

Track

- UL Listed



Item Number	Description	Size
TRACK	F/BSTT200 Cutting Machine	6 ft



CHEM STAR

FOR ALL YOUR CHEMICAL RELATED PRODUCTS

Techniweld USA's, *Chem Star*™ aids in supplying the needs of welders in order to provide a safe welding and working environment. Chem Star™ provides all your chemical related products.

Anti-Spatter **69**
Zinc Galvanizing Spray
All-Purpose Brazing Flux
Aluminum Brazing Flux
Chem Sharp Kit
Tip Dip 337

Lube Pads & Lubricant **70**
Soap Stones
Anti-Spatter
Coolant Fluids

Metal Working Fluid **71**
Sanitizer Wipes
Gel Hand Sanitizer
Developer, Cleaner & Penetrant

Anti-Spatter

CS777 (16 OZ.)

Chem Star's Anti-Spatter for MIG gun nozzle and welding surfaces new quick dry formula to save time and reduce cost.

FEATURES AND BENEFITS

- Non-flammable
- Paint compatible
- Reduces clean up time
- Protects nozzles, diffusers, and tips
- Prevents weld spatter from sticking
- Prevents spatter adhesion on surface
- Reduces spatter build-up on MIG nozzles
- Heat-resistant to withstand high-temperature use
- Contains no silicones, fluorocarbons, or trichloroethane



Zinc Galvanizing Spray

CSBGALV (Bright Finish)

CSMGALV (Matte Finish)

FEATURES AND BENEFITS

- Prevents rust and corrosion
- Protects welded surfaces
- Repairs Hot-Dip Galvanizing with a matte finish
- Fast-Drying
- Heat resistant to 500°F
- May be top-coated



All-Purpose Brazing Flux

CHEMALLFLUX (16 OZ.)

CHEMALLFLUX1/2 (16 OZ.)

All-purpose brazing flux is used with low fuming bronze and nickel silver brazing alloys, steel, cast iron, copper-base alloys. It is applied to the rod by preheating the rod end and dipping the rod into flux.



Aluminum Brazing Flux

CS612 (8 OZ.)

Chem Star's all-purpose flux for torch brazing with aluminum alloys. It is especially effective with common aluminum base materials such as 1100, 3003, and 6061. The recommended filler metals are 4047 (718) and 4145.



Chem Sharp Kit

CSCHEMSTARPK

Chem Star's Tungsten Sharpening Kit is a Chemical sharpener for tungsten points.

FEATURES AND BENEFITS

- Economical- Over 500 perfect sharpenings without grinding or leaving the work area, and without contaminating the tungsten.
- Eliminates the probability of chipping
- Extends the life points 2 to 4 times
- Produces the perfect point every time



Tip Dip 337

CS337 (16 OZ. Plastic Jar)

CS337C (16 OZ. Metal Can)

Prevents spatter build-up. For protection of MIG gun nozzles, tips, and positioners

FEATURES AND BENEFITS

- Made in the USA
- Product is non flammable and odorless
- Product does not contain hydrocarbon solvents
- Extends the life of MIG consumables
- Product is safe, non-toxic and does not contain silicones



Lube Pads White

CS007061

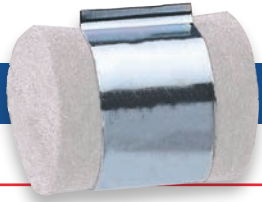

FEATURES AND BENEFITS

- Reduces tip and liner wear, burtback, wire jams and promotes smoother arc feed
- Cuts rust and dirt

For all types of wire. Excellent for aluminum wire. 6 pads per pack

Lube Pads Black

CS007060



FEATURES AND BENEFITS

- Reduces tip and liner wear, burtback, wire jams and promotes smoother arc feed
- Cuts rust and dirt

For all types of STEEL wire. Not recommended for aluminum wire. Pre-treated with lube. 6 pads per pack

Lube Pad Lubricant

CS007040



FEATURES AND BENEFITS

- 8 f. oz. (236 mL)
- Revitalize used pads
- Decreases jamming downtime
- Increase tip and liner life
- Removes dirt
- Cuts rust

Soap Stones

SSFLAT (Flat Soapstone)

CSSSHF (Flat Soapstone Holder)

SSROUND (Round Soapstone)

CSSSHR (Round Soapstone Holder)

SSFLATTHIN (Thin Soapstone)

CSSSHTHIN (Thin Soapstone Holder)

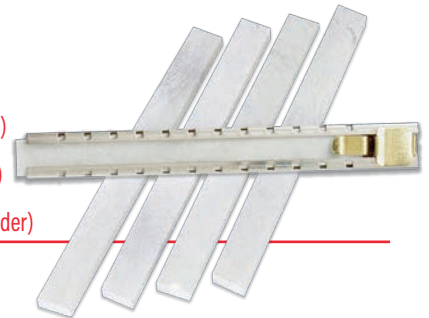

- #1 White select stone only
- Techniweld USA Soapstone is mined & cut, not pressed from scraps
- Techniweld USA Soapstone, being cut from mined stone holds point much longer

Anti-Spatter

CS500(1/5/55)

(1 Gallon, 5 Gallon & 55 Gallon)



Chem Star's Anti-Spatter for MIG gun nozzle and welding surfaces new quick dry formula to save time and reduce cost.

FEATURES AND BENEFITS

- Non-flammable
- Paint compatible
- Reduces clean up time
- Protects nozzles, diffusers, and tips
- Prevents weld spatter from sticking
- Prevents spatter adhesion on surface
- Reduces spatter build-up on MIG nozzles
- Heat-resistant to withstand high temperature use
- Contains no silicones, fluorocarbons, or trichloroethane

Coolant Fluids

KCI1625501 (Blue Coolant)

KCI1625502 (Red Coolant)

KCI1625503 (Green Coolant)



Specially formulated for use in all water circulating systems. Recommended for water cooled Plasma, MIG, TIG, Resistance Welding Systems, and general industrial applications.

Metal Working Fluid

CSMWF (1 Gallon)

Chem Star Metal Working Fluid is used broadly in machine shops as a multi-functional cutting fluid. It is primarily formulated to cool and lubricate the contact point of the tool and the work piece.

FEATURES AND BENEFITS

- Minimal separation- excellent emulsion even with hard water
- Cooling maximized by metal wetting. In addition, promotes good chip settling
- Good stability in storage-minimal tendency to turn rancid
- Helps prevent rusting or corrosion of the machined metals
- Minimizes surface foam
- Speeds the release of entrained air which could cause pump cavitation
- Good rust protection for steel work and machined parts even when water/oil emulsion ratios are 80:1
- Minimal foaming- possibility of sump overflow minimized
- Good ability to control bacterial growth and rancid odors
- Helps control the growth of bacteria, which is a constant problem in soluble oil circulating systems due to outside contamination
- Helps to prevent flash rust



Gel Hand Sanitizer

CSHS1LP (1 L. PUMP BOTTLE)

CSHS1G (1 GL. BOTTLE)

Gel Hand Sanitizer.
Ethyl Alcohol.



Sanitizer Wipes

CSHANDWIPE50



- 75% Ethyl Alcohol
- 7" x 6" Hand Sanitizer Wipes.
- Extra Soft and Thick Spunlace Nonwoven Fabric, Cottony soft & Infused with Aloe Extract and Honeysuckle Extract.
- FDA Registered Product.



Developer, Cleaner & Penetrant

CSD007 (15 Oz STD Developer NDT)

FEATURES AND BENEFITS

- Manufactured in the USA
- 15. oz aerosol non-halogenated solvent remover and cleaner for pre-cleaning surfaces
- Eliminates excess penetrant before application of developer during liquid penetrant testing
- Usable with a wide variety of substrates
- Clears away oils, greases, and other contaminants
- Dries fast and leaves almost zero residue

CSC007 (16 Oz STD Cleaner NDT)

FEATURES AND BENEFITS

- Manufactured in the USA
- 16. oz aerosol non-halogenated solvent remover and cleaner for pre-cleaning surfaces
- Eliminates excess penetrant before application of developer during liquid penetrant testing
- Usable with a wide variety of substrates
- Clears away oils, greases, and other contaminants
- Dries fast and leaves almost zero residue

CSP007 (12.5 Oz STD Penetrant NDT)

FEATURES AND BENEFITS

- Manufactured in the USA
- Aerosolized for use
- It is a light vanilla-scented, non-combustible substance during liquid penetrant testing
- Takes approximately 5 to 30 minutes of waiting time to settle on the surface
- Makes cleaning up a lot simpler
- Can easily spot breaking surface problems



FILLER METALS

FOR ALL YOUR MILD STEEL, ALUMINUM, STAINLESS, STEEL, NICKEL, AND ALL OTHER ALLOYS

Mild and Low Alloy Steel - Bare Wire, Electrode, Flux Cored Wire, Coated Electrode	73-77
Stainless Steel - Bare Wire, Coated Electrodes, Flux Cored Wire	77-82
Aluminum Alloys	82-83
Brazing Alloys	83
Bronze Alloys	84
Nickel Alloy - Bare Wire, Coated Electrodes	84-86
Cobalt Alloys	86-87
Titanium and Zirconium Alloys	87-88
Aerospace Alloys	88-89
Hardfacing - Electrodes, Wires	90-91
Maintenance & Repair/Hardfacing	91-93
Maintenance Alloys	93-95

Mild and Low Alloy Steel Bare Wire

AWS Designation	Tensile Strength	Yield Strength	Elongation	Description & Application
ER70S-2	93.2 ksi	78 ksi	25 %	ER70S-2 is triple deoxidized with aluminum, titanium and zirconium as well as manganese and silicon, makes this wire capable of producing efficient welds when the steel to be welded is rusty, dirty, undercoat painted or has mill scale. Premium wire for welding mild and low alloy steels as well as thin walled materials. It is recommended for pipe welding and for root passes in heavy vessel construction. Also for welding steels of which surface will be coated.
ER70S-3	78 ksi	60 ksi	25 %	A premium mild steel solid wire suitable for general purpose welding over clean to light levels of rust and mill scale. Frame fabrication, automotive structures, farm implements, construction equipment, pressure vessels, pipe fabrication, railcar construction and repair, general fabrication. Widely used in high-speed robotic and automatic welding applications and semi-automatic applications.
ER70S-6	87 ksi	74 ksi	28 %	A premium mild steel solid wire formulated to provide high quality welds and trouble-free performance from heavy duty, high speed, spray transfer applications all the way to light duty low speed, short arc applications. Frame fabrication, automotive structures, farm implements, construction equipment, pressure vessels, pipe fabrication, railcar construction and repair, general fabrication. Used in high-speed robotic and automatic welding applications and semi-automatic applications.
ER70S-B2L	75 ksi	58 ksi	19 %	ER70S-B2L is identical to ER80SB2, except for the low-carbon content (0.05 % max), which makes it more resistant to cracking and more suitable for welds to be left in the as-welded condition or when the accuracy of the post weld heat treatment operation is questionable. A preheat and interpass temperature of not less than 275°F should be maintained during welding. ER70S-B2L is used to weld 1/2Cr-1/2Mo, 1Cr-1/2Mo, and 1-1/4Cr-1/2Mo steels for elevated temperatures and corrosive service. It is also used for joining dissimilar combinations of Cr-Mo and carbon steels.
ER80S-B2	80 ksi	68 ksi	19 %	ER80S-B2 requires careful control of preheat, interpass temperatures, and post-weld heat treatment to prevent cracking. ER80S-B2 is classified after post-weld heat treatment. Special care must be taken when using it in the as-welded condition due to higher strength levels. Recommended shielding gas is CO ₂ or an Argon/CO ₂ mixture. Used to weld 1.25% chrome - .50% moly steels for elevated temperatures and corrosive service.
ER80S-B6	80 ksi	68 ksi	19 %	ER80S-B6 is used for elevated temperature creep service and with corrosion resistance against steam, hot hydrogen gas and high sulfur crude oils. A preheat and inter pass temperature of not less than 350°F should be maintained during welding. ER80S-B6 is used for joining 5%Cr and 1/2% molybdenum steels such as A336 Gr. F5, A155 Gr. 5 Cr, A335 Grs. P5 and P5b, A217 C5 (cast) and A199/ A213 Grs. T5 and T5b. Used primarily in the petrochemical and refinery industries.
ER80S-B8	80 ksi	68 ksi	19 %	ER80S-B8 is used for joining 9Cr-1Mo air hardening steels for elevated temperature creep service, and with corrosion resistance from steam, hot hydrogen gas, and high sulfur crude oils. These include steels such as A335 Grade P9, A336 Grade F9, A217 C12 (Cast), and A199, A200, and A213 grade T9. A preheat and interpass temperature of not less than 350°F should be maintained during welding. ER80S-B8 is used primarily in the petrochemical and refinery industries. It was designed for welding materials of similar composition.
ER80S-D2	106 ksi	90.2 ksi	22.5 %	A mild steel solid wire that contains 0.50 % Molybdenum for increased strength and high levels of manganese and silicon to provide good wetting, and good rust and scale tolerance. ER80S-D2 will give radiographic quality welds with excellent bead appearance in both ordinary and difficult-to-weld carbon and low alloy steels. It is suitable for single and multiple pass welding of carbon and low alloy steels and higher strength steels in the as welded and post weld heat treated conditions.
ER80S-B3L	N/A	N/A	N/A	ER80S-B3L is identical to ER90S-B3 except for the low-carbon content (0.05 percent maximum) and, therefore, the lower strength levels. It exhibits greater resistance to cracking and is more suitable for welds to be left in the as-welded condition. ER80S-B3L was previously ER90S-B3L. The strength requirements and classification designator have been changed to reflect the true strength capabilities of the chemical composition. Special care must be used when using it in the as-welded condition due to higher strength levels.
ER80S-Ni1	79 ksi	63 ksi	30 %	ER80S-Ni1 wire deposits weld metal containing a nominal 1% nickel, similar to an E8018C3 coated electrode. ER80S-Ni1 is used for welding low alloy high-strength steels that requires good toughness at temperatures as low as -50°F (-46°C).
ER80S-Ni2	91.3 ksi	78.3 ksi	28 %	ER80S-Ni2 is a mild steel solid wire that contains over 2% nickel. It will give radiographic quality welds with excellent bead appearance and is suitable for single and multiple pass welding. ER80S-Ni2 is used for welding of fine grain structural steels if low temperature impact values are required. For service temperatures down to -76 °F (-60 °C).
ER90S-B3	80 ksi	68 ksi	19 %	ER90S-B3 is a solid wire used to weld 2.25% chromium- 1% molybdenum steels. Careful control of preheat and interpass temperatures and post weld heat treatment is essential to prevent cracking. Used for high-temperature, high-pressure piping, pressure vessels, and in oil refinery and chemical plants.
ER90S-B9	110.1 ksi	97.1 ksi	20 %	ER90S-B9 is a solid wire suitable for 9% chromium steels such as P91, T91, and F91. ER90S-B9 is used to weld high-temperature steels for hot hydrogen service. Applications include steam generation and petrochemical equipment.
ER100S-1	104 ksi	92 ksi	16 %	ER100S-1 produces high tensile strength, high impact resistant weld deposits that retain their toughness to -70°F making it suitable for low temperature critical applications. ER100S-1 is meant for the welding of HY80 and HY100 steels.
ER110S-1	114 ksi	98.5 ksi	15 %	ER110S-1 produces high tensile strength, high impact resistant weld deposits that retain their toughness to -70°F making it suitable for low temperature critical applications. ER110S-1 is meant for the welding of HY100 steels as well as a variety of structural applications where tensile strength requirements exceed 100 ksi (690 MPa).
ER120S-1	120 ksi	105 ksi	15 %	ER120S-1 deposits high-strength, very tough weld metal for critical applications. ER120S-1 can be welded in all positions. Recommended shielding gas is CO ₂ or Argon/O ₂ mix. ER120S-1 was originally developed for welding HY100 steels for military applications, it is also used for a variety of structural applications where tensile strength requirements exceed 100 ksi (690 MPa), and excellent toughness is required to temperatures as low as -60°F (-51°C).
RG-45	45 ksi	N/A ksi	22 %	A copper coated gas welding rod that is used for welding ordinary low-carbon steel up to ¼" thick. It is recommended where ductility and machinability are most important. This rod is excellent for the welding of steel sheets, plates, pipes, castings and structural shapes where the minimum tensile strength requirement does not exceed 45 ksi (310 MPa).
RG-60	60 ksi	N/A ksi	20 %	The high silicon and manganese composition removes impurities from the molten metal thereby eliminating the need for flux. RG-60 is used to produce high tensile strength quality welds on low-carbon and low alloy steels. It is also used for the oxy-fuel gas welding of carbon steels, where the minimum tensile strength requirement does not exceed 60 ksi (415 MPa).

Mild and Low Alloy Steel Electrode

AWS Designation	Tensile Strength	Yield Strength	Elongation	Description & Application
E6010	76 ksi	61 ksi	26 %	E6010 is a quick-starting, cellulosic mild steel electrode that provides outstanding arc stability, penetration and wash-in. It produces an X-ray quality weld with light slag that's easy to remove. Can be used to weld the following API 5L steels: Grade A, B, X-42, X-46, X-52, X-56 and for the root pass on material up to X-80. Used for construction and shipbuilding, general purpose fabrication, maintenance welding, out-of-position X-ray welds, pipe welding and vertical and overhead plate welding. E6010 Electrode Color Code - PIPE MAGIC
E6010 Plus	72 ksi	60 ksi	25 %	E6010 Plus is a quick-starting, cellulosic mild steel electrode that provides outstanding arc stability, penetration and wash-in. It produces an X-ray quality weld with light slag that's easy to remove. It features enhanced weldability and increased physical properties. E6010 Plus can be used to weld the following API 5L steels: Grade A, B, X-42, X-46, X-52, X-56 and for the root pass on material up to X-80. Used for construction and shipbuilding, general purpose fabrication, maintenance welding, out-of-position X-ray welds, pipe welding and vertical and overhead plate welding.
E6011	77.7 ksi	63.2 ksi	25 %	A quick-starting mild steel electrode with stable arc characteristics and excellent penetration that produces a fine spray transfer. Excellent choice for welding on steels that cannot be completely cleaned or where the steel is rusty or painted. The slag detaches easily. Galvanized steel work, general fabrication, railroad cars, shipbuilding, construction, light sheet metal fabrication and structural work. E6011 Electrode Color Code - FILL GENIE
E6013	72.6 ksi	61.3 ksi	26.5 %	An all-purpose electrode that provides excellent arc stability. Can be used for light gauge metal and offers sufficient penetration for welding on heavier assemblies with light slag that's easy to remove. Ideal for general purpose fabrication, metal buildings, machine parts and shaft build-up. Suitable for welding hard to reach areas and spot welding. E6013 Electrode Color Code - ALLWELD
E6022	60 ksi	N/A Min	N/A Min	Designed for welding roof decking to support beams and other similar applications where burn-through spot welds with full penetration are required. It is also used to weld through galvanized or painted roof decking and can be used on plated and dirty decking as well. Burn-through spot welds for roof decking and sheet metal, rapid downhill welding to join light gauge materials.
E7014	79 ksi	68.1 ksi	27.5 %	A versatile, all-position electrode, with a smooth stable arc, that can be used with either AC or DC (electrode negative or electrode positive) power. It has a rutile base with an iron powder addition that serves to increase welder-appeal with its outstanding deposition rate and speed of travel. The slag detaches easily. Construction of frames, heavy sheet metal, and machine bases. E7014 Electrode Color Code - ALCHEMY ROD
E7016	70 ksi	58 ksi	22 %	E7016 is a basic coated electrode for making vertical-down fillet joints with a flat appearance at high speed. The slag is of the self-lifting type. E7016 is especially good on AC and is used in shipbuilding and structural engineering.
E7018/E7018-1	78.5 ksi	65.5 ksi	28 %	A general purpose electrode that provides excellent start and restart capabilities, and a smooth and virtually spatter free arc for superior weldability. Slag removal is one of the best and in many cases is self-peeling. It operates smoothly even on somewhat dirty or rusty surfaces. Petrochemical plants (pressure vessels, fittings, piping), steel structural work, field erections (buildings and bridges); mining equipment; some pipelines; rail car and locomotive construction; heavy equipment fabrication and repair, shipbuilding, drilling rigs; farm machines. E7018 Electrode Color Code -LIGHTNING BOLT
E7018 AC	81.2 ksi	73.1 Min	29.5 %	E7018 AC is highly recommended for applications using small 208/230V, single phase AC welders, E7018AC has good operator appeal, excellent re-striking characteristics and an extremely stable arc. E7018 AC is also an excellent choice for skip or tack welds. The slag is self-removing in most applications. E7018AC will work well on all AC power sources and performs exceptionally well on utility-type welders. E7018AC Electrode Color Code - SMOOTH GLIDE AC
E7018-A1	89 ksi	77 ksi	27 %	E7018-A1 is an outstanding welding electrode for welding the 0.50% molybdenum steel and other low alloy steels. The specially formulated coating resists moisture pick-up of high heat and humidity. E7018-A1 offers resistance to moisture reabsorption which helps prevent hydrogen cracking and aids in elimination of starting porosity. E7018-A1 is used primarily for pressure vessel applications. This includes construction and maintenance of boilers, piping and tubing.
E7024	82 ksi	72 ksi	25 %	An excellent high-speed electrode for fillet welds. It is exceptionally fast when used down hand in properly designed weld joints or in horizontal fillet welds where equal leg fillets are desired. When a drag welding technique is used, it operates well on either AC or DC (electrode negative) power. E7024 minimizes slag entrapment, and the slag is self-removing in most applications. Earth moving equipment, mining machinery, plate fabrication, railroad cars, structural, shipbuilding and mobile trailers. E7024 Electrode Color Code - JOINING WIZARD
E8018-B2	102 ksi	91 ksi	21 %	Used to produce high tensile strength quality welds on higher strength steels greater than 80,000 pounds. The coating is specially formulated to resist moisture pick-up under conditions of high heat and humidity, which helps prevent hydrogen cracking and aids in elimination of starting porosity. Used for fabrication and maintenance of boilers and piping made of heat resisting Cr-Mo alloyed steels. Weld metal is resistant to working temperatures up to 1058°F.
E8018-B3L	93.2 ksi	78 ksi	25 %	E8018-B3L is a low-carbon electrode designed for welding 2-¼ Cr - 1% Mo steels. The low-carbon content contributes to its crack resistance. It offers good arc stability, low spatter and high deposition efficiency. E8018-B3L's extra low-carbon content proves micro structure stability during high-temperature service applications, and pressure piping such as found in steam power generating equipment, boiler and heat exchanger steel tubes, marine equipment, chemical processing equipment and oil refinery equipment.

(Continued on next page)

AWS Designation	Tensile Strength	Yield Strength	Elongation	Description & Application
E8018-B6	96 ksi	80 ksi	24 %	E8018-B6 is an iron powder, low-hydrogen covered electrode designed for the welding of 5% Cr, 1/2% Mo steels and other chromium-molybdenum steels. Its special coating reduces moisture pick-up, minimizing hydrogen cracking and starting porosity. It strikes and re-strikes easily, and provides a stable arc that is easy to control. E8018-B6 is primarily used in the petrochemical and petroleum industries. Excellent for tubes, tube sheets, and plate steels for high-pressure hydrogen service.
E8018-B8	93 ksi	72 ksi	21 %	E8018-B8 is designed for joining creep-resistant, high chromium (9% Cr) alloys of similar composition. Its iron powder low-hydrogen coating reduces moisture pick-up and helps to minimize hydrogen cracking and starting porosity. It is the best choice when service conditions are too severe for E9018B3 or E8018B6. Ideal for use in the petrochemical and petroleum industries. Excellent for tubes, tube sheets, and plate steels for high-pressure hydrogen service, as well as 9% Cr, 1% Mo steels.
E8018-C1	91 ksi	80 ksi	26 %	E8018-C1 outstanding characteristics provide good puddle control with excellent wetting action and tie in, good arc characteristics and easy slag removal. The coating is specially formulated to resist moisture pick-up under conditions of high heat and humidity, that helps retard hydrogen cracking and aids in elimination of starting porosity. E8018-C1 is designed for use in the welding of nickel bearing steels for low temperature applications where toughness of the weld metal is important. Such applications include ship building, storage, piping and tanks used in the storage of gases.
E8018-C2	95 ksi	82 ksi	24 %	E8018-C2 is excellent for low temperature applications requiring tensile strengths greater than 80,000 psi and for welding 2% to 4% nickel steels. This electrode features a special formulated coating designed to reduce moisture pick-up and help minimize hydrogen cracking and starting porosity which makes it an outstanding choice in conditions of high heat or humidity. Used in shipbuilding, piping and gas storage tanks, as well as in the welding of AR and T-1 steels.
E8018-C3	82 ksi	70 ksi	28 %	E8018-C3 is designed for 80,000 tensile strength applications, and also 1% nickel applications. This electrode provides excellent puddle control with good wetting action and tie in. It offers good arc characteristics and easy slag removal, and will provide notch toughness of 20 ft lbs. at -40°F. The coating is specially formulated to resist conditions of high heat and humidity and offers resistance to moisture reabsorption. E8018-C3 is designed for use on 80,000 tensile steels of both commercial and military applications.
E801X-B6	89 ksi	73 ksi	23 %	E8015-B6, E8016-B6 & E8018B6 electrodes are used for welding base metal of similar composition (alloy 501 & 502), usually in the form of pipe or tubing. The alloy is an air-hardening material; therefore, when welding with E8015-B6, E8016-B6 & E8018-B6 preheat and post weld heat treatment are required. E801X-B6 was formally classified as E502 stainless steel under AWS A5.4-81. It is used in welding ASTM A 387 Grade 5 base material. X-denotes 5,6, & 8
E801X-B8	100 ksi	79 ksi	23 %	E8015-B8, E8016-B8 & E8018-B8 electrodes are used for welding base metal of similar composition (alloy 501 & 502), usually in the form of pipe or tubing. The alloy is an air-hardening material; therefore, when welding with E8015-B8, E8016-B8 & E8018-B8 preheat and post weld heat treatment are required. E801X-B8 was formally classified as E505 stainless steel under AWS A5.4-81. It is used in welding ASTM A 387 Grade 9 base materials. X-denotes 5,6, & 8
E9015-B9	122 ksi	104 ksi	18.2 %	E9015-B9 is designed for joining creep-resistant, high chromium (9% Cr-1% Mo-V) alloys of similar composition and is the best choice when service conditions are too severe for E9018B3, E8018B6, OR E8018B8 with improved creep resistance. Ideal for use in the petrochemical and petroleum industries, and for use in high-temperature service applications such as power generation and allied industries. Excellent for welding tubes and tube sheets, pipe and plate steels for high-pressure hydrogen service, as well as 9% Cr-1% Mo-V steels.
E9018-B3	112 ksi	95 ksi	21 %	Used to produce high quality welds on higher strength piping, castings and forgings. The coating is specially formulated to resist moisture pick-up under conditions of high heat and humidity, which helps prevent hydrogen cracking and aids in elimination of starting porosity. Used for welding boilers and piping made of heat resisting Cr-Mo alloyed steels, and nitrated steels. Weld metal is resistant to working temperatures up to 1112°F.
E9018-B3L	102 ksi	85 ksi	21 %	E9018-B3L is an outstanding electrode for welding high-strength piping, where cracking is a problem. It provides excellent notch toughness, 20 ft lbs minimum at 100°F. The coating is specially formulated to resist moisture pick-up under conditions of high heat and humidity and offers resistance to moisture reabsorption which helps prevent hydrogen cracking and aids in elimination of starting porosity. Definitely a preferred electrode with high operator appeal. E9018-B3L is used in welding chrome-moly pipes and boiler work.
E9018-B9	120.2 ksi	104.4 ksi	18 %	E9018-B9 is an iron powder low-hydrogen coated electrode designed to weld the modified 9% Chromium - 1% Molybdenum steels known by the designations T91, P91 or Grade 91. These steels are designed to provide improved creep strength, toughness fatigue and oxidation, and corrosion resistance at elevated temperatures. The low-hydrogen powder covering has good deposition with smooth arc, low spatter and easy slag removal. E9018-B9 is commonly used in maintenance and fabrication of base metals in the power generation, steam piping and equipment found in elevated operating temperatures.
E9018-M	100 ksi	89 ksi	24 %	E9018-M is an outstanding welding electrode for welding higher strength steels with tensile strength in excess of 90,000 psi. The coating is specially formulated to resist moisture pick-up under conditions of high heat and humidity. E9018-M offers resistance to moisture reabsorption to help prevent hydrogen cracking and aids in elimination of starting porosity. E9018-M is used for joining HY-90, HY-80, T-1 and other high tensile steels.
E10018-D2	112 ksi	97 ksi	25 %	E10018-D2 features good arc characteristics, crack resistance and ductility, is outstanding for welding low alloy, high-strength steels and manganese-molybdenum steels requiring tensile strengths of at least 100,000 psi. It's specially formulated coating, designed to reduce moisture pick-up and minimize hydrogen cracking and starting porosity, makes it great for conditions of high heat and humidity. E10018-D2 is excellent for manganese-molybdenum castings, alloy forgings, structural, and for pressure vessels in either as welded or stress relieved conditions.
E10018-M	104.4 ksi	95 ksi	24 %	Features good arc characteristics, crack resistance and high ductility. For welding low alloy, high-strength steels and manganese-molybdenum steels requiring tensile strengths of at least 100,000 psi. The coating is specially formulated to resist moisture pick-up under conditions of high heat and humidity, which helps prevent hydrogen cracking and aids in elimination of starting porosity. Excellent for manganese-molybdenum castings, alloy forgings, structural, and for pressure vessels in either as welded or stress relieved conditions.
E11018-M	110 ksi	101 ksi	21 %	Features good arc characteristics, low spatter, easy slag removal, crack resistance, and high ductility. This electrode provides excellent puddle control with good wetting action and tie in. For welding low alloy, high-strength steels which require weld joints with 100,000 psi minimum tensile strength, good ductility and crack resistance along with high notch toughness at temperatures of -60°F. Low alloy steels typically welded with E11018 include HY-80, HY-90, HY-100 and T-1 steels.

FILLER METALS

AWS Designation	Tensile Strength	Yield Strength	Elongation	Description & Application
E12018-M	138 ksi	116 ksi	20 %	Features good arc characteristics, low smoke level and high ductility. For welding low alloy, high-strength steels requiring tensile strengths of at least 120,000 psi. The coating is specially formulated to resist moisture pick-up under conditions of high heat and humidity, which helps prevent hydrogen cracking and aids in elimination of starting porosity. Slag removal is quick and easy. Typical applications include low alloy steels, forgings, castings, plate and pressure vessels, tempered steels, cementation steels, and other steels.

Mild and Low Alloy Steel Flux Cored Wire

AWS Designation	Tensile Strength	Yield Strength	Elongation	Description & Application
E70C-6M	87.2 ksi	78.9 ksi	25 %	A carbon steel, composite metal cored electrode for gas shielded arc welding. This electrode is for single and multiple-pass welding of carbon and certain low alloy steels, where a minimum tensile strength of 70,000 psi is required in the weld metal.
E70T-1	88.6 ksi	73 ksi	24 %	A carbon steel electrode with a unique slag system which allows multiple weld beads to be stacked in a horizontal fillet with a minimum of "roll" or convexity. This electrode is intended for single and multiple pass welding in flat and horizontal fillet positions. For use with carbon dioxide gas shielding. An excellent electrode for welding plates such as ASTM A36, A285, A515, and A516.
E70T-4	87.8 ksi	65 ksi	26.5 %	A carbon steel, flux cored electrode for use without external gas shielding in multiple pass welding of carbon steels. This electrode is intended for flat position welding of grooves and fillets and horizontal fillet welding with extremely high deposition rates. Ideally suited for welding applications where gas shielded electrodes may have problems, such as outdoors or in windy conditions.
E71T-1/T-9	89.1 ksi	78.1 ksi	26.3 %	E71T-1/T-9 is intended for single and multiple pass welding of carbon steels. Provides a stable arc, low spatter, easy to remove slag, and neat weld metal. For welding mild steel, and 490MPa grade high-strength steel. Use for ships, machinery fabrication, bridges, structures, steel frames, vessels etc.
71T-1M	89 ksi	78 ksi	26 %	E71T-1M is a flux cored wire that combines excellent performance features with the ability to produce high quality welds. This wire produces fillet welds with little spatter. Cleaning time is reduced because the slag cover is complete and can be easily removed. E71T-1M is designed for welding mild and medium-carbon steels and carbon-manganese medium steels. It can also be used over normal rust and mill scale. This high deposition wire offers excellent operator appeal for general steel fabrications and constructions such as plate sections, beams, girders, truck chassis/bodies, shipbuilding, earth moving equipment, storage tanks, bridge construction etc.
E71T-11	89.4 ksi	66.6 ksi	23.5 %	E71T-11 is a carbon steel, self-shielding flux cored wire designed for use without external gas shielding, in single or multiple pass welding having a smooth spray-type transfer. A flux cored wire intended for semi-automatic and automatic welding of carbon steel in single pass and limited multiple pass applications. Designed to operate on straight polarity (DCEN) and is well suited for butt, lap, and fillet welds steels from 16 gauge through 1/2". Due to its versatility it is excellent for assembly and maintenance.
E71T-GS	86.4 ksi	N/A	N/A	A carbon steel, self-shielded, flux cored wire that produces smooth arc action, low spatter, full slag coverage, and easy slag removal. Not having to use gas makes this product extremely popular due to its versatility and portability. This flux cored wire is intended for welding thin-gauge carbon steel. It's the natural choice for applications such as lap and butt welds on galvanized sheet metal, and high speed welds on sheet metal up to 3/16" thick, especially galvanized, aluminized, or other coated steels. The small diameters of this product work very well on the small 110 volt power source/feeders.
E80T1-B2	91 ksi	81.5 ksi	20 %	E80T1-B2 is a low alloy steel electrode for flux cored arc welding using 100% CO2 gas. It is designed for single and multiple pass welding in the flat and horizontal positions of certain chromium-molybdenum steel and pipe grades, where 1-1/4% Cr and 1/2% Mo are required in the weld deposit. E80T1-B2 is an excellent selection to weld steels subject to high-temperature service such as ASTM A387, Gr.11 plate and A335 P11 pipe.
E80T1-Ni1	86.4 ksi	73.7 ksi	27 %	E80T1-Ni1 is a gas-shielded electrode intended for single and multiple pass horizontal fillet and flat position welding of carbon and low alloy steels requiring a minimum tensile strength of 80,000 psi and good CVN toughness (30 ft. lbs. @ -20°F). E80T1-Ni1 is the ideal selection for welding steels combining moderate tensile strength and excellent CVN toughness, such as ASTM A572 Gr60, A302, A575, And A734.
E80T5-B2	94 ksi	82 ksi	25 %	E80T5-B2 is intended for single and multiple pass welding of certain chromium-molybdenum steels, plate and pipe requiring 1 1/4% chrome and 1/2% molybdenum in the weld deposit. The basic slag limits welding to horizontal fillets and the flat position. As with all basic slag electrodes, welder appeal is limited compared to rutile slag electrodes. E80T5-B2 is a good choice for welding steels such as ASTM A387 Gr 11 plate and A335 Gr P11 pipe. These steels are used in high-temperature applications requiring creep resistance. The basic slag imparts better CVN toughness than rutile slag electrodes when welding these steels, which are used in the construction of boilers, heat exchangers and pressure vessels.
E81T1-A1	93.3 ksi	84.6 ksi	23.5 %	E81T1-A1 is a low alloy steel electrode for flux cored arc welding with an external shielding gas. This electrode is intended for single and multiple pass welding, of certain C-Mo steels, where the addition of 1/2% of molybdenum is required in the deposited weld metal. E81T1-A1 is an ideal choice for welding certain C-Mo steels used in the fabrication of boilers and pressure vessels, such as ASTM A161, A204, and A302 Gr. A plate, and A335-P1 pipe. The 1/2 % Mo in the weld deposit increases the strength of the weld metal at elevated temperatures, and imparts some corrosion resistance. It does, however, reduce notch toughness somewhat.
E81T1-B2	94.2 ksi	84.2 ksi	20 %	E81T1-B2 is a low alloy steel electrode for flux cored arc welding with external gas shielding. This electrode is intended for single and multiple pass welding, of certain Cr-Mo steel plate and pipe, where 1/4% Cr and 1/2% Mo are required in the weld deposit. E81T1-B2 is intended to weld steels subject to high-temperature service, such as A387 Gr. 11 plate and A335 P11 pipe. These materials are used in the fabrication of boilers, heat exchangers, and pressure vessels.
E81T1-B2L	92.2 ksi	79.4 ksi	22 %	E81T1-B2L is a single and multiple pass premium low alloy steel electrode able to be welded in all positions of certain 1/4% Cr and 1/2% Mo steel plate and pipe where low-carbon levels are required in the weld deposit. E81T1-B2L is specially designed to weld thin-walled A335-P11 pipe or tube and well suited for use in the fabrication of pressure vessels, heat exchangers and boilers.
E81T1-B6	89 ksi	79.2 ksi	19.9 %	E81T1-B6 is a low alloy steel electrode intended for single and multiple pass, welding of certain chromium-molybdenum steels where a weld deposit of 5 % chromium and 1/2 % molybdenum is required. This electrode has superb welder appeal and excellent mechanical properties with smooth arc transfer, low spatter, and fast freezing slag. E81T1-B6 is specially formulated for welding tube, pipe and plate subjected to high-temperature service, such as A213-T5 and A335-P5.

(Continued on next page)

AWS Designation	Tensile Strength	Yield Strength	Elongation	Description & Application
E81T1-B8	96.3 ksi	78 ksi	20 %	E81T1-B8 is a flux cored electrode formulated for single and multiple pass welding of 9% chromium and 1% molybdenum steels. E81T1-B8 is used to weld 9Cr-1Mo steels such as A335-P9 piping and A213-T9 tubing. Typical applications involve high-temperature service in the petrochemical and petroleum industries.
E81T1-Ni1	83.5 ksi	76.9 ksi	23.5 %	E81T1-Ni1 is a low alloy steel electrode for flux cored arc welding with external gas shielding. This electrode is intended for single and multiple pass welding, on carbon and low alloy steels requiring good charpy v-notch toughness at subzero temperatures. E81T1-Ni1 is an ideal selection for welding steels requiring good tensile strength in excess of 80,000 psi and charpy v-notch toughness (20 ft lb f) as low as -40°F. Steels welded with this electrode include ASTM A572, A302, A588, and A734 used in the fabrication of transmission poles, light poles, earth moving and mining machinery, and offshore platforms.
E81T1-Ni2	87 ksi	73 ksi	26 %	E81T1-Ni2 is an excellent selection for welding steels which require good CVN toughness and tensile strength in the range of 80,000-100,000 psi. E81T1-Ni2 is designed for single and multiple pass welding of carbon and certain low alloy steels such as ASTM A572, A575 and A734. E81T1-Ni2 is ideal for applications such as offshore platform construction, shipbuilding, earth moving and mining machinery.
E81T1-W2	91 ksi	81.5 ksi	24 %	E81T1-W2 is a gas-shielded, flux cored, low alloy steel electrode for welding of weathering steels. This electrode is intended for single and multiple pass welding. Welder appeal is excellent with a spray transfer, thin slag which removes easily and cleanly, and a smooth bead profile. E81T1-W2 contains alloy additions which match those of the "weathering" steels such as ASTM A588. This provides weld metal which matches the corrosion resistance and coloring of the weathering-type structural steels commonly used in bridge construction and other structural components used in highway construction.
E91T1-B3	102.1 ksi	87.4 ksi	18 %	E91T1-B3 is specifically formulated for welding materials subjected to high-temperature service using both 100% CO2 and 75% Argon- balance CO2 gas. E91T1-B3 provides single and multiple pass, all position welding of certain chromium-molybdenum steels. E91T1-B3 is designed for welding materials such as A387 Gr. 22 plate and A335 P22 pipe and leaves 2¼% Cr / 1% Mo weld metal deposit.
E91T1-B9	106.9 ksi	86.1 ksi	19 %	E91T1-B9 is a flux cored electrode containing small additions of niobium, vanadium and nitrogen to improve long term creep properties; designed for single and multiple pass welding of 9% chromium and 1% molybdenum steels. E91T1-B9 is used to weld 9Cr-1Mo creep resistant steels, such as A387 Gr 91 plate; A335 P91 and A369-FP91 piping; A199-T91, A200-T91 and A213-T91 tubing; A182-F91 forgings; as well as fittings and castings of similar composition. Typical applications include power plant turbine casings, valves, headers and piping.
E91T1-K2	103.4 ksi	91.7 ksi	22 %	E91T1-K2 is a gas-shielded, flux cored electrode intended for single and multiple pass welding of certain low alloy steels. It is ideal for weldments requiring 90,000 psi minimum tensile strength and good CVN toughness values. E91TK2 has a rutile based slag system and excellent subzero CVN toughness and exceptional weld bead geometry with a smooth spray arc transfer with low spatter. E91TK2 is typically used to weld steels involved in the fabrication of submarines, offshore platforms and leg assemblies, earth moving machinery and specialized structural applications. These steels are usually types such as HY-80, HY-100, ASTM A710, A514 and other similar high-strength steels.
E100T1-K3	105.7 ksi	94 ksi	23 %	E100T1-K3 is a gas-shielded, low alloy steel electrode for flux cored arc welding of certain high-strength low alloy steels. This electrode is intended for single and multiple pass welding in horizontal fillets and the flat position. This electrode exhibits good bead profiles, with excellent slag detachment, providing a smooth spray transfer, full slag coverage, and relatively low spatter levels. E100T1-K3, with a minimum tensile strength of 100 ksi and good CVN toughness levels, is an ideal selection for welding steels such as A514 and HY-80 typically used in fabrications such as heavy crane assemblies, mining machinery, and large earth moving equipment.
E4130-LN	106.9 ksi	98.6 ksi	20.8 %	E4130-LN is a basic flux cored electrode for use with Ar-25% CO2 shielding gas. The deposit contains less than 1% nickel making this electrode suitable for most oil field applications. This electrode is intended for flat and horizontal fillet welding. E4130-LN is designed to weld E4130, and other steels of similar composition, such as E4140 and E8630. It provides a close match to steel properties following post weld heat treatment.

Mild and Low Alloy Steel Coated Electrode

AWS Designation	Tensile Strength	Yield Strength	Elongation	Description & Application
E4130	N/A	N/A	N/A	E4130 is used to weld heat-treatable, low alloy SAE E4130 and E8630 steels and steel castings with comparable hardening characteristics. Preheat between 400 - 600°F (204 - 316°C), with the same temperature held at interpass, in order to prevent cracking.
E4140	N/A	N/A	N/A	E4140 is used for welding SAE 4140 and similar heat-treatable steel where the weld metal must match the heat treating properties of the parent metal. Preheat between 400 - 600°F (204 - 316°C), with the same temperature held at interpass, in order to prevent cracking.
E4340	N/A	N/A	N/A	E4340 is used for welding heat treatable, high-strength steels SAE 4130, 4330, 4340 and steel castings with similar hardening properties. Preheat between 400 - 600°F (204 - 316°C), with the same temperature held at interpass, in order to prevent cracking.

Stainless Steel Bare Wire

AWS Designation	Tensile Strength	Yield Strength	Elongation	Description & Application
ER308/308H	88.5 ksi	59.5 ksi	39 %	ER308/308H is used for TIG, MIG, and submerged arc welding of unstabilized stainless steels such as types 301, 302, 304, 304H, 305, 308, and 308H. This filler metal is the most popular grade among stainless steels. Carbon content in the range of .04 - .08 provides higher strength at elevated temperatures. Used for general purpose applications where corrosion conditions are moderate. Can also be certified as 308H.
ER308/308L	85 ksi	57 ksi	40 %	This classification is the same as ER308/308H, except for the carbon content is held to a maximum of .03%. This increases the resistance to intergranular corrosion without the use of stabilizers such as columbium (niobium) or titanium. Strength of this low-carbon alloy, however, is less than that of the columbium (niobium)-stabilized alloys or type 308H at elevated temperatures. Used to weld base metal of similar composition such as 304L, 321, and 347.

(Continued on next page)

FILLER METALS

AWS Designation	Tensile Strength	Yield Strength	Elongation	Description & Application
ER308LSi	85 ksi	59 ksi	39 %	This classification is the same as ER308L, except for the higher silicon. This improves the usability of the filler metal in the gas metal arc welding process. If the dilution by the base metal produces a low ferrite or fully austenitic weld, the crack sensitivity of the weld is somewhat higher than that of a lower silicon content weld metal. Used to weld base metal of similar composition such as 301, 302, 304, 304L, 305, 308, 308L and 347.
ER309/309H	85.5 ksi	59.5 ksi	34 %	ER309/309H is used for the welding of similar alloys in wrought or cast form. Used primarily for welding dissimilar materials such as mild steel to stainless steel, as well as for a barrier layer in stainless overlays. For some applications, welding of straight chromium steels can be accomplished with this consumable.
ER309L	85 ksi	58 ksi	36 %	ER309L is of similar composition as ER309 except for the carbon content being lower than .03%. This lower carbon content reduces the possibility of intergranular carbide precipitation. This increases the resistance of intergranular corrosion without the use of stabilizers such as columbium (niobium) or titanium. Strength of this low-carbon alloy; however, may not be as great at elevated temperatures as that of the columbium (niobium)-stabilized alloys or 309. ER309L is preferred over ER309 for cladding over carbon or low alloy steels, as well as for dissimilar joints that undergo heat treatment.
ER309LSi	89.5 ksi	60.5 ksi	35 %	ER309LSi is of the same chemical composition as ER309L, with higher silicon content to improve the bead appearance and increase welding ease. This filler metal is used for welding of similar alloys in wrought or cast form. ER309LSi is mostly used for welding dissimilar materials such as mild steel to stainless steel, as well as for a barrier layer in stainless overlays. The weld beads are exceptionally smooth due to good wetting.
ER309LMo	84.1 ksi	65.25 ksi	28 %	ER309LMo is well suited for austenitic ferritic joints with a maximum application temperature of 572° F. It is also suited for stainless with wet corrosion up to 662° F. ER309LMo is used for the welding of dissimilar materials between stainless and low alloy steels, as well as for overlay cladding and for depositing buffer layers when welding clad products. ER309LMo can be used for joining unalloyed/low-alloy steels/cast steel grades or stainless/heat-resistant chromium steels/cast steel grades to austenitic steels/cast steel grades.
ER310	89.5 ksi	60.5 ksi	34 %	ER310 is used for the welding of stainless steels of similar composition in wrought or cast form. The weld deposit is fully austenitic and calls for low heat during welding. This filler metal can also be used for dissimilar welding. Used for the welding of stainless steels of similar composition in wrought or cast form. Can also be used for dissimilar welding.
ER312	109.5 ksi	78.5 ksi	25 %	ER312 is designed for welding stainless steels to mild steels as well as high-strength steels. ER312 gives a two-phase weld deposit with substantial percentages of ferrite in an austenite matrix. ER312 is used to weld cast alloys of similar composition and is used to weld dissimilar metals such as carbon steel to stainless steel, particularly those grades high in nickel and weld overlays. When welding similar cast alloys, limit welding to two or three layers only.
ER316/316H	88.5 ksi	59 ksi	35 %	ER316/316H with its presence of molybdenum increases its creep resistance at elevated temperatures & pitting resistance in a halide atmosphere. The lower ferrite level of this nominal composition reduces the rate of corrosion in certain media and is suitable for use at cryogenic temperatures. ER316/316H is used for joining type 316 and similar alloys as well as to weld wrought and cast forms of similar composition.
ER316/316L	86 ksi	58 ksi	36 %	ER316/316L has the same analysis as ER316, except that the carbon content is limited to a maximum of 0.03% in order to reduce the possibility of formation of intergranular carbide precipitation. ER316/316L is primarily used for welding low-carbon molybdenum-bearing austenitic alloys. ER316/316L is not as strong at elevated temperatures as ER316H. Because of the molybdenum, this product has increased creep resistance at elevated temperatures, as well as pitting resistance in marine and industrial environments.
ER316LSi	86.5 ksi	58.5 ksi	36 %	ER316LSi is a general purpose bare wire electrode developed for GMAW and GTAW welding. ER316LSi, which is a higher silicon wire designed to provide a smooth bead appearance and improved wetting action. Higher productivity could be realized in MIG welding. ER316LSi bare wire electrode applications include piping systems, food service equipment, chemical processing plants and pharmaceutical facilities.
ER317L	84.5 ksi	58 ksi	35 %	ER317L was especially developed for welding in severely corrosive environments where crevice and pitting corrosion are of concern. In addition to the resistance to pitting and crevice corrosion, the deposit made with this consumable offers good resistance to intergranular corrosion. ER317L bare wire is particularly well suited for welding in paper industry facilities, food processing plants, chemical processing facilities and in marine environments.
ER320	87.5 ksi	59 ksi	34 %	ER320 is designed to weld base metals of similar compositions for applications where resistance to severe corrosion involving a wide range of chemicals including sulfuric and sulfurous acids and their salts is required. The addition of copper and columbium to the alloy content provides resistance to intergranular corrosion. ER320 can be used for welding wrought and cast alloys of similar composition without post weld heat treatment. Utilized for pipe welding, 320 produces high purity weld deposit and reduces weld metal fissuring while maintaining corrosion resistance.
ER320LR	86.0 ksi	57.5 ksi	35 %	ER320LR has a composition similar to ER320, except that carbon, silicon, phosphorus, and sulfur levels are kept at lower levels as well as the columbium and manganese being specified at a narrower range. The low melting residuals are limited in this alloy to reduce the possibility of microfissuring. It is for this reason that this alloy is often used for welding type 320 stainless steels. ER320LR is primarily utilized for pipe welding. ER320LR is used to weld metals with similar composition in wrought and cast forms.
ER330	84.0 ksi	56.5 ksi	29 %	ER330 is used where heat and scale resisting properties above 1800°F are required. However, high sulfur environments can adversely affect elevated temperature performance. ER330 is used in repairs of defects in alloy castings and wrought alloys of similar composition used in heat treating and furnace industries.
ER347	86.5 ksi	57.0 ksi	35 %	ER347 has columbium added to its composition as a stabilizer. The addition of columbium reduces the possibility of intergranular chromium carbide precipitation and thus susceptibility to intergranular corrosion. Tantalum and columbium are both good at stabilizing carbon and in providing high-temperature strength. Typical applications include welding, repairing and overlaying of stabilized grades of stainless steel, like type ER347 and type ER321. ER347 is used in the refinery industry to combat high-temperature erosion corrosion and fatigue. ER347 is normally used to weld AISI 321 since titanium will not transfer across the arc.
ER347Si	N/A	N/A	N/A	ER347Si is the same as ER347, except for the higher silicon content. This improves the usability of the filler metal in the gas metal arc welding process. If the dilution by the base metal produces a low ferrite or fully austenitic weld, the crack sensitivity of the weld is somewhat higher than that of a lower silicon content weld metal.

(Continued on next page)

AWS Designation	Tensile Strength	Yield Strength	Elongation	Description & Application
ER385 (904L)	N/A	N/A	N/A	ER385 is used primarily for welding of ASTM B625, B673, B674, and B677 (UNSN08904) materials for the handling of sulfuric acid and many chloride containing media. It may also be used to join type 317L material where improved corrosion resistance in specific media is needed. ER385 may be used for joining UNS N08904 base metals to other grades of stainless steel. The elements C, S, P, and Si are specified at lower maximum levels to minimize weld metal hot cracking, and fissuring (while maintaining corrosion resistance) frequently encountered in fully austenitic weld metals.
ER409Nb	N/A	N/A	N/A	ER409Nb is the same as ER409 except that niobium (columbium) is used instead of titanium to achieve similar results. Oxidation losses across the arc are generally lower. It is used to weld ER409 stainless steel. The greatest usage is for applications where thin stock is fabricated into exhaust system components.
ER409Cb	86.5 ksi	57.0 ksi	35 %	ER409Cb is a ferritic stainless steel welding wire modified with the element of columbium. This improves corrosion resistance, increased strength at high-temperatures, and promotes ferritic microstructure. ER409Cb is a special purpose heat-resisting alloy with excellent weld metal flow and smooth bead appearance designed for MIG welding of exhaust manifolds, catalytic converters in the automotive industry.
ER410	N/A	N/A	N/A	This 12 Cr alloy (wt.%) is an air-hardening steel. Preheat and post heat treatments are required to achieve welds of adequate ductility for many engineering purposes. ER410 is used to welding ER403, ER405, ER410, and ER416 stainless. It is also used for deposition of overlays on carbon steels to resist corrosion, erosion, or abrasion.
ER410NiMo	118.5 ksi	92.0 ksi	20 %	ER410NiMo bare welding wire is a martensitic stainless steel. Normally the chromium is kept low and the nickel high to avoid ferrite formation in the weld metal. Preheating and interpass temperature of not less than 300°F are required. Post-weld heat treatment should not exceed 1150°F, as higher temperatures may result in hardening. Typical applications include welding, repairing and overlaying of type ER410 and ER410NiMo castings and wrought materials. Used in the hydropower industry to combat erosion corrosion. Normally ER410NiMo has better weldability than ER410 due to its low-carbon content.
ER420	145 ksi	120 ksi	45 %	ER420 is a martensitic stainless steel with properties similar to ER410 except slightly higher chromium and carbon contents. It requires preheat and interpass temperatures of not less than 400°F, followed by slow cooling. ER420 is used for many surfacing applications that call for superior resistance to abrasion due to its higher hardness and increased wear resistance over the weld metal of 410.
ER430	77.5 ksi	59.0 ksi	25 %	ER430 is a ferritic stainless steel which offers good ductility in heat-treated condition. This carefully balanced composition provides outstanding resistance at temperatures up to 1600°F. Preheating of the joint to a minimum of 300°F is recommended before welding. In addition to the applications of welding similar alloys, it is also used for overlays and thermal spraying.
ER630	150 ksi	135 ksi	10 %	ER630 is a precipitation hardening, martensitic stainless steel used for welding of materials of similar chemical composition. Mechanical properties of this alloy are greatly influenced by the heat treatment. Typical applications include valves, fasteners, gears, propeller shafts, and roller chain pins.
ER2209	150 ksi	135 ksi	10 %	ER2209 bare welding wire is used to weld standard duplex stainless steels such as 31803. The weld metal possesses a high tensile & yield strength along with moderate ductility. This grade has very good resistance to stress corrosion cracking & pitting corrosion with a typical pitting resistance equivalent number of 32-36. Used for pipe work and general fabrication in the offshore oil, gas and chemical process industries. Alloy offers high-strength with good ductility and excellent corrosion resistance.
ER2553	128.4 ksi	98.6 ksi	26 %	ER2553 is a super duplex alloy with austenite distributed within a ferrite matrix. Good general corrosion resistance to a variety of media, with a high level of resistance to chloride pitting and stress-corrosion cracking. Useful service limited to 500°F (260°C) maximum. ER2553 is used primarily to weld duplex stainless steels which contain approximately 25 percent chromium.
ER2594	128.4 ksi	98.6 ksi	26 %	Superduplex grade ER2594 electrodes provide matching chemistry and mechanical property characteristics to wrought superduplex alloys such as ER2507 and Zeron 100 as well as superduplex casting alloys (ASTM A890). The welding wire is overalloyed 2 - 3 percent in Nickel to provide the optimum ferrite/austenite ratio in the finished weld. This structure results in high tensile/yield strength and superior resistance to SCC and pitting corrosion.

Stainless Steel Coated Electrodes

AWS Designation	Tensile Strength	Yield Strength	Elongation	Description & Application
E2209-16	115.0 ksi	90.0 ksi	27 %	E2209-16 combines high-strength with improved pitting and SCC resistance. It has a smooth running arc that results in a uniform bead that is flat to slightly convex. E2209-16 is specially formulated for welding 22 Cr-5 Ni-3 Mo (type 2205) duplex stainless steels.
E308/308H-16	86.0 ksi	65.0 ksi	41 %	E308/308H-16 coated electrodes are used for welding unstabilized 18-8 stainless steels such as types 301, 302, 302B, 303, 308Se, 304, 305, and 308. The 308 electrodes provide corrosion resistance and physical properties equal to or greater than the steels for which they are recommended. Weld deposits, when ground and finished, cannot be distinguished from the base metal. Typical applications include dairy, distillery, restaurant equipment, and chemical and refining industry equipment. -15 coatings available upon request.
E308/308L-16	83.0 ksi	64.0 ksi	42 %	E308L/308L-16 is a low-carbon content electrode. The weld deposit contains a maximum of 0.04% carbon, which minimizes the formation of chromium carbides, and consequent susceptibility to intergranular corrosion. The weld deposit, with controlled ferrite, gives excellent notch toughness at -320°F (-196°C). It has a smooth running arc that results in a uniform weld bead that is flat to slightly convex. E308L/308L-16 is primarily designed for welding type 308L base metal with low or medium carbon content. Excellent for welding 18Cr-8Ni steels. -15 and -17 coatings available upon request.
E309/309H-16	88.0 ksi	67.0 ksi	37 %	E309/309H-16 is an all position electrode. It yields a uniform weld bead that is flat to slightly convex. E309/309H-16 is primarily designed for welding type 309 metal but can also be used for 18-8 clad steels or dissimilar materials if the alloy content is sufficiently high for a sound, ductile deposit. -15 coatings available upon request.
E309Cb-16	88.0 ksi	67.0 ksi	37 %	E309Cb-16 is an electrode designed to run on direct current, reversed polarity as well as alternating current. The weld deposit of this electrode is similar to that of E309L-16, with the addition of columbium, which stabilizes the alloy against intergranular corrosion. This electrode is used for joining type 347 steels and for welding 347 type steels to low or non-alloyed steels. It is also suitable for overlay welding where a Cb-stabilized weld deposit is desired.

(Continued on next page)

FILLER METALS

AWS Designation	Tensile Strength	Yield Strength	Elongation	Description & Application
E309L-16	79.0 ksi	64.0 ksi	38 %	E309L-16 has a low-carbon content (0.04% maximum) for reduced susceptibility to sensitization during high-temperature service. It has a smooth running arc that results in a uniform weld bead that is flat to slightly convex. E309L-16 outstanding for welding dissimilar metals such as weld overlay or for type 309 stainless steel to low alloy steels. Primarily designed for welding type 309 metal but can also be used for 18-8 clad steels. -15 and -17 coatings available upon request.
E309Nb-16	79.0 ksi	64.0 ksi	38 %	E309Nb-16 has the same composition of weld metal deposited by E309-16, except for the addition of columbium (niobium) and a reduction in the carbon limit. The columbium (niobium) provides resistance to carbide precipitation and thus increases intergranular corrosion resistance and also provides higher strength in elevated temperature service. E309Nb-16 electrodes are used also for welding type 347 clad steels or for the overlay of carbon steel. E309Nb-XX was formerly named E309Cb-XX. The change was made conform to the worldwide uniform designation of the element niobium.
E309Mo-16	80 ksi	79.7 ksi	30 %	E309Mo-16 has the same composition of weld metal deposited by E309-16, except for the addition of molybdenum and a small reduction in the carbon limit. It is used for welding type 316 clad steels or for the overlay of carbon steels.
E309MoL-16	80 ksi	79.7 ksi	30 %	E309MoL-16 is an all position electrode designed for applications requiring molybdenum with a standard 309L analysis. E309MoL-16 is used primarily for welding type 316 and 316L clad steels, or welding Mo containing austenitic stainless steel to carbon steel, provided the service temperature is less than 600°F.
E310-16	86.0 ksi	63.0 ksi	40 %	E310-16 is considered a general purpose electrode used mainly for welding AISI 310 stainless steel but also for straight chromium stainless as well as almost any analysis of carbon and alloy steel. The weld deposit is fully austenitic, and as such calls for minimum heat input during welding. It has a smooth running arc that results in a uniform weld bead that is flat to slightly convex. E310-16 is ideal for welding and building up parts for heat treatment and case hardening furnaces, cement kilns and other burners subject to high-temperature and oxidation in a non-sulphurous atmosphere.
E310Mo-16	78.0 ksi	91.0 ksi	12 %	E310Mo-16 is an electrode designed to run on direct current, reversed polarity as well as alternating current. E310Mo-16 electrodes are intended for the welding of type 316 clad steels. Other grades of molybdenum-bearing stainless steel may also be successfully welded with this type. This electrode is also used for relining digesters in the paper industry.
E312-16	115.0 ksi	95.0 ksi	25 %	E312-16 is one of the most widely used stainless steel electrodes for arc welding. It offers outstanding performance with a directional arc and self-detaching slag. It has a smooth running arc that results in a uniform weld bead that is flat to slightly convex. E312-16 electrodes are used for welding wrought and cast alloys of similar composition as well as for welding of dissimilar joints of type 312 metals. The weld deposits exhibit high tensile strength and offer fair resistance to abrasion making it ideal for new fabrication or repair maintenance applications.
E316/316H-16	85.0 ksi	68.0 ksi	42 %	E316/316H-16 is a fully alloyed core wire, featuring a rutile basic coating, that produces weld deposits with smooth bead appearance and easy slag removal. It can be used in any position, however it is best suited for flat and horizontal fillet welding. It has a smooth running arc that results in a uniform weld bead that is flat to slightly convex. E316/316H-16 electrodes are excellent for welding type 316 steel. Most commonly used in industries which use acid, gas, water and steam in manufacturing, requiring increased corrosion resistance of molybdenum bearing steels. Also used as a build-up on sealing faces of valves and fittings.
E316/316L-16	82.0 ksi	61.0 ksi	42 %	E316/316L-16 electrodes are similar to E316/316H-16, except the carbon is limited to a maximum of 0.04%, to reduce the possibility of carbide precipitation and consequent intergranular corrosion. Precise control of the carbon content in E316/316L electrodes provides a weld deposit matching the corrosion resistant qualities of type 316/316L stainless steel. It has a smooth running arc that results in a uniform weld bead that is flat to slightly convex. E316/316L-16 is excellent for welding stainless steel types 316, 316L and 318. The welds corrosion and fissuring resistance make it an excellent choice for critical applications requiring reduced susceptibility to sensitization during welding. -15 coatings available upon request.
E317L-16	92.0 ksi	69.0 ksi	35 %	E317L-16 with its increased molybdenum content results in higher tensile strength and improved corrosion resistance, as well as greater high-temperature creep strength than 316L-type electrodes. It is also highly resistant to moisture pick-up. It has a smooth running arc that results in a uniform bead that is flat to slightly convex. E317L-16 electrodes are used mainly for the welding of 18% Cr - 12% Ni - 3% Mo stainless steels. This electrode is typically used where strong corrosion resistance against sulfuric or sulfurous acids is required such as in the chemical, paper and textile industries.
E320-16	86.0 ksi	59.0 ksi	33 %	E320-16 electrodes are designed for welding alloys of similar composition in wrought and cast forms, with exceptional corrosion resistance to a wide range of chemical environments. With carbon, silicon, phosphorus and sulfur controlled to lower limits, and columbium and manganese kept to a narrow range, this composition is designed to reduce the possibility of microfissuring. Low heat input, however, is advisable for welding. E320-16 will produce weld deposits which resist corrosion, pitting, and cracking from sulfuric acid, phosphoric acid, and other chemicals.
E320LR-16	85.0 ksi	57.0 ksi	34 %	E320LR-16 flux-coated electrodes are a modified version of 320 electrodes, where the "residuals" carbon, silicon, phosphorus and sulfur are specified at lower maximum levels. Columbium and manganese are also maintained within tighter parameters. These strict controls eliminate hot cracking and microfissuring frequently encountered in austenitic stainless steel. E320LR-16 is designed for welding on alloy 20 and alloy 20 Cb-3® or alloys of similar composition in wrought or cast forms.
E330-16	84.5 ksi	57.0 ksi	26.5 %	E330-16 electrodes have a high nickel content which gives the weld deposit a strong adherent surface oxide that resists scaling at elevated temperature above 1800°F. High sulfur environments adversely affect the high-temperature performance. Heat input has to be kept to a minimum during welding to avoid the possibility of microfissuring. E330-16 electrodes are used primarily for repairing defects in wrought and cast forms of stainless steels of similar chemical composition.
E347-16	95.0 ksi	63.0 ksi	36 %	E347-16 columbium stabilized stainless steel electrodes. The columbium content is approximately ten times the carbon content, which reduces the possibility of intergranular carbide precipitation. E347-16 produces weld deposits with smooth bead appearance and easy slag removal. E347-16 used for the welding of types 302, 304, 321, and 347 stainless and stainless clad steels. Due to the strengthening effect of columbium, this grade is recommended if the weld metal is to be subjected to high-temperatures above 700°F.
E385-16	75 ksi	75.4 ksi	30 %	E385-16 is used primarily for welding type 904L materials for the handling of sulphuric acid and many chloride-containing media. E385-16 also may be used to join type 317L material where improved corrosion resistance in specific media is needed. It can also be used for joining type 904L base metal to other grades of stainless. The elements C, Si, P and S are specified at lower maximum levels to minimize weld metal hot cracking and fissuring (while maintaining corrosion resistance) frequently encountered in fully austenitic weld metals.

(Continued on next page)

AWS Designation	Tensile Strength	Yield Strength	Elongation	Description & Application
E410-16	92.5 ksi	78.0 ksi	21 %	E410-16 electrodes are used for welding 410 straight chromium steels where good strength and ductility, as well as corrosion and oxidation resistance at temperatures as high as 1500°F is a requirement. This material, being an air-hardening type, calls for a preheat and interpass temperature of not less than 400°F (200°C) during welding. E410-16 is also used for welding AISI 403, 405, 414, 416 and 420 stainless steels, for overlaying carbon steels to provide corrosion, erosion and abrasion resistance, and as a build-up on sealing faces of gas, water and steam fittings which are made from unalloyed or low-alloyed steels.
E410NiMo-16	134.0 ksi	123.0 ksi	18 %	E410NiMo-16 electrodes are similar to 410 electrodes but contain molybdenum and a higher nickel content for improved corrosion resistance at elevated temperatures. Preheat and interpass temperatures of not less than 300°F are recommended during welding. Post-weld heat treatment should not exceed 1150°F, as higher temperatures may result in hardening. E410NiMo electrodes are used to weld materials of similar chemical composition in cast and wrought forms. Also used for repair welding of large 410 castings as well as light gauge 405, 410 and 410S stainless steels.
E430-16	74 ksi	58.8 ksi	23 %	E430-16 electrodes should be welded with a 300-450°F preheat and interpass temperature with a post weld heat treatment of 1450-1550°F for four hours; furnace cooled to 1100°F and then either air cooled or water quenched. Heavy sections may require forced cooling or spray quenching through the temperature range from 1050 to 750°F to avoid 885°F embrittlement. E430-16 electrodes are used to weld steels of similar composition for such uses as automobile body moldings and bright trim applications.
E630-16 (17-4 PH)	150.0 ksi	133.8 ksi	10 %	E630-16 weld deposits have excellent mechanical properties with high-strength and hardness. Depending on the weld dimensions and applications, E630-16 can be used in the as-welded condition or in the heat treated condition, or welded plus solution treated plus precipitation hardened condition to obtain higher strength. This electrode offers the combined characteristics of a strong, corrosion resistant, easily machinable weld metal. E630-16 is most commonly used in high-temperature and abrasion resistant environments such as those found in the petrochemical and aerospace industries. Also used to weld ASTM A-564 (17CR-4Ni) and (17CR-7Ni) base metal, and precipitation hardenable steel.
E2553-16	110 ksi	- ksi	15 %	E2553-16's weld metal deposit has a "duplex" microstructure consisting of an austenite-ferrite matrix. This "duplex" weld deposit combines increased tensile strength with improved resistance to pitting, corrosive attack and to stress corrosion cracking. E2553-16 electrode's are used to weld Ferralium® 255 and duplex stainless steels, which contain approximately 25 % chromium.
E2594-16	130 ksi	101 ksi	31 %	Superduplex grade 2594 electrodes provide matching chemistry and mechanical property characteristics to wrought superduplex alloys such as 2507 and Zeron 100 as well as superduplex casting alloys (ASTM A890). The welding wire is overalloyed 2 - 3% in Nickel to provide the optimum ferrite/austenite ratio in the finished weld. This structure results in high tensile/yield strength and superior resistance to SCC and pitting corrosion.

Stainless Steel Flux Cored Wire

AWS Designation	Tensile Strength	Yield Strength	Elongation	Description & Application
E308LT0-1/4 & E308LT1-1/4	83.0 ksi 83.0 ksi	60.0 ksi 60.0 ksi	38 % 38 %	E308L-T1 is a gas-shielded, flux cored, stainless steel electrode with a nominal weld metal composition of 20% chromium, 10% nickel and a maximum carbon content of 0.04%. The low-carbon in this alloy minimizes carbide precipitation and makes it more resistant to intergranular corrosion. E308L-T1 is used to weld 301, 302, 304L, 308 and 308L stainless steel. Also widely used to weld components for the chemical, paper, textile and pharmaceutical industries. Types 321 and 347 may also be welded as long as the service temperature does not exceed 500°F.
E308L-MC Metal Cored	82.6 ksi	57.0 ksi	38 %	E308L-MC is a gas-shielded, metal cored, stainless steel electrode with a weld metal composition of 19.5-22% Chromium, 9-11% Nickel and a maximum of 0.03% carbon. The low-carbon minimizes carbide precipitation and makes it more resistant to intergranular corrosion. 308L-MC produces little or no slag and virtually no spatter, minimizing cleanup. E308L-MC can be used to weld the same grades of stainless steel as 308-MC; in addition, it can be used to weld types 321 and 347 when the service temperature does not exceed 500°F. Designed for use with Ar/1-2% O ₂ or Ar/1-2% CO ₂ shielding gases.
E308HT1-1/4	86.8 ksi	65.4 ksi	44 %	E308HT-1 has a minimum carbon content allowed of 0.04%. E308HT-1 was developed for out-of position welding. This flux cored wire will deposit out-of position welds at substantially higher welding currents than other stainless steel flux cored wires, resulting in a higher deposition rate. The slag is self-peeling and minimizes cleanup. E308HT-1 was formulated for use with 75% Argon/25% CO ₂ shielding gas, with virtually no spatter and slightly higher yield and tensile strength than CO ₂ , however straight CO ₂ may also be used. Mechanical properties and deposit analysis will meet AWS 5.22 specifications with either gas. E308HT-1 is used for welding types 304H and 347H stainless when high-temperature service is required.
309L-T1	85.1 ksi	66.9 ksi	38 %	309L-T1 is a gas-shielded, flux cored, stainless steel electrode for use in all position welding. The maximum carbon content of 0.04% minimizes carbide precipitation and makes the weld metal more resistant to intergranular corrosion. 309L-T1 is utilized in welding refinery and chemical processing equipment as well as furnace and auto exhaust parts. It welds type 309 stainless steel, joins carbon and low alloy steels and welds 304 clad sheets as well as the first layer cladding of carbon steel.
E309LT0-1/4 & E309LT1-1/4	85.5 ksi 86 ksi	62.6 ksi 61.7 ksi	37 % 38 %	E309LT0-1/4 & E309LT1-1/4 are designed for MAG welding of 22% Cr - 12% Ni steel and heat resistant & dissimilar joint such as a stainless steel to carbon steel or low alloy steel. Under layer welding on clad side groove clad stainless steel or carbon steel where stainless steel weld metal is overlaid. <ul style="list-style-type: none"> • E309LT0-1/4 is titania type of flux cored wire for flat & horizontal position welding. • E309LT1-1/4 is titania type of flux cored wire for all position welding. • Recommended shielding gas - 100% CO₂ Gas or 80% Ar + 20% CO₂ gas. E309LT series wires provide stable arc, easier slag removal, less spatter & welding fume than solid wires. The weld metal with optimum ferrite contents in its austenitic structures provides excellent weldability and lower crack susceptibility.
E309L-MC Metal Cored	84.0 ksi	64.2 ksi	35 %	E309L-MC is a gas-shielded, metal cored, stainless steel electrode with a maximum carbon content of 0.03%. The low-carbon minimizes carbide precipitation and makes it more resistant to intergranular corrosion. 309L-MC has a smooth, spray arc transfer and produces little or no slag with virtually no spatter. E309L-MC is used to weld 304 to carbon steel, welding the clad side of 304 clad steels, and welding stainless steel sheet linings to carbon steel shells. It is used for metal cored arc welding with argon/carbon dioxide or argon/oxygen gas blends.

(Continued on next page)

FILLER METALS

AWS Designation	Tensile Strength	Yield Strength	Elongation	Description & Application
E309LMoTi-1/-4	98.6 ksi	81.2 ksi	33 %	E309LMoTi-1/-4 is a titania type of flux cored wire for all-position welding. This product is designed for MAG welding of low-carbon 22% Cr ~12% Ni-Mo stainless steels. <ul style="list-style-type: none"> • Dissimilar joint welds ; of and between high-strength, mild steels and low-alloyed QT-steels, stainless, ferritic Cr- and austenitic Cr-Ni steels, manganese steels. • Cladding ; for the first layer of corrosion resistant weld claddings on ferritic-pearlitic steels in boiler and pressure vessel parts up to fine-grained steel S500N. • Recommended shielding gas - 100% CO2 Gas only. Weld metals contain comparatively much more ferrite in their austenitic, therefore they provide better weldability together with superior heat resistance, and corrosion resistance for Mo-alloyed claddings the product is necessary for the 1st layer.
E316L-M Metal Cored	82.9 ksi	63.1 ksi	37 %	E316L-MC is a gas-shielded, metal cored, stainless steel electrode. This electrodes composition includes 18-22% chromium, 11-14% nickel, 2-3% molybdenum and a maximum of 0.03% carbon. This combination provides a weld metal with increased creep resistance and improves resistance to pitting, carbide precipitation and intergranular corrosion. E316L-MC is designed for use with Ar/1-2% O2 or Ar/1-2% CO2 gases. It is utilized in the pulp and paper industry, chemical and textile processing equipment, furnace parts and in parts exposed to marine environments and.
E316LT0-1/4 & E316LT1-1/4	83.3 ksi 83.8 ksi	61.6 ksi 61.2 ksi	42 % 42 %	E316LT0-1/4 & E316LT1-1/4 are designed for welding of low-carbon 18%Cr ~12%Ni ~ 2% Mo stainless steel. Under layer welding on clad side groove clad stainless steel or carbon steel where stainless steel weld metal is overlaid. <ul style="list-style-type: none"> • E316LT0-1/-4 is titania type of flux cored wire for flat & horizontal position welding. • E316LT1-1/-4 is titania type of flux cored wire for all-position welding. • Recommended shielding gas - 100% CO2 Gas or 80% Ar + 20% CO2 gas. 316LT series wires provide excellent usability with stable arc, less spattering, good bead appearance, better slag removal, and less quantity of welding fume comparable to solid wire. Excellent weldability and increased creep resistance at elevated temperature.
E317LT1-1/4	91.7 ksi	68.8 ksi	34 %	E317LT1-1/4 is recommended for welding type 317 and 317L stainless steel to give a maximum of 0.04% Carbon in the weld deposit. The higher molybdenum content, as compared to type 316L, further reduces susceptibility to pitting corrosion. It was developed for out-of-position welding at substantially higher welding currents than other stainless steel flux cored wires, resulting in a higher deposition rate. The slag is self-peeling and minimizes cleanup. E317LT1-1/4 was formulated for use with 75% Argon/25% CO ² shielding gas to produce a smooth arc with virtually no spatter and slightly higher yield and tensile strengths than CO ² , however, straight CO ² may also be used. The mechanical properties and deposit analysis will meet AWS 5.22 specifications with either gas. 317L-T1 This flux cored wire is used in the pulp and paper industry and in other severe corrosion applications involving sulfuric and sulfurous acids and their salts.
E347Ti-1/4	94.0 ksi	63.0 ksi	35 %	E347Ti-1/4 is a gas-shielded, flux cored, all position stainless steel electrode with a nominal weld metal composition of 19.5% chromium, 10% nickel and 0.5% columbium (niobium). The columbium forms a stable carbide which reduces chromium carbide precipitation and makes weld metal more resistant to intergranular corrosion. E347Ti-1/4 is used with 100% CO2 or a blend of 75-80% Ar/balance CO2. It is utilized in the welding of furnace parts, high-pressure steam piping parts, pressure vessels, chemical tanks and automotive parts. It is also used to weld 321, 347 and 348 stainless steels.
E409-MC Metal Cored	67.0 ksi	50.5 ksi	26 %	E409-MC is a composite metal cored, stainless steel electrode for gas-shielded arc welding. Arc transfer is a smooth spray with virtually no spatter emission. This electrode is stabilized with both niobium (columbium) and titanium. E409-MC is intended for welding ferritic stainless steel sheet and thin gauge material, such as those in exhaust systems for trucks and automobiles. Designed for use with Ar/1-2% O2 shielding gas.
E409Nb	67.0 ksi	50.5 ksi	26 %	E409Nb is a composite metal cored, stainless steel electrode for gas-shielded arc welding. Arc transfer is a smooth spray with minimal spatter; bead appearance is smooth and clean. E409Nb produces a ferritic stainless steel deposit which is ideal for welding thin gauge ferritic stainless in the fabrication of automotive exhaust systems. Typically, these components are manifolds, mufflers, catalytic converters and tubing. The tubular wire characteristics provide better performance on gaps and poor fit up than solid wires.
E2209Ti-1/4	121.0 ksi	98.0 ksi	24 %	E2209Ti-1/4 is a flux cored, all position electrode designed to weld duplex stainless steels of the 22Cr-9Ni-2Mo-N type. The weld deposit has a "duplex" microstructure of austenite and ferrite and normally gives ferrite in the range of 30-60 FN. E2209Ti-1/4 provides excellent notch toughness of 35 ft per pound at -20°F and is designed for use with 100% CO2 or 75-80% Ar/balance CO2 shielding gas. E2209Ti-1/4 is used to weld similar materials in the chemical and fertilizer industry, off-shore pipelines, sour gas lines, etc.

Aluminum Alloys

AWS Designation	Tensile Strength	Yield Strength	Elongation	Description & Application
1100 Welding Wire	13-24 ksi	5-22 ksi	5-35 %	1100 is a 99% aluminum wire that is highly resistant to chemical attack and weathering. It is recommended for welding 1100 and 3003 aluminum sheets, plates and shapes. It is popular in the fields of construction, decoration, metallurgical, pipelines, spinning apparatus.
4043 Welding Wire	20-34 ksi	10-28 ksi	4 - 12 %	4043 is a 5% silicon aluminum filler metal recommended for welding 2014, 3003, 3004, 5052, 6061, and 6101 (in various conditions of heat treatment and 6063 sheets, plates and shapes). (Can Not Be Anodized). Construction of frames, heavy sheet metal, and machine bases. 4043 can also be used for welding castings. 4043 is designed for welding 6xxx series aluminum alloys. It may also be used to weld 2xxx and 3xxx series alloys. <div style="background-color: #f4a460; padding: 5px; text-align: center; margin-top: 5px;">4043 Electrode Color Code - ALUMAZING</div>
ER4047 Aluminum Brazing Rod	20-34 ksi	10-28 ksi	4 - 12 %	ER4047 is a 12% silicon aluminum brazing rod that is recommended for torch brazing or dip or furnace brazing of 1060, 1350, 3003, 5005, 6061, 6063, and 7005. ER4047 produces very clean weld deposits and provides excellent operator appeal. A lower melting point and higher fluidity are two advantages 4047 has over its cousin 4043.
ER5183 Welding Wire	40 - 45 ksi	18-26 ksi	12-16 %	ER5183 is designed to weld high magnesium alloys to meet higher tensile strength requirements. It is used to weld 5083, 6061, 6063, 5086, 7005 and 7039 alloys, for structural applications in marine and cryogenic industries and structural applications where high-strength, high fracture toughness for impact resistance, and exposure to corrosive elements are important.

AWS Designation	Tensile Strength	Yield Strength	Elongation	Description & Application
ER5356 Welding Wire	27-46 ksi	12-30 ksi	10-17 %	ER5356 is a great general purpose filler alloy designed for the welding of 5XXX series alloys when 40,000 psi (276 MPa) tensile strength is not required. ER5356 is a 5% Magnesium aluminum that offers corrosion resistance when exposed to salt water. It is used to weld 5050, 5052, 5083, 5356, 5454, and 5456 base metal.
ER5554 Welding Wire	35 ksi	16 ksi	17 %	ER5554 is intended as a matching filler alloy when welding 5454 base alloys. This combination of alloys does not become sensitive to stress corrosion cracking at elevated temperatures and is used in those applications that may be subjected to temperatures in excess of 150°F. ER5554 is widely used in the manufacture of chemical storage tanks, automotive wheels, over-the-road trailers, and rail tank cars.
ER5556 Welding Wire	45 ksi	23 ksi	14 %	ER5556 offers an excellent combination of corrosion resistance, strength, toughness, workability, and weldability. It is recommended for welding 5083, 5086, 5154, 5254 and 5456 high tensile aluminum alloys.
1300 Arc Welding Electrode	34 ksi	20 ksi	18 %	1300 is an all position 5% silicon aluminum arc welding electrode with exclusive self-lifting slag. It is used for low temperature production and maintenance welding of cast and wrought aluminum sheets, plates, castings and extrusions. 1300 is widely used for tanks, pipes, appliances, refrigeration equipment, irrigation equipment, automobile parts and parts found in the chemical, food, and laundry industries.

Brazing Alloys

AWS Designation	Tensile Strength	Yield Strength	Elongation	Description & Application
Silvaloy 0	N/A	N/A	N/A	Silvaloy 0 is extremely fluid at brazing temperatures and will penetrate joints with very little clearance. Best results are obtained with clearances of .001-.003". Melting of Silvaloy 0 is virtually complete at 1350°F. Best results are obtained when brazing slightly above this temperature. The phosphorus content of Silvaloy 0 acts as a fluxing agent and no flux is necessary when brazing copper-to-copper joints. However, when used with a copper alloy or one of the other brazeable metals, a brazing flux must be used to promote wetting, bonding, and flow throughout the joint. Silvaloy 0 is primarily used for the joining of copper-to-copper on vibration free joints. It is very effective for joining tight fitting copper pipe and tubing, and is also used for the brazing of copper-to-copper alloys, brass-to-bronze.
Silvaloy 5	N/A	N/A	N/A	Silvaloy 5 has good flow and wetting properties on copper, brass, and bronze. The flow point of is 1325°F. Used when gap clearance range is .003" to .006" ideal for larger copper pipe sizes. Silvaloy 5's melting characteristics are such that on the low end of its brazing temperature range it has "sluggish" flow characteristics which enable it to fill gaps better, making it ideal for loose-fitting joints and at the high end of its brazing temperature range, it is very fluid, making it ideal for tight-fitting joints requiring deep penetration. The phosphorous content of Silvaloy 5 acts as a fluxing agent and no flux is necessary when brazing copper-to-copper joints. However, when used with one of the other brazeable metals, a brazing flux must be used to promote wetting, bonding, and flow throughout the joint.
Silvaloy 6F	N/A	N/A	N/A	Silvaloy 6F has been universally accepted by repair and installation contractors because of its moderate flow with good filleting and gap filling characteristic when the joint fit up dimensions are less than ideal. The phosphorous content of Silvaloy 6F acts as a fluxing agent and no flux is necessary when brazing copper-to-copper joints. However, when used with one of the other brazeable metals, a brazing flux must be used to promote wetting, bonding, and flow throughout the joint. Silvaloy 6F is used for the brazing of copper and copper alloys, brass, and bronze. It should not be used on ferrous metals or alloys containing more than 10% nickel due to the formation of brittle intermetallic phosphide compounds.
Silvaloy 15	N/A	N/A	N/A	Silvaloy 15 has more ductility and better electrical conductivity than the lower silver content phos-coppers. It has good flow and wetting properties on copper, brass and bronze. The phosphorus content acts as a fluxing agent and no flux is necessary when brazing copper to copper joints. However, when used with a copper alloy or one of the other brazeable metals, a brazing flux must be used to promote wetting, bonding and flow throughout the joint. Silvaloy 15 has the most "sluggish" flow characteristics, of the phos-copper filler metals. This enables it to fill gaps better. Melting of Silvaloy 15 is virtually complete at 1300°F even though the liquid is not yet reached. Best results are obtained when brazing slightly above this temperature. Silvaloy 15 is used for the brazing of copper and copper alloys, brass and bronze. It is very effective for joining pipe and tubing and is widely used for electrical work.
Silvaloy 50	N/A	N/A	N/A	Silvaloy 50 is one of the lower melting brazing alloys composed of silver, copper, zinc and cadmium. It has wide acceptance by industrial users, as well as being included in Federal and Military specifications on brazing filler metals or alloys. It has a narrow melting range which is not apparent in most brazing operations, making it flow freely through a capillary. Silvaloy 50's typical applications are the joining of ferrous, nonferrous and dissimilar metals and alloys with close joint clearances. It is suitable for use on most metals except aluminum and magnesium. It is mainly used for joining steel, stainless steel, copper, copper alloys, nickel, nickel alloys or combinations of these metals. Similar to Silvaloy 45 properties with narrower melt range, used on same base metals.
Silvaloy 45	N/A	N/A	N/A	Silvaloy 45 is the lowest melting brazing alloy available composed of silver, copper, zinc and cadmium. It is suitable for use on most metals except aluminum and magnesium. It is used for joining steel, stainless steel, copper, copper alloys, nickel, nickel alloys or combinations of these metals. It has wide acceptance by industrial users, as well as being included in Federal and military specifications on brazing filler metals or alloys. It has a narrow melting range which is not apparent in most brazing operations, making it flow freely through a capillary. Silvaloy 45's typical applications are the joining of ferrous, nonferrous and dissimilar metals. Silvaloy 45 should be used for close joint clearances (0.000-0.003in).
Silvaloy 50N	N/A	N/A	N/A	Silvaloy 50N is a modification of Silvaloy® 50. It was originally introduced because of somewhat better corrosion resistance than Silvaloy 50 for certain conditions, and is still used for such purposes. When melting, Silvaloy 50N passes from the solid state to a mushy or plastic range and progressively to a liquid. The largest portion of Silvaloy 50N melts in the upper section of its temperature range. Therefore, the alloy has a good body while in the plastic range and is suitable for building fillets or bridging large gaps. Late melting of the major portion of the alloy also helps minimize any separation of the solid and liquid portions by liquation during melting. It has proven successful on many marine applications and for dairy equipment which must withstand strong cleaning solutions. The 3% nickel content of this alloy also improves its wetting of stainless steel and tungsten, or molybdenum carbide tool tips. Silvaloy 50N the largest use of this solder is for attaching carbide cutting tips to tool shanks.
Silvaloy A-45	N/A	N/A	N/A	Silvaloy A-45 is a good general purpose alloy often used when cadmium must be avoided such as in the dairy and food industries. Silvaloy A-45's typical applications are the joining of ferrous, nonferrous and dissimilar metals. It is used for brazing in the electrical industry and for brazing brass parts such as ships, piping, band instruments and lamps. Excellent replacement to cadmium containing alloys. Broad application in furnace brazing.

(Continued on next page)

Bronze Alloys

AWS Designation	Tensile Strength	Yield Strength	Elongation	Description & Application
1400 Phos-Bronze	50 ksi	N/A	18 %	1400 is an all position Phos-Bronze electrode used for joining copper base alloys to themselves and to stainless steels and cast irons. It provides a good color match on bronze and will work harden. Weld deposits are ductile, strong, and machinable. It offers corrosion resistance to salt water and chemicals. Used for overlays on pumps, shafts, impellers and propeller blades, and for building up bearing journals and frictional wear surfaces on heavier sections, galvanized iron, and ornamental iron.
Aluminum Bronze A2 Coated	77 ksi	35 ksi	27 %	A2 is very versatile for joining aluminum bronze of similar composition, silicon and manganese bronze, high-strength copper-zinc alloys, some copper-nickel alloys, ferrous metals and dissimilar metals. Dissimilar applications include aluminum bronze to steel and copper to steel. It is also used for building up or overlaying metal for wear and corrosion resistant surfaces. Used for marine maintenance and repair welding of ship propellers, pump housings, rigging jacks, piston heads, bearings and many overlay or surfacing applications.
Deoxidized Copper	29 ksi	8 ksi	29 %	Deoxidized Copper provides dense, high quality deposits with relatively high electrical conductivity for use in joining and overlay with inert gas processes. Used to fabricate deoxidized copper, repair weld copper castings, to weld galvanized steel and deoxidized copper to mild steel where high-strength joints are not required. Used for billet molds, conductor rolls, heater elements, copper sculptures, bus bars, copper connectors, and steel mill electrode holders.
Techniwear	50 ksi	N/A	65 %	Silicon Bronze is a copper based filler metal that contains 3% silicon and trace amounts of manganese, tin and zinc. The oxyacetylene gas flame should be slightly oxidizing. Keep the weld puddle small in order to promote fast solidification and minimize cracking. A high boric acid flux should be used both before and during welding. Preheat is NOT recommended. Used primarily for oxyacetylene welding of copper, copper-silicon and copper-zinc metals to themselves and to steel. It is excellent for plain or galvanized steel sheet metal as well as other coated steels, and surfacing areas that are subjected to corrosion.
Aluminum Bronze A1	68 ksi	28 ksi	47 %	A1 is an iron free alloy used primarily to overlay bearings and wear-resistant surfaces that require a 125 BHN hardness and to resist corrosion, especially from salt water, metal salts and acids in varying concentrations and temperatures. It is not recommended for joining since the deposit has a tendency to be hot short. For welding tube sheets, valve seats, pickling hooks, impellers, in chemical plants, and pulp mills.
Aluminum Bronze A2	60 ksi	N/A	N/A	Aluminum Bronze A2 is an iron-bearing aluminum bronze and is generally used for joining aluminum bronzes of similar composition, manganese, silicon bronzes, some copper-nickel alloys, ferrous metals and dissimilar metals. The most common dissimilar metal combinations are aluminum bronze to steel and copper to steel. It is used to provide wear- and corrosion-resistant surfaces.
40	75 ksi	N/A	N/A	40 manganese-nickel-aluminum bronze filler metal used for joining and repairing of cast or wrought base metals of similar composition. This filler metal may also be used for surfacing applications where high resistance to corrosion, erosion, or cavitation is required.
46	72 ksi	N/A	N/A	46 nickel-aluminum bronze is used for joining and repairing of cast or wrought nickel-aluminum bronze base metals.
Phos-Bronze A	35 ksi	N/A	N/A	Phosphorous Bronze A contains about 5 % tin and up to 0.35 % phosphorous added as a deoxidizer. Tin increases wear resistance of the weld metal and slows the rate of solidification by broadening the temperature differential between the liquids and solids. This slower solidification increases the tendency to hot shortness. To minimize this effect, the weld pool should be kept small and welding time as short as possible. Phosphorous Bronze A can be used to weld bronze and brass. It also can be used to weld copper if the presence of tin in the weld is not objectionable.
Low Fuming Bronze	63 ksi	N/A	25 %	Low Fuming Bronze has a high tensile strength and good ductility. It is a machinable brazing alloy used on steels, copper alloys, nickel alloys, and stainless steel. The weld deposit freezes rapidly from fluid to a plastic state. Preheat is required for some applications and a brazing flux is recommended. Low Fuming Bronze is available in bare and flux-coated. The weld deposits are non-porous for leak proof joints for water, oil and gas lines.
Nickel Silver	70 ksi	N/A	25 %	Nickel Silver is a low fuming, cadmium-free bronze. It is an excellent replacement for high cost silver brazing alloys when higher brazing temperatures are acceptable. The weld deposits of Nickel Silver have very high tensile strength, good ductility and excellent corrosion resistance and are also machinable and work-harden when put into service. Preheating may be desired for some applications. A neutral or slightly oxidizing flame is recommended. Used for brazing Tungsten carbides, copper alloys, nickel alloys, stainless steels & carbon steels, brazing or oxyacetylene welding of steel or cast iron where good color match is desired and building-up or overlaying worn parts such as gear teeth, bearings and valve seats.

Nickel Alloy Bare Wire

AWS Designation	Tensile Strength	Yield Strength	Elongation	Description & Application
Alloy 55	89.5 ksi	62 ksi	35 %	Alloy 55 welds are moderately hard and require carbide tipped tools for machining. A preheat and interpass temperature of not less than 350°F (175°C) is required during welding, without which the weld and heat affected zones could develop cracks. The weld metal of 55 is harder than that of 99. Alloy 55 is used for TIG and MIG welding of cast iron. This filler metal is extensively employed to overlay the cast iron rolls and is also used for the repair of castings.
Alloy 99	66.5 ksi	36 ksi	40 %	Alloy 99 welds are easily machinable, however, dilution from the casting influences the mechanical properties of the metal. A preheat and interpass temperature of 350°F (175°C) minimum is recommended during welding. Alloy 99 is used for TIG and MIG welding of cast iron. This wire is extensively employed to repair gray iron castings. It can also be used for overlay and build-up.
Alloy 59	110 ksi	N/A	25 %	Alloy 59 is a Ni-Cr-Mo alloy with an extra low-carbon and silicon content. This wire has excellent corrosion resistance and high mechanical strength. Alloy 59 is used to weld low-carbon Ni-Cr-Mo alloys to themselves and for dissimilar welding of alloys such as C-276, 22, 625 and other high alloy steels such as 6Mo stainless, 825, and even common grades of stainless steels. Some base metals that Alloy 59 are used on are ASTM and ASME B and SB 574, 575, 619, 622, and 626.
Alloy 60	76.5 ksi	52.5 ksi	34 %	Alloy 60 is used for TIG, or MIG welding of nickel copper alloys (ASTM B127, B163, B164, and B165 UNS Number N04400). This filler metal can be used for MIG overlay on steel after a first layer with nickel 208 (Filler Metal 61). Alloy 60 is widely used in marine applications because of its good resistance to the corrosive effects of seawater and brackish waters. Dissimilar welding applications include joining Monel alloys to Nickel 200 and copper-nickel alloys.

(Continued on next page)

AWS Designation	Tensile Strength	Yield Strength	Elongation	Description & Application
Alloy 61	66.5 ksi	38 ksi	28 %	Alloy 61 is used for TIG, MIG, and SAW welding of nickel 200 or 201. Alloy 61 is used for overlaying on steel, repairing cast iron castings and for dissimilar joints between nickel or nickel alloys to stainless or ferritic steels.
Alloy 62	80 ksi	79 ksi	30 %	Alloy 62 is used for welding nickel-chromium iron alloy (600) to itself using the GTAW, GMAW, SAW, and PAW processes. The higher niobium content of Alloy 62 is intended to minimize cracking where high welding stresses are encountered, as in thick-section base metal up to 2".
Alloy 65	88.5 ksi	61 ksi	34 %	Alloy 65 is used for TIG, MIG, and SAW welding of Ni-Fe-Cr-Mo-Cu alloys such as alloy 825. The weld metal is highly resistant to corrosion particularly in reducing chemicals such as sulphuric and phosphoric acids. Alloy 65 can be used to overlay cladding where similar chemical composition is required.
Alloy 67	53 ksi	21 ksi	32 %	Alloy 67 is used for TIG, MIG, and oxy-fuel welding of 70/30, 80/20, and 90/10 copper-nickel alloys. This filler metal can be used for MIG overlay on steel after a first layer with Nickel 208 (Filler Metal 61). Dissimilar-welding applications for Alloy 67 include joining copper-nickel alloys to Nickel 200 or nickel-copper alloys.
Alloy 82	53 ksi	21 ksi	32 %	Alloy 82 is used for TIG, MIG, and SAW welding of base materials such as ASTM B163, B166, B167, and B168 alloys which have UNS Number N0660. Alloy 82 is one of the most used nickel alloys whose applications range from cryogenic to high-temperatures. This filler metal can also be used for dissimilar welding applications between various nickel alloys and stainless or carbon steels, as well as for overlaying.
Alloy 92	80 ksi	80 ksi	30 %	Alloy 92 is used for cladding steel with nickel-chromium-iron weld metal and for joining steel to nickel-base alloys using the GTAW, GMAW, SAW, and PAW processes. The weld metal will age harden on heat treatment.
Alloy 601	90 ksi	90 ksi	25 %	Alloy 601 is used for welding nickel-chromium-iron-aluminum alloy (601) to itself and to other high-temperature compositions using the GTAW process. It is used for severe applications where the exposure temperature can exceed 2100°F (1150°).
Alloy 617	94 ksi	94 ksi	42 %	Alloy 617 is used for welding nickel-chromium-cobalt-molybdenum alloy to itself using the GTAW and GMAW processes. Alloy 617 can also be used for welding joints of dissimilar steels and for elevated temperature service.
Alloy 622	115 ksi	82 ksi	38 %	Alloy 622 is an alloy of nickel with chromium molybdenum and tungsten as principal alloying elements. 622 offers excellent corrosion resistance in oxidizing as well as reducing media in a wide variety of chemical process environments. It offers an outstanding resistance to stress corrosion cracking, pitting, and crevice corrosion. Alloy 622 is used to weld alloys of similar composition as well as dissimilar joints between nickel-chromium-molybdenum alloys and stainless or carbon or low alloy steels. It can also be used for cladded overlay as well as spraying applications.
Alloy 625	114.5 ksi	85 ksi	35 %	Alloy 625 is used for GMAW, GTAW and SAW of Ni-Cr-Mo alloys. This filler metal may be used for cladding and welding dissimilar base metals such as Ni-Cr-Mo alloys to stainless and carbon steels. Alloy 625 provides excellent resistance to oxidizing and reducing environments and good stress, pitting and crevice corrosion resistance because of this alloys high Mo content.
Alloy 718	165 ksi	165 ksi	25 %	Alloy 718 is used for welding nickel-chromium-niobium-molybdenum alloy (718) to itself using the GTAW processes. Alloy 718 is a precipitation hardenable nickel-base alloy designed to display exceptionally high yield, tensile and creep-rupture properties at temperatures up to 1300°F (704°C). The sluggish age-hardening response of AFM 718 permits annealing and welding without spontaneous hardening during heating and cooling. Alloy 718 has excellent weldability when compared to the nickel-base superalloys hardened by aluminum and titanium.
Alloy C276	105 ksi	81 ksi	40 %	Alloy C276 is used for GMAW, GTAW and SAW processes of nickel alloys with Cr and Mo. This grade may also be used for welding nickel alloys to dissimilar base metals such as stainless steel or low alloy steels. Alloy C276 is also used for overlay cladding of low alloy or carbon steel to provide general corrosion resistance and, due to the high-molybdenum content, a strong resistance to stress corrosion cracking, pitting and crevice corrosion.
Alloy W	105 ksi	81 ksi	40 %	Alloy W is a superalloy most commonly used for joining dissimilar combinations of cobalt and nickel base alloys used in high-temperature service applications. The weld deposit exhibits good mechanical properties up to 1800°F, however it does exhibit poor oxidation resistance above 1400°F and it should not be used for service applications in excess of 750 hours. Alloy W displays excellent dissimilar welding characteristics, and is widely used in the gas turbine, aerospace, and chemical process industries.
Alloy X	95 ksi	N/A	N/A	Alloy X is a solid-solution-strengthened superalloy that combines very good high-temperature strength with very good resistance to oxidizing environments up to about 2000°F (1095°C), and good carburization resistance. Alloy X may be cold-formed or hot-formed by various techniques, and is readily weldable by most standard methods. Alloy X is one of the most widely used materials for fabrication of forged parts in gas turbine engines, and is also used in chemical and petrochemical plants, power plants and industrial heating applications.

Nickel Alloy Coated Electrodes

AWS Designation	Tensile Strength	Yield Strength	Elongation	Description & Application
E55	84 ksi	59.5 ksi	8 %	E55 welds are moderately hard and require carbide tipped tools for machining. A preheat and interpass temperature of not less than 350°F (175°C) is required during welding. E55 is used for the repair of castings, welding of cast irons to themselves as well as for joining cast irons to mild steels.
E99	72 ksi	56.5 ksi	5 %	E99 welds are quite machinable. A preheat and interpass temperature of not less than 350°F is recommended during welding. E99 is designed for welding of gray iron castings to themselves as well as joining them to mild steels or stainless steels. It is also used extensively to repair castings.
E112	114.5 ksi	89.5 ksi	34 %	E112 is a coated electrode which is used to weld nickel-chromium-molybdenum alloys. It is also used extensively in overlay cladding where similar chemical composition is required on the clad side. E112's applications include dissimilar joints between nickel-chromium-molybdenum alloys to either stainless steels, carbon, or low alloy steels. These electrodes are used in applications where the temperature ranges from cryogenic up to 1800°F.
E117	110 ksi	87 ksi	26 %	The weld metal of E117 provides optimum strength and oxidation resistance above 1500°F up to 2100°F, especially when welding on base metals of Ni-Fe-Cr alloys. E117 is used for welding of Ni-Cr-Co-Mo alloys (UNS number N06617). This electrode can also be used for overlay cladding where similar alloy is required.

(Continued on next page)

FILLER METALS

AWS Designation	Tensile Strength	Yield Strength	Elongation	Description & Application
E122	110 ksi	87 ksi	26 %	E122 is used for welding nickel chromium-molybdenum alloys, for the welding of the clad side of joints in steel clad with nickel chromium-molybdenum alloy, to steel and to their nickel-base alloys; and for joining nickel chromium-molybdenum alloys. Typical specifications for the nickel-chromium molybdenum base metals have UNS Number N06022.
E141	64.5 ksi	58.5 ksi	26 %	E141 weld metal has excellent corrosion resistance to caustic alkalies such as caustic soda and caustic potash. E141 is used for welding of cast and wrought forms of commercially pure nickel. These electrodes can also be used for surfacing as well as dissimilar welding between nickel and steel or stainless steel.
E182	64.5 ksi	58.5 ksi	26 %	E182 electrodes are used for welding of nickel-chromium-iron alloys to themselves, and for dissimilar welding between nickel-chromium-iron alloys and steels or stainless steels. High manganese of this weld deposit reduces the possibility of micro fissures. High manganese reduces creep strength, which limits its usage up to 900°F. E182 applications include surfacing as well as clad-side welding.
E187	54.5 ksi	37.5 ksi	28 %	E187 is a copper-nickel, all-position electrode for shielded metal arc welding of wrought or cast alloys of similar composition as well as 80 Cu + 20 Ni and 90 Cu + 10 Ni alloys. It is also used for the clad side of copper-nickel clad steels. E187 filler metal is widely used in marine applications because of its good resistance to the corrosive effects of sea water.
E190	75.5 ksi	52 ksi	39 %	E190 is used for welding materials of nickel-copper alloys to themselves (such as ASTM, B126, B163, B164, B165 all of which have UNS Number N04400). 190 can also be used for overlay welding as well as for welding of clad steels where nickel-copper surfacing is required. Dissimilar welding applications include joining nickel 200 and copper-nickel alloys. E190 filler metal is widely used in marine applications due to its excellent resistance to the corrosive effects of seawater.
Weld A	75.5 ksi	52 ksi	39 %	Weld A electrodes are used for welding of nickel-chromium-iron alloys to themselves as well as for dissimilar welding between various nickel alloys and carbon or stainless steels. These electrodes have wide applications ranging from cryogenic temperatures up to 1500°F. These electrodes can also be used for overlay cladding where similar alloy is needed.
C276	106 ksi	78.5 ksi	39 %	C276's high-molybdenum content offers excellent resistance to stress corrosion cracking, pitting and crevice corrosion and used for overlay cladding to withstand process corrosion. C276 weld metal is capable of withstanding cryogenic temperatures. C276 is used for welding materials of similar composition. This low-carbon nickel-chromium-molybdenum filler metal can also be used for dissimilar welding between nickel base alloys and stainless steels, or low alloy steels.
X	95 ksi	N/A	N/A	Alloy X is a solid-solution-strengthened superalloy that combines very good high-temperature strength with very good resistance to oxidizing environments up to about 2000°F (1095°C), and good carburization resistance. Alloy X may be cold formed or hot-formed by various techniques, and is readily weldable by most standard methods. Alloy X is one of the most widely used materials for fabrication of forged parts in gas turbine engines, and is also used in chemical and petrochemical plant, power plant and industrial heating applications.
82-T1	89 ksi	58 ksi	26 %	82-T1 is a gas shielded flux cored wire that can be used for welding in all positions using 100% CO ₂ or Argon/ CO ₂ mixtures. The wire possesses excellent weldability and can be used in a wide variety of similar and dissimilar welding and cladding applications. Typical applications include joining Ni-Cr-Fe alloys, clad side of joints in steels clad with Ni-Cr-Fe weld metal, surfacing steel with Ni-Cr-Fe weld metal and joining Inconel® 600, 601 and Incoloy® 800 to themselves or to stainless and carbon steels.
622-T1	115 ksi	82 ksi	34 %	622-T1 is a gas shielded flux cored wire for welding in all positions using 100% CO ₂ or Argon/CO ₂ mixtures. The wire has excellent weldability and can be used in a wide variety of similar and dissimilar welding and cladding applications. 622-T1 applications include joining Ni-Cr-Mo alloys, clad side of joints in steels clad with Ni-Cr-Mo weld metal, surfacing steel with Ni-Cr-Mo weld metal and joining high-molybdenum - high nitrogen containing stainless steels.
625-T1	115 ksi	82 ksi	34 %	625-T1 is a gas shielded flux cored wire used for welding in all positions using 100% CO ₂ or Argon/CO ₂ mixtures. The wire has excellent weldability and can be used in a wide variety of similar and dissimilar welding and cladding applications. Some applications for 625-T1 include joining Ni-Cr-Mo alloys, clad side of joints in steels clad with Ni-Cr-Mo weld metal, surfacing steel with Ni-Cr-Mo weld metal, joining steels to nickel based alloys and joining 9% nickel steel for cryogenic applications.
C276-T1	110 ksi	75 ksi	37 %	C276-T1 is a gas shielded flux cored wire that can be used for welding in all positions using 100% CO ₂ or Argon/CO ₂ mixtures. Typical specifications for Ni-Cr-Mo base metals are ASTM B574, B575, B619, B622 and B626, all of which have UNS# N10276. C276-T1 possesses excellent weldability and is used in welding low-carbon Ni-Cr-Mo alloys to other nickel base alloys.

Cobalt Alloys

AWS Designation	Abrasion Resistance	Impact Resistance	Corrosion Resistance	Hardness	Hot Hardness	Description & Application
1 - Welding Rod	Excellent	Fair	Good	HRC 48-56	Very Good	Bare cobalt based alloy containing chromium and tungsten. This rod has the highest hardness of the standard cobalt alloys which gives it an excellent resistance to abrasion, heat and corrosion. It can be machined or ground with difficulty using carbide tools. This rod bonds well with stainless and other weldable grade steels. Used for mixer seals and rotors, hydro pulper disc segments, chemical valve balls and seats, oil drilling tools and carbon scrapers.
6 - Welding Rod	Very Good	Very Good	Good	HRC 38-46	Up to 1200°F	This rod provides resistance to many forms of chemical and mechanical degradation over a wide temperature range. It is the most versatile and widely used cobalt alloy, with a good balance of abrasion and impact resistance. Particular attributes are its outstanding anti-galling properties, high-temperature hardness and high resistance to cavitation erosion that results in its wide use as a valve seat material. It bonds well to all weldable grade steels and stainless. Used for zinc tanks, trimmer dies, forging dies, guide rolls, diesel engine valves, trunnions, chemical and steam valve trim, bearing and bushing areas and plastic extrusion screws.
12 - Welding Rod	Excellent	Good	Good	HRC 44-50	Excellent	This 12 Bare rod is slightly harder than Bare rod 6 with better abrasive and metal-to-metal wear resistance. It produces a high hardness cobalt-chromium deposit. The chromium carbides contained in the deposit provide excellent resistance to many forms of chemical and mechanical degradation, including galling. It bonds well with all weldable steels, including stainless. Used for high-pressure valve, shear edge, saw teeth, etc.

(Continued on next page)

AWS Designation	Abrasion Resistance	Impact Resistance	Corrosion Resistance	Hardness	Hot Hardness	Description & Application
21 - Welding Rod	Fair	Excellent	Good	HRC 40-45	Excellent	The 21 Bare rod deposits a low-carbon austenitic cobalt type alloy with excellent work hardenability, high-temperature strength, and impact resistance. The least crack sensitive of all the cobalt based alloys. Resistance to galling corrosion and cavitation erosion. This alloy, a low-carbon, molybdenum strengthened cobalt-chromium alloy will work harden to Rc 45+ with excellent impact and metal to metal wear qualities, especially at high-temperatures. Used for overlays in hot extrusion and forging dies, trimmers, punches and hot shear blades, valve trim on steam and fluid control valve bodies and seats.
1 Coated Coated Electrodes	Excellent	Fair	Good	HRC 48-56	Very Good	Flux-coated cobalt based alloy containing chromium and tungsten. This rod has the highest hardness of the standard cobalt alloys which gives it an excellent resistance to abrasion, heat and corrosion. It can be machined or ground with difficulty using carbide tools. This rod bonds well with stainless and other welding grade steels. Used for mixer seals and rotors, hydro pulper disc segments, chemical valve balls and seats, oil drilling tools and carbon scrapers.
6 Coated Coated Electrodes	Very Good	Very Good	Good	HRC 38-46	Up to 1200°F	This flux-coated cobalt based electrode provides resistance to many forms of chemical and mechanical degradation over a wide temperature range. It is the most versatile and widely used cobalt alloy, with a good balance of abrasion and impact resistance. Particular attributes are its outstanding anti-galling properties, high-temperature hardness and high resistance to cavitation erosion. It bonds well to all weldable grade steels and stainless. Used for zinc tanks, trimmer dies, forging dies, guide rolls, diesel engine valves, trunnions, chemical and steam valve trim, bearing and bushing areas and plastic extrusion screws.
12 Coated Coated Electrodes	Excellent	Good	Good	HRC 44-50	Excellent	This flux-coated cobalt based electrode is slightly harder than Coated 6 with better abrasive wear, good impact resistance, and metal-to-metal wear resistance. It produces a high hardness cobalt-chromium deposit. Chromium carbides contained in the deposit provide excellent resistance to many forms of chemical and mechanical degradation, including galling. It bonds well with all weldable steels, including stainless. Used for high-pressure valve, shear edge, saw teeth, etc.
21 Coated Coated Electrodes	Fair	Excellent	Good	HRC 40-45	Excellent	The 21 coated electrode deposits a low-carbon austenitic type cobalt alloy with excellent work hardenability, high-temperature strength, and impact resistance. The least crack sensitive of all the cobalt based alloys. Resistance to galling corrosion and cavitation erosion. This low-carbon, molybdenum strengthened, cobalt-chromium alloy provides good strength and ductility, as well as excellent impact and metal to metal wear qualities, especially at temperatures to 1600°F. Used for overlays in hot extrusion and forging dies, trimmers, punches and hot shear blades, valve trim on steam and fluid control valve bodies and seats.
1M Welding Wire	Excellent	Fair	Good	HRC 48-56	Very Good	1M is the tubular wire version of the highest hardness standard cobalt alloy which gives it an excellent resistance to abrasion, heat and corrosion. It can be machined or ground with difficulty using carbide tools. This rod bonds well with stainless and other welding grade steels. Used for mixer rotors, hydro pulper disc segments, screw components, cross heads, soaking bit-tong bits, pump sleeves & pumps.
6M Welding Wire	Very Good	Very Good	Good	HRC 38-46	Up to 1200°F	6M is the tubular wire version of a cobalt alloy that provides resistance to many forms of chemical and mechanical degradation over a wide temperature range. It is the most versatile and widely used cobalt alloy, with a good balance of abrasion and impact resistance. Particular attributes are its outstanding anti-galling properties, high-temperature hardness and high resistance to cavitation erosion. It bonds well to all weldable grade steels and stainless. Used for zinc tanks, trimmer dies, forging dies, guide rolls, diesel engine valves, trunnions, chemical and steam valve trim, bearing and bushing areas and plastic extrusion screws.
12M Welding Wire	Excellent	Good	Good	HRC 44-50	Excellent	12M is the tubular wire version of a cobalt alloy that is slightly harder than 6M with better abrasive and metal-to-metal wear resistance. It produces a high hardness cobalt-chromium deposit for high-temperature applications. The chromium carbides contained in the deposit provide excellent resistance to many forms of chemical and mechanical degradation, including galling. It bonds well with all weldable steels, including stainless. Used for high-pressure valve, shear edge, saw teeth, etc.
21M Welding Wire	Fair	Excellent	Good	HRC 40-45	Excellent	21M is the tubular wire version of a cobalt alloy that deposits a low-carbon austenitic cobalt type alloy with excellent work hardenability, high-temperature strength, and impact resistance. The least crack sensitive of all the cobalt based alloys. Resistance to galling corrosion and cavitation erosion. This low-carbon, molybdenum strengthened cobalt-chromium alloy will have excellent impact and metal to metal wear qualities up to 2100°F. Bonds well to all weldable steels, including stainless. Used for overlays in hot extrusion and forging dies, trimmers, punches and hot shear blades, valve trim on steam and fluid control valve bodies and seats.

Titanium and Zirconium Alloys

AWS Designation	Tensile Strength	Yield Strength	Elongation	Description & Application
ERTi-1	35.0 ksi	25.0 ksi	24 %	ERTi-1 is the lowest strength unalloyed, or commercially pure titanium available and is extremely reactive above 1000°F and extra precaution must be taken to have a successful weld. It can be welded by the GTAW, GMAW and plasma arc process. ERTi-1 is used in applications where ductility is most important such as explosive cladding, expanded metal, and deep drawing applications.
ERTi-2	50.0 ksi	40.0 ksi	20 %	ERTi-2 is the "workhorse" of titaniums in the commercially pure titaniums available. As with all titanium alloys ERTi-1 is extremely reactive above 1000°F and extra precaution must be taken to have a successful weld. It can be welded by the GTAW, GMAW and plasma arc process. ERTi-2 is usually used on pressure vessels, pipes, columns, tanks, shafts, valves, and fittings.
ERTi-5	130.0 ksi	120.0 ksi	10 %	ERTi-5 is also known as 6-4 titanium and is the most common and widely used titanium alloy due to its relatively low cost and easy availability. ERTi-5 can be heat treated to a higher strength or toughness making the weldability good. The corrosion resistance is comparable to ERTi-2 and can be welded by the GTAW, GMAW and plasma arc processes. ERTi-5 is used in aircraft components such as landing gear, wing soars, and compressor blades.
ERTi-7	N/A	N/A	N/A	ERTi-7 (Grade 7) has the same mechanical properties as ERTi-2 (Grade 2). The 0.12 wt % palladium addition improves corrosion performance under mildly reducing conditions or where crevice or under-deposit corrosion is a problem. ERTi-7 (Grade 7) can be considered for welding ERTi-2 (Grade 2) or 16 where improved corrosion performance is desired. This alloy extends the use of titanium into mildly reducing media, to much higher chloride levels, or where the environment fluctuates between oxidizing and reducing.

(Continued on next page)

AWS Designation	Tensile Strength	Yield Strength	Elongation	Description & Application
ERTi-23	N/A	N/A	N/A	ERTi-23 (Grade 23, Ti 6Al-4V) is comparable in chemical composition to Grade 5, but slightly lower aluminum and lower levels of oxygen and other interstitial elements improve fabricability, weldability, and toughness. ERTi-23 (Grade 23) is used in many high-strength industrial applications such as shafts where very high-strength, but better toughness and fabricability than Grade 5 is desired. This grade is often specified for marine and offshore energy production components that are exposed to low temperature seawater due to higher fracture toughness values than Grade 5. With special processing, this alloy can develop high fracture toughness. Primary uses are in surgical implants, cryogenic vessels, and airframe components.
ZR 702	55.0 ksi	30.0 ksi	16 %	ZR 702 has excellent corrosion resistance to many chemical solutions as well as excellent resistance to corrosive attack in most organic and mineral acids, strong alkalis, and some molten salts. ZR 702 can be machined, welded and fabricated using the same equipment and processes used in the fabrication of stainless steel, nickel-based alloys and titanium. ZR 702 is most widely used in the chemical processing industry that require alternate contact with strong acids and alkalis. It is used to weld heat exchangers, stripper columns, reactor vessels, corrosive media piping, pumps, and valves. ZR 702 cannot be welded directly to most other structural metals, the exceptions are titanium, vanadium and niobium.

Aerospace Alloys

Aluminum Alloy Filler Metals		
AMS Spec.	Alloy	Nominal Chemical Composition
4180	1100	99.0 Al
4181	4008 (A356.0)	7.0Si 0.38Mg 0.10Ti
4184	4145	10Si 4.0Cu
4185	4047	12Si
4190	4043	5.2Si
4191	2319	6.3Cu 0.30Mn 0.18Zr 0.15Ti 0.10V
4233	201.0	4.5Cu 0.70Ag 0.30Mn 0.25Mg 0.25Ti
4244	206.0	4.6Cu 0.35Mn 0.25Mg 0.22Ti
4245	355.0	5.0Si 1.2Cu 0.50Mg
4246	357.0	7.0Si 0.52Mg

Silver Brazing Filler Metals		
AMS Spec.	Alloy	Nominal Chemical Composition
4761	BAG-34	38.0Ag 32.0Cu 28.0Zn 2.0Sn
4763	BAG-7	56.0Ag 22.0Cu 17.0Zn 5.05 Sn
4765	BAG-13a	56.0Ag 42.0Cu 2.0Ni
4766	BAG-23	85.0Ag 15.0Mn
4767	BAG-19	92.5Ag 7.2Cu 0.22Li
4768	BAG-2	35.0Ag 26.0Cu 21.0Zn 15.0Cu
4769	BAG-1	45.0Ag 24.0Cd 16.0Zn 15.0Cu
4770	BAG-1a	50.0Ag 18.0Cd 16.5Zn 15.5Cu
4771	BAG-3	50.0Ag 16.0Cd 15.5Zn 15.5Cu 3.0Ni
4772	BAG-13	54.0Ag 40.0Cu 5.0Zn 1.0Ni
4773	BAG-18	60.0Ag 30.0Cu 10.0Sn
4774	BAG-21	63.0Ag 28.5Cu 6.0Sn 2.5Ni

Magnesium Alloy Filler Metals		
AMS Spec.	Alloy	Nominal Chemical Composition
4395	AZ92A	9.0Al 2.0Zn
4396	EZ33A	3.3Ce 2.5Zn 0.72Zr
4418	QE22A	2.5Ag 2.1Di 0.70Zr

Nickel Base Brazing Filler Metals		
AMS Spec.	Alloy	Nominal Chemical Composition
4775	BNi-1	73.0Ni 4.5Si 14.0Cr 3.1B 4.5Fe 0.75C
4777	BNi-2	82.0Ni 4.5Si 7.0Cr 3.1B 3.0Fe

Titanium Alloy Filler Metals		
AMS Spec.	Alloy	Nominal Chemical Composition
4951	CP-Ti	0.08C 0.180 0.005H 0.05N 0.20Fe Ti Bal
4952	6-2-4-2	6.0Al 2.0Sn 4.0Zr 2.0Mo
4953	5Al 2.5Sn	5.0 Al-2.5 Sn
4954	6Al-4V	0.05C 0.120 0.015H 0.03N 6.75Al 4.50V 0.30Fe Ti Bal
4955	8-1-1	0.08C 0.120 0.01H 0.05N 8.0Al 1.0Mo 1.0V Ti Bal
4956	6Al-4V(ELI)	0.03C 0.080 0.005H 0.012N 6.75Al 4.5V 0.15Fe 0.10Mn Ti Bal

Titanium Alloy Filler Metals		
AMS Spec.	Alloy	Nominal Chemical Composition
6452	4140VM	0.95Cr 0.20Mo (0.38- 0.43C)
6453	Hy Tuf	0.30Cr 1.8Ni 0.40Mo (0.23-0.28C)
6456	4340VM	0.80Cr 1.8Ni 0.25Mo (0.35-0.40C)
6457	4140VM	0.95Cr 0.20Mo (0.28-0.33C)
6458	17-22A (S)	0.65Si 1.25Cr 0.50Mo 0.30V (0.28-0.33C)
6461	6130VM	0.95Cr 0.20V (0.28-0.33C)
6462	6130	0.95Cr 0.20V (0.28-0.33C)
6466	502	5.2Cr 0.55Mo
6468	HP9-4-20	1.0Cr 3.8Co 0.45Mo 0.08V (0.14-0.17C)

(Continued on next page)

Aerospace Alloys

Corrosion & Heat Resistant Steels and Alloy Filler Metals		
AMS Spec.	Alloy	Nominal Chemical Composition
5675	Inconel 92	70.0Ni 15.5Cr 7.0Fe 3.0Ti 2.4Mn
5679	Inconel 62	73.0Ni 15.5Cr 2.2Cb 8.0Fe
5680	347 Stainless	18.5Cr 11.0Ni 0.40(Cb+Ta)
5689	321 Stainless	18.0Cr 10.5Ni 0.40Ti
5692	316 Stainless	19.0Cr 12.5Ni 2.5Mo
5694	310 Stainless	27.0 Cr 21.5Ni
5774	AM-350	16.5Cr 4.5Ni 2.9Mo 0.10N
5776	410 Stainless	12.5Cr
5778	Inconel 69	72.0Ni 15.5Cr 2.4Ti 1(Cb+Ta) 0.70Al 7.0Fe
5782	19-9WMo	20.5Cr 9.0Ni 0.50Mo 1.5W 1.2(Cb+Ta) 0.20Ti
5784	29-9 (312)	29.0 Cr-9.5Ni
5786	Hastelloy W	62.5Ni 5.0Cr 24.5Mo 5.5Fe
5789	Stellite 31	54.0Co 25.5Cr 10.5Ni 7.5W
5794	Multimet (N-155)	31.0Fe 21.0Cr 20.0Ni 20.0Co 3.0Mo 2.5W 1(Cb+Ta) 0.15N
5796	Haynes 25 (L-605)	52.0Co 20.0Cr 10.0Ni 15.0W
5798	Hastelloy X	47.5Ni 22.0Cr 1.5Co 9.0Mo 0.60W 18.5Fe
5800	Rene 41	54.0Ni 19.0Cr 11.0Mo 3.2Ti 1.5Al 0.006B
5801	Haynes 188	39.0Co 22.0Cr 22.0Ni 14.5W 0.07La
5804	A286	15.0Cr 25.5Ni 1.3Mo 2.2Ti 0.006B 0.30V

Hastelloy®, Stellite®, Haynes® and Multimet® are registered trademarks of Cabot Corporation.
 Inconel®, Incoloy® and Monel® are registered trademarks of Special Metals Corporation.
 Rene 41® is a registered trademark of Teledyne-Allvac.
 Waspaloy® is a registered trademark of Pratt and Whitney Aircraft.

Silver Brazing Filler Metals		
AMS Spec.	Alloy	Nominal Chemical Composition
5805	A286VM	15.0Cr 25.5Ni 1.3Mo 2.2Ti 0.004B 0.30V
5806	903	42.0Fe 38.0Ni 15.0Co 3.0(Cb+Ta) 1.4Ti 0.92Al
5812	15-7Mo VM	15.0Cr 7.1Ni 2.4Mo 1.0Al
5813	15-7Mo	15.0Cr 7.1Ni 2.4Mo 1.0Al
5817	Greek Ascology	13.0Cr 2.0Ni 3.0W
5821	410 Mod	12.0Cr Ferrite Controlled
5823	Jethete M-190	11.8Cr 2.8Ni 1.6Co 1.8Mo 0.32 V
5824	17-7PH	17.0Cr 7.1Ni 1.0Al
5825	17-4PH	16.4Cr 4.8Ni 0.22Cb 3.2Cu
5826	15-5PH	15.0Cr 5.1Ni 0.30Cb 3.2Cu
5828	Waspaloy	57.0Ni 19.5Cr 13.5Co 4.2Mo 3.1Ti 1.4Al 0.006B
5830	901	12.5Cr 42.5Ni 6.0Mo 2.7Ti 0.015B 25.0Fe
5831	556	29Fe 22Cr 21Ni 18.5Co 3.2Mo 2.8W 0.78Ta 0.30Al 0.05Zr.05La 0.20N
5832	718	52.5Ni 19.0Cr 5.1(Cb+Ta) 0.90Ti 0.50Al 18.0Fe
5836	FM-82	72.0Ni 20.0Cr 3.0Mn 2.5Cb
5837	625	62.0Ni 21.5Cr 9.0Mo 3.7(Cb+Ta)
5838	Hastelloy S	65.0Ni 16.0Cr 15.0Mo 0.30Al 0.06 La
5840	PH13-8Mo	13.0Cr 8.0Ni 2.3Mo 1.1Al

Hardfacing Electrodes

AWS Designation	Recommended Amperage (AC or DC+)					Description, Application & Procedure
300	Dia. (inch)	1/8"	5/32"	3/16"	1/4"	300 is a build-up and overlaying electrode for all ferrous metals subjected to moderate abrasion, severe impact and corrosion. Weld deposits of 300 are strong and tough, however with an average hardness of Rc 26-31, they do remain machinable. Typical applications include tractor rollers, sprockets, idlers, concrete mixer blades, bearing journals and other parts which require machinable weld deposits. Clean the weld area. Use AC or DC+ polarity. Preheating is not required, although heavier sections should be preheated to 200-300°F. Maintain a medium arc length and use a weaving technique or stringer beads up to twice the diameter of the electrode. Avoid the build-up of heat at any one location on the base metal. Remove slag between passes and allow the base metal to air cool. If severe abrasion is encountered, a final pass of AFM 800 should be considered.
	Dia. (mm)	3.2 mm	4.0 mm	4.8 mm	6.4 mm	
	AMPS	60 - 130	120 - 180	170 - 240	240 - 300	
700	Dia. (inch)	1/8"	5/32"	3/16"	1/4"	700 is a severe abrasion and considerable impact hardfacing electrode. Weld deposits have a martensitic structure that resists wear even in metal-to-metal mild steel contact. When used in the flat and horizontal positions, this electrode will exhibit a stable arc and produce weld deposits that are very smooth and finely rippled. Typical applications for 700 include plowshares, cultivator shoes, bucket teeth and lips, well drilling bits, cement mixer blades, shovel tracks and screw conveyors. Use AC or DC+. Preheating is generally not required. Using the weaving technique and keeping a short arc length, deposit up to 1/4" maximum. If more than two passes will be required, it is suggested that a "padding layer" of 300 be used prior to depositing 700.
	Dia. (mm)	3.2 mm	4.0 mm	4.8 mm	6.4 mm	
	AMPS	110 - 130	140 - 170	180 - 210	220 - 300	
800	Dia. (inch)	1/8"	5/32"	3/16"	1/4"	800 is a hardsurfacing electrode used for severe abrasion, light impact, and corrosion resistance. This electrode produces an extremely hard martensite-structure weld deposit which is not machinable in the "as-welded" condition. 800 will lay down a smooth, corrosion resistant weld deposit which will remain extremely hard even at elevated temperatures. Typical applications for 800 include mill hammers, bucket teeth, valve seats, mixers, crusher rolls, tamper rollers, and other mild steel, carbon or alloy steels as well as manganese steels. Use AC or DC+. Preheating is not required except on alloy steels. Using a short gap and a weaving technique, deposit two layers. If more than two passes are required, use 300 to provide a padding layer prior to using 800.
	Dia. (mm)	3.2 mm	4.0 mm	4.8 mm	6.4 mm	
	AMPS	90 - 130	140 - 170	190 - 240	220 - 300	
900	Dia. (inch)	1/8"	5/32"	3/16"	1/4"	900 is a hardsurfacing overlay electrode used for the fabrication and build up of high manganese and alloy steels which are subjected to heavy impact and severe abrasion. The weld deposits have an austenitic structure and work harden although remaining extremely ductile. Weld deposits are machinable and forgeable. Typical applications of 900 include repairing railroad switches, frogs and tracks, bucket teeth and lips, rock crushers, mill hammers and bulldozer parts. When the base metal of 13% manganese steel is hardened, cut-off the hardened zone before welding. Welding should be done at the lowest possible temperature. Maintain a short to medium arc length using a slight weaving technique to make the deposit smooth and even. Water or air cool the weld metal during welding. Do not preheat manganese steels. Do not overheat the base metal. Peening is recommended to relieve stresses.
	Dia. (mm)	3.2 mm	4.0 mm	4.8 mm	6.4 mm	
	AMPS	75 - 130	120 - 190	175 - 240	230 - 280	
Chrom-Carb	Dia. (inch)	3/32"	1/8"	5/32"	3/16"	Chrom-Carb is a chromium-tungsten flux-coated hardsurfacing electrode designed to produce extremely hard weld metal deposits on parts exposed to severe mineral abrasion with low impact. The extreme hardness of Chrom-Carb deposits is achieved through the formation of chromium and tungsten carbides within the matrix of the weld deposit. Typical applications include earth moving and rock crushing equipment, augers, asphalt feed screws, sand pumps, mixer blades and crushing or pulverizing mills, parts which require machinable weld deposits. Maintain a short arc length and hold the electrode vertical to the work piece. Chrom-Carb can be used on both AC or DC machines. Excellent for hardfacing large surface areas using wide weave beads. Chrom-Carb has good operator appeal and yields a very smooth weld bead with superb adherence. Deposition is fast and the weld deposits will last a long time.
	Dia. (mm)	2.4 mm	3.2 mm	4.0 mm	4.8 mm	
	AMPS	70 - 90	110 - 130	160 - 190	220 - 250	
Sugar Rod	Dia. (inch)	1/8"	5/32"	3/16"		Sugar Rod is designed for use on carbon and low alloy steels, manganese steels, and cast iron. Deposits take a high polish, which contributes to high frictional and abrasion wear qualities, especially small particle abrasion. Excellent on applications that need impact as well as abrasion resistance. Provides optimum resistance to this combination. Deposits well out of position. Sugar Rod is recommended for severe abrasion applications, along with moderate impact. This alloy has a good hot hardness up to approximately 1000°F. Especially designed for crusher applications. Used heavily in construction, mining, brick and clay industries on parts such as crusher rollers, jaw crushers, bucket teeth, edges, hammers, mill hammers, conveyor screws, etc.
	Dia. (mm)	3.2 mm	4.0 mm	4.8 mm		
	AMPS	80 - 125	100 - 160	125 - 190		

Hardfacing Wires

AWS Designation	Wire Diameter	Electrode Stickout	AMPS	Volts	Description, Application & Procedure
250	0.045" (1.2 mm)	1/2" - 3/4"	150 - 250	21 - 26	250 is for building up mild and low alloy steel parts to within 3/16"-3/8" of their original size. Weld deposits will be part ferritic-part martensitic in structure. 250 weld deposits have good compressive strength and resistance to plastic deformation. Weld deposits are easily machined in the "as welded" position. An excellent underlayment prior to hardsurfacing. Very good impact resistance; poor abrasion resistance. 250 Underlaying for hardsurfacing, steel mill wobblers and pads, shafting, small rolls, pump parts. Use DC Reverse Polarity (electrode positive). The shielding gas should be 100% CO2 welding grade, however a 75% Argon + 25% CO2 mixture will increase the hardness slightly. Superior properties are achieved if an interpass temperature of 300° - 480°F is maintained.
	1/16" (1.6 mm)	3/4" - 1"	250 - 350	23 - 28	
300	0.045" (1.2 mm)	1/2" - 3/4"	150 - 250	21 - 26	300 is similar to 250 in weld deposit structure and uses. 300 offers a slightly harder weld deposit than 250 and subsequently it is often used in applications where a hardsurfacing layer is not applied over the 300 deposit. Very good impact resistance; poor abrasion resistance. Build-up of power shovels and tractor parts, repairing battered rail, hammers. Use DC Reverse Polarity (electrode positive). The shielding gas should be 100% CO2 welding grade, however a 75% Argon + 25% CO2 mixture will increase the hardness slightly. Superior properties are achieved if an inter pass temperature of 300° - 480°F is maintained.
	1/16" (1.6 mm)	3/4" - 1"	250 - 350	23 - 28	
350	0.045" (1.2 mm)	1/2" - 3/4"	150 - 250	21 - 26	350 has a low alloy deposit that is martensitic in structure. It is machinable and forgeable. A good balance of impact resistance and abrasion resistance as well as hardness make 350 an excellent choice where only one wire is desired for build-up and hardsurfacing. (Not to be used as an underlayment prior to subsequent hardfacing). Very good impact resistance; fair abrasion resistance. Overlaying carbon steel shafts, gear teeth, sprockets, steel shovel pads. Use DC Reverse Polarity (electrode positive). The shielding gas should be 100% CO2 welding grade, however a 75% Argon + 25% CO2 mixture will increase the hardness slightly. Superior properties are achieved if an inter pass temperature of 300° - 480°F is maintained.
	1/16" (1.6 mm)	3/4" - 1"	250 - 350	23 - 28	

(Continued on next page)

AWS Designation	Wire Diameter	Electrode Stickout	AMPS	Volts	Description, Application & Procedure
350	0.045" (1.2 mm)	1/2" - 3/4"	150 - 250	21 - 26	450 is designed for metal to metal abrasion involving impact such as rolling or sliding parts in earth moving equipment where lubrication is not possible. The weld deposits of 450 are martensitic in structure. Very good impact resistance; good abrasion resistance. Mine car wheels, brake drums, tractor rollers, undercarriage parts, shovel idlers, rollers, and hook rolls. Use DC Reverse Polarity (electrode positive). The shielding gas should be 100% CO ₂ welding grade, however a 75% Argon + 25% CO ₂ mixture will increase the hardness slightly. Superior properties are achieved if an inter pass temperature of 300° ~ 480°F is maintained.
	1/16" (1.6 mm)	3/4" - 1"	250 - 350	23 - 28	
450	0.045" (1.2 mm)	1/2" - 3/4"	150 - 250	21 - 26	450 is designed for metal to metal abrasion involving impact such as rolling or sliding parts in earth moving equipment where lubrication is not possible. The weld deposits of 450 are martensitic in structure. Very good impact resistance; good abrasion resistance. Mine car wheels, brake drums, tractor rollers, undercarriage parts, shovel idlers, rollers, and hook rolls. Use DC Reverse Polarity (electrode positive). The shielding gas should be 100% CO ₂ welding grade, however a 75% Argon + 25% CO ₂ mixture will increase the hardness slightly. Superior properties are achieved if an inter pass temperature of 300° ~ 480°F is maintained.
	1/16" (1.6 mm)	3/4" - 1"	250 - 350	23 - 28	
600	0.045" (1.2 mm)	1/2" - 3/4"	150 - 250	21 - 26	600 offers high abrasion and heavy impact resistance on carbon, low alloy and manganese steel. Weld deposits are martensitic and corrosion resistant. 600 is designed for metal to metal and metal to earth abrasion. Weld deposits will work harden when put to service. Excellent impact resistance; excellent abrasion resistance. Extruder screws, bucket lips, tamper feet, tillage tools, dredge parts, ore drag lines, muller tires, and wherever high abrasion and heavy pounding is encountered. Use DC Reverse Polarity (electrode positive). The shielding gas should be 100% CO ₂ welding grade, however a 75% Argon + 25% CO ₂ mixture will increase the hardness slightly. Superior properties are achieved if an inter pass temperature of 300° - 480°F is maintained.
	1/16" (1.6 mm)	3/4" - 1"	250 - 350	23 - 28	
700	0.045" (1.2 mm)	1/2" - 3/4"	150 - 250	21 - 26	700 offers a harder weld deposit than 600, but lacks the corrosion resistance. Primarily used for high metal to metal abrasion. Weld deposits are martensitic in structure and will work harden when put into service. Excellent impact resistance; excellent abrasion resistance. Rollers, conveyor screws, crusher rolls, and mill hammers. Use DC Reverse Polarity (electrode positive). The shielding gas should be 100% CO ₂ welding grade, however a 75% Argon + 25% CO ₂ mixture will increase the hardness slightly. Superior properties are achieved if an inter pass temperature of 300° - 480°F is maintained.
	1/16" (1.6 mm)	3/4" - 1"	250 - 350	23 - 28	

Maintenance & Repair/Hardfacing

AWS Designation	Tensile Strength	Yield Strength	Elongation	Hardness	Description, Application & Procedure
1100	132 ksi	94 ksi	36 %	320 HB	The ultimate electrode for welding all types of steels, without any danger of cracking or breakage. Special "FERRITE BALANCED" Chemistry also allows 1100 to serve as a "STUD PULL" electrode. It is also recommended for repairing worn parts and as an underlay for hardfacing. Due to exceptional strength and crack resistance, it is ideal for repairing tools, dies, spring steel and any dissimilar metal combinations, except for the aluminum and copper alloys.
Cast SM	84 ksi	N/A	27 %	180 HB	A solid core electrode for welding most types of cast irons, including gray cast iron and spheroidal graphite cast iron parts. With a unique non-nickel series core rod, the weld zone of the reclaimed part is almost indistinguishable from the parent material after welding. The Cast SM also has an extremely smooth welding arc and excellent slag fluidity. Weldability, crack resistance, as well as workability and mechanical properties are all excellent.
Cast DM	84 ksi	N/A	27 %	180 HB	A solid core electrode for welding most types of cast irons, including gray cast iron and spheroidal graphite cast iron parts as well as dissimilar metals (carbon steel, stainless). With a unique non-nickel series core rod, the weld zone of the reclaimed part is almost indistinguishable from the parent material after welding. The Cast DM also has an extremely smooth welding arc and excellent slag fluidity. Weldability, crack resistance, as well as workability and mechanical properties are all excellent.

AWS Designation	Deposit Characteristics				Description & Application
Techniwear 31	Hardness	Deposit Thickness	Deposits can be flame cut	Machineable with carbide tools	Medium hardness build-up wire with excellent compressive strength. Recommended for applications where weld deposits must provide good metal-to-metal wear resistance, but still be machinable "as welded". Use on carbon and low alloy steels, machine components, steel mill parts, keyways, carbon steel railroad track components, undercarriage, parts of earth moving and mining equipment, gear teeth, drill string components, rebuilding 4130 and 4140 alloys.
	31-38 Rc	Unlimited			
Techniwear 40	Hardness	Deposit Thickness	Deposits can be flame cut	Machineable with carbide tools	Medium hardness build-up wire with excellent compressive strength. Recommended for applications where weld deposits must provide good metal-to-metal wear resistance, but still be machinable "as welded". Use on carbon and low alloy steels. Machine components, steel mill parts, keyways, carbon steel railroad track components, undercarriage, parts of earth moving and mining equipment, gear teeth.
	31-38 Rc	Unlimited			
Techniwear 40-G	Hardness	Deposit Thickness	Deposits can be flame cut	Deposits are fully machineable	Medium hardness build-up welding wire with excellent compressive strength. Recommended for applications where weld deposits must provide good metal-to-metal wear resistance, but still be machinable "as welded". Use on carbon and low alloy steels.
	32-38Rc	Unlimited			
Techniwear 41-0	Hardness	Deposit Thickness	Deposits can be flame cut	Machineable with carbide tools	Strong, tough, low alloy build-up welding wire. It can be applied to carbon and low alloy steels. Weld deposits are exceptionally sound and dense, and heavy buildups are possible without danger of cracking. Applications: Kiln trunnions, Ingot buggies, Shovel carrier, Dredge ladder rolls, Crane wheels, Driving sprockets, Carbon steel pump shells, Tractor undercarriage idlers and rollers Driving tumblers, Dragline chains, Trencher drive segments and rollers Shovel boom heels, Coupling boxes, Logging arch wheels, Spindles, Saw carriage wheels, Ladder role bearing box, Wobblers Cable sheaves, Dredge driving tumblers, Dredge bucket pins, Wheels on mine cars, Gears shafts and keyways, Miner bearing carrier, Slag ladle cars, Conveyor chain links, Hot metal cars, Power shovel transmission parts
	30-35Rc	Unlimited			
Techniwear 45-0	Hardness	Deposit Thickness	Deposits can NOT be flame cut	Deposit will readily relief check-crack	High hardness multi-carbide hardfacing alloy that resists severe abrasion, including high stress grinding, low stress scratching and gouging abrasion. It maintains its hardness and wear resistance up to 1300°F (700°C). The chemistry is highly tolerant of dilution. One layer will easily outwear two layers of ordinary chrome carbides and in some applications the wear is equal to tungsten carbide. Use on low carbon mild steel, manganese, stainless, and low alloy steels
	63-67Rc	1-2 layers			

(Continued on next page)

FILLER METALS

AWS Designation	Deposit Characteristics			Description & Application	
Techniwear 50	Hardness	Deposit Thickness	Deposits can NOT be flame cut	Deposits are non-machinable	A chromium carbide hardfacing alloy that produces a controlled microstructure of specially sized carbides in a very tough matrix. For applications involving high impact combined with abrasion. Weld metal is tougher than conventional chromium carbide alloys with fewer stress relieving check-cracks.
	45-50 Rc	3-5 layers			
Techniwear 52	Hardness as deposited	Deposit Thickness	Deposits can NOT be flame cut	Poor machinability	Flux-cored, open-arc hardfacing wire that deposits fully austenitic chromium- manganese weld metal. It can be used equally well for joining and build-up/surfacing of carbon, low alloy and manganese steels. Weld deposits have an excellent combination of weld metal strength, ductility and hardness. Work-hardens rapidly under repeated impact. Deposits have very good frictional wear properties and are ideal for railroad applications requiring metal-to-metal wear resistance. Ideal as a cushioning or buffer layer on manganese steel parts that will be repeatedly rebuilt. Since it will not embrittle until 1000°F (538°C), it will act as an insulator to the manganese base metal in helping it keep below 500°F (260°C) during the welding operation. Applications: Pulverizing hammers, Gyrotory crusher mantles, Dragline and power shovel bucket lips and teeth, Crusher rolls and jaws, Sizing screens, Cone and roll shells, Grizzly bars, Hammer mill, hammers Steel mill wobblers
	20Rc	As required			
Techniwear 55	Hardness as deposited	Deposit Thickness	Deposits can be flame cut	Deposits are fully machinable	Work-hardening austenitic manganese flux-cored, open- arc wire, alloyed with chromium and nickel for improved weld deposit properties over standard manganese alloys. It is designed for buildup, hardfacing and fabricating of manganese steel. Deposits are very tough, and work-harden rapidly in service as plastic deformation occurs during impact. Applications: Crusher jaws, Hammer mill hammers, Cones and roll shells, Impact breaker bars, Gyrotory crusher mantles, Joining of manganese steel components
	15-20Rc	As required			
Techniwear 55-E	Hardness as deposited	Deposit Thickness	Deposits can be flame cut	Poor machinability	Ideal for use on manganese steel. Under severe impact, such as hammering or pounding, deposits quickly become tougher and harder, and will not spall or mushroom. Techniwear 55-E may be used alone, as a combination buildup and hardfacing alloy, or used as a buildup and cushion prior to overlaying with a more abrasion resistant alloy. Techniwear 55-E is an all-position electrode for joining or overlaying for high impact. It operates on either AC or DC reverse; the arc is smooth and stable with low spatter loss. Slag removal is easy. Applications: Coal crushing segments, Shovel drive sprockets, Dipper teeth and lips, Gear teeth and attaching wear plates, Crusher pads
	15-22Rc	As required			
Techniwear 56-E	Hardness	Deposit Thickness	Weld deposits will relieve check-crack readily	Deposits are fully machinable	Techniwear 56-E produces a multi-carbide weld deposit that resists many types of wear. The weld-deposit is a tightly packed, dense, inter-connected network of chromium carbides, vanadium carbides, molybdenum carbides, niobium carbides and tungsten carbides. Weld deposits offer exceptional wear resistance to general abrasion, high stress grinding, low stress scratching and erosion. Impact resistance is limited. This alloy may also be used at elevated temperatures up to 1500°F (816°C). First pass hardness is greater than other hardface electrodes - 65Rc on mild steel. Other outstanding features include: Excellent AC or DC operation, Low amperage and high metal recovery - no slag to chip, High deposition rates - up to 3 times faster than ordinary electrodes, Moisture resistant coating, even under severe weather or high humidity Applications: Solid waste shredder parts, Agricultural implements, Earth moving and construction equipment, Cement mill parts, Brick making equipment, Cereal grinding equipment and miller plows
	65Rc	2layers			
Techniwear 56-G	Hardness	Deposit Thickness	Deposits can be flame cut	Non Machinable, must be ground	Abrasion resistant Techniwear 56-E is a general purpose self-hardening overlay with a good combination of resistance to abrasion and impact. Very tough with excellent resistance to chipping and spalling. Deposits will retain their hardness and maintain a good cutting edge up to 1100°F (593°C). For maximum impact resistance and to avoid cracking in multi-layer deposits, a preheat of 550°F (288°C) is recommended. Use to overlay carbon, low alloy steel and manganese steel. Applications: Hot Shear Blades, Dozer Blades, Shearing and piercing dies, Tamper feet, Bucket Teeth, Farm Implements Augers
	55-59Rc	Unlimited layers with proper procedures			
Techniwear 57-0	Hardness	Deposit Thickness	Non-cracking with proper preheat and post heat temperatures and procedures	Non Machinable, must be ground	Techniwear 57-0 is a general purpose flux-cored, open-arc hardfacing wire providing a good combination of abrasion resistance and toughness. Use to overlay carbon and low alloy steel and manganese steel. This product delivers weld metal that is resistant to metal to metal rolling, or wear including mild abrasive wear resistance. Applications: Tillage tools, Bulldozer blades and end bits, Conveyor screws, Dragline scrapers, Backhoe buckets, Dragline chain idlers, Clamshell buckets, Agitator bearings and shafts, Shovel and dragline bucket lips and teeth, Sprockets, Tractor grousers, Gudgeon hangers and pins
	50-59Rc	Unlimited layers with proper procedures			
Techniwear 58	Hardness	Deposit Thickness	Non-cracking with proper preheat and postheat temperatures	Non Machinable, must be ground	Abrasion resistant. Techniwear 58 is a general purpose flux-cored, open-arc hardfacing wire providing a good combination of abrasion resistance and toughness. Use for metal-to-metal-to-earth wear applications. Use to overlay carbon and low alloy steel and manganese steel. Multiple layers can be applied with proper preheat and inter- pass temperature. Applications: Tillage tools, Bulldozer blades and end bits, Conveyor screws, Dragline scrapers, Backhoe buckets, Dragline chain idlers, Clamshell buckets, Agitator bearings and shafts, Shovel and dragline bucket lips and teeth, Sprockets, Tractor grousers, Gudgeon hangers and pins
	55-59Rc	Unlimited layers with proper procedures			
Techniwear 59TIC-0	Hardness	Deposit Thickness	Deposits can NOT be flame cut	Non Machinable, must be ground	Techniwear 59TIC-0 is a non-cracking flux-cored, open-arc hardfacing wire that deposits a martensitic alloy with a high volume of finely dispersed Titanium Carbides (TiC). It has excellent abrasion resistance under low and high stress conditions and retains hardness at high temperatures. Crack-free deposits are possible with proper procedures. Use on carbon and low alloy steels. Excellent welding characteristics. Multiple layers maintain their hardness and abrasion resistance. Produces full slag coverage that does not require removal between passes. Slag is easily removed with a chipping hammer. Deposits are crack-free even after multiple layers Applications: Cement rolls, Hardbanding drill pipes Hammers, Bucket pins, Shredder & Fibrizer hammers, Bucket teeth and lips, Tillage implements, Augers, Asphalt mixer paddles
	57-60Rc	Unlimited layers with proper procedures			

(Continued on next page)

AWS Designation	Deposit Characteristics				Description & Application
Techniwear 60	Hardness	Deposit Thickness	Deposits can NOT be flame cut	Deposits will check-crack to relieve stresses	Specially formulated chromium carbide alloy developed to produce a superior high polish abrasion resistant deposit in service. The tough alloy matrix combination is designed for high abrasion and moderate impact. Heat resistant to 1000°F (538°C). Use on low carbon mild steel, manganese, stainless, and low alloy steels. Good out of position capabilities. Fast freezing weld deposit. Very good weld bead tie-in. Ideal for dirty surfaces. Works well for sugar mill roll teeth Applications: Tampers, Dredge bucket lips, Dredge pump side plates, Coal pulverizing hammers, Grizzly bars, Dredge cutter head & teeth, Bulldozer blades, Crusher rolls, Shredder & Fibrizer Hammers, Clamshell bucket lips, Dragline buckets, Crusher jaws and cones, Power shovel buckets and teeth, Gyrator crusher mantles, Road rippers and scraper blades, Muller tires, Augers, Sugar mill roll teeth
	54-60Rc	1-3 layers			
Techniwear 61	Hardness	Deposit Thickness	Deposits can NOT be flame cut	Deposits are non-machineable	A premium chromium carbide alloy that has a high volume fraction of carbides dispersed in a hard matrix. For applications involving high abrasion and mild or moderate impact. Deposit polish in service and are heat resistant to 1000°F (531°C). Use on carbon and low alloy steels. Scrapper blades, auger flights, road ripper teeth, screw conveyors, bucket teeth bucket sides and bottoms, mixer blades, tillage tools, fan blades.
	58-62 Rc	1-2 layers			
Techniwear 64-G	Hardness	Deposit Thickness	Deposits can NOT be flame cut	Non Machinable, must be ground	Techniwear 64-G is a non-cracking martensitic tool steel type hardfacing alloy with numerous tightly packed carbides for excellent abrasion resistance under high impact. Deposits are smooth and free of any slag. One layer deposits exhibit wear characteristics that you would expect from chromium carbide hardfacing products. An excellent choice for applications requiring crack-free deposits with good wear characteristics. Use on carbon and low alloy steels. Applications: Scraper blades, Road ripper teeth, Bucket teeth, Tillage tools, Auger flights, Mixer blades, Fan blades, Shredder & Fibrizer Hammers
	57-61Rc	Unlimited layers with proper procedures			
Techniwear Chrome Free 65	Hardness	Deposit Thickness	Deposits can NOT be flame cut	Non Machinable, must be ground	Techniwear CF65 is an economical high hardness, chromium-free hardfacing overlay designed for applications involving general abrasion or abrasion combined with impact. Machinery and parts in surfacing mining, deep mining, recycling/demolition, tunneling, construction, earth moving, agriculture, processing, mineral processing, dredging, quarry equipment.
	60-65 Rc	2 layers			
Techniwear 67-G	Hardness	Deposit Thickness	Deposits can NOT be flame cut	Non Machinable, must be ground	Techniwear 67-G is a non-cracking abrasion resistant, gas-shielded, modified high speed tool steel welding wire designed for applications where edge retention is a primary concern. Weld deposits are martensitic with micro-carbides evenly dispersed throughout the deposit. These properties create a crack-free fracture resistant cutting edge even under high compression loads. Applications: Hot or cold trim dies, Shear blades, Blanking dies, Cutting tools, Shearing and piercing dies, Tire recycling knives
	60-65Rc	2-3 layers			
Techniwear VC-0	Hardness	Deposit Thickness	Deposits can NOT be flame cut	Non Machinable	Techniwear VC-0 is a tubular metal-cored hardfacing wire that provides a dense, heterogeneous deposit of vanadium - tungsten carbides, along with other elements to enhance wear resistance, resulting in a very good combination of abrasion and impact resistance that is superior to chromium carbide hardfacing alloys. Almost equal to tungsten carbide in hardness, and half the weight. Vanguard™ PS-150 is not a replacement for tungsten carbide overlays. However, it is a good alternative to tungsten carbide hardfacing alloys when they are too expensive or when MIG carbide embedding is not available or impractical. Unlike straight tungsten carbides, which are heavy and forced to the bottom of the weld puddle, the composition of Techniwear VC-0 is ideally balanced to provide a uniform distribution of vanadium - tungsten carbides throughout a tough steel matrix that takes more impact than both chromium and tungsten carbides. Provides a much more consistent wear rate and is much more receptive to multiple re-applications. Used for many different hardfacing applications in mining, construction, recycling, dredging and forestry and is ideal for hammer applications (martillo), such as fibrizor hammers, sugar mill hammers, debarking hammers and shredding hammers. Applications: Ammonia injector knives, Conveyor screws, Ditch and trenching teeth, Debarking hammers, Augers, Shredder and Fibrizer hammers, Drill collars, Dozer end bits, Grinding equipment, Recycling wear parts, Stabilizers, Shovel bucket sides, lips, teeth and adapters, Rippers, Shredder hammers, Sub-soilers, Sugar cane cutting knives, Sugar cane hammers, Fibrizer cane hammers
	59-61 Rc	Multiple			

Maintenance Alloys

AWS Designation	Tensile Strength	Yield Strength	Elongation	Description, Application & Procedure
Patricarc	Up to 120,000 psi	Up to 90,000 psi	Up to 30 %	<ul style="list-style-type: none"> • High deposition rate. • Weld deposits are smooth, ductile, porosity-free and take on a shiny appearance. • Weld deposits are impact, abrasion, heat and corrosion resistant. Dissimilar steels, high carbon, tool and die steels, and aircraft steels. Underlayment of hardfacing alloys in mining applications, rebuilding shafts and agitator blades in turbines, frames, cast steel parts and gears. Also perfect to use when the base metal is unknown. Clean the work area. Thick sections should be beveled. A preheat of 400°F is recommended for carbon and cast steels. Maintain a short arc, slightly in the direction of movement and use stringer beads. Peening is recommended.
AM Steel-LH	Up to 80,000 psi	N/A	N/A	<ul style="list-style-type: none"> • High tensile strength ferritic electrode. • High quality, all position, low amperage electrode features rapid deposition. • Deposits have good ductility, are dense, crack-free, and of x-ray quality. • Excellent for steels sensitive to cracking when welded with conventional mild steel electrodes. For "tramp" and "problem" steels high in sulphur, phosphorous, or other elements added to improve the machinability of the steel. For fabrication of "H" and "I" beams, angle and channel iron, pipelines, and all other steel structures. For circular tubes to plate welds, and other type joints subject to stress and strain. Area to be welded should be cleaned thoroughly. Surface contamination must be removed and bevel or chamfer where required. Maintain close arc length. Vertical joints should be welded from bottom up, using rapid weave technique. Do not whip. Use drag technique to make horizontal fillet welds. Slag is easily removed.

(Continued on next page)

FILLER METALS

AWS Designation	Tensile Strength	Yield Strength	Elongation	Description, Application & Procedure
AM Steel-1	Up to 85,000 psi	Up to 60,000 psi	Approx. 25 %	<ul style="list-style-type: none"> • Low amperage capability makes it excellent for poor fit-up applications and use on low, open circuit voltage buzz boxes. • Special coating allows it to weld over extremely dirty, greasy, oil soaked and/or rusty steels. • Also can weld over its own slag without causing inclusions or slag interference. • It is not necessary to chip slag between passes. <p>Ideal for production, as well as maintenance applications where poor fit-up is encountered. The ability to maintain a stable arc at low amperages also makes it excellent for applications involving light gauge steel. Amsteel-1 easily welds on steel beams and girders that have many coats of paint without developing porosity or defective welds. Welds are also easily made on equipment or machines that are covered with grease and sand and can't be cleaned before welding. Designed for pipeline welding, tank fabrication, machine and automotive repair, as well as general construction and fabrication. If possible, clean the weld areas as much as is practical. Set the amperage to the specific requirements. If an edge build-up is required or it is thin steel, use the lower end of the amperage range. If heavy penetration is required or the weld area is extremely dirty, use the higher end of the amperage range. A close to medium arc gap should be maintained. Slag chipping is recommended, but not necessary on multipass applications.</p>
AM Steel-2	Up to 80,000 psi	Up to 68,000 psi	Approx. 2 %	<ul style="list-style-type: none"> • High deposition rate. • Weld deposits are smooth, ductile, porosity-free and take on a shiny appearance. • Weld deposits are impact, abrasion, heat and corrosion resistant. <p>Dissimilar steels, high carbon, tool and die steels, and aircraft steels. Underlayment of hardfacing alloys in mining applications, rebuilding shafts and agitator blades in turbines, frames, cast steel parts and gears. Also perfect to use when the base metal is unknown. Remove as much foreign material as practical from the weld area. DC reverse polarity (electrode +) produces deep penetration; DC straight polarity (electrode -) will have limited penetration and a flatter bead. AC prevents arc blow. A medium arc length should be maintained with either stringer or weave beads. Slag is easily removed with a light chipping hammer.</p>
Chamfer Arc	N/A	N/A	N/A	<ul style="list-style-type: none"> • High speed cutting electrode for use with all standard arc equipment. • No special skills, oxygen tanks, or air compressors are required. • Special coating protects the electrode from overheating. <p>Cutting, beveling, and piercing of cast iron, stainless steel, manganese steel, carbon steel, malleable iron, aluminum, copper, bronze, nickel and nickel alloys. Ideal for cleaning out defects and removing rivets. The fastest and cleanest cuts use DC straight polarity (electrode -). When piercing, hold electrode vertical to work, strike arc, and push in and out until hole has been formed. When cutting sheets or plates, start at the edge, strike arc, and use electrode like a saw; push and pull with the electrode at a 45° angle to the work piece. In all cases the arc must be kept as short as possible.</p>
AM Premium Cast-1	Up to 60,000 psi (415 N/mm2)	N/A	N/A	<ul style="list-style-type: none"> • High-strength alloy for dirty cast iron. • Machinable deposits. • Specially designed for contaminated, oil-soaked cast iron. • Alloyed core wire with unique flux coating produces strong, crack-resistant welds. <p>Joining cast iron to steel, transmission gear housings, gray, ductile & nodular cast iron, sewer pipes.</p>
Cast Weld-1	Up to 50,000 psi (345 N/mm2)	N/A	N/A	<ul style="list-style-type: none"> • Premium high nickel alloy for cast iron. • Maximum machinability of deposit and HAZ. • Pulsating arc for low temperature welding of cast iron in all positions. • Pulsating arc removes impurities resulting in a porosity-free weld deposit. <p>Engine blocks, joining cast iron to steel, gear housings, joining cast iron to stainless steels.</p>
Cast Weld-2	Up to 75,000 psi (520 N/mm2)	N/A	N/A	<ul style="list-style-type: none"> • Maximum strength alloy for cast iron. • Special bi-metal core wire prevents overheating of electrode. • Soft arc allows for easy machinability of highly crack-resistant weld deposit. • Pulsating arc on DC- and AC removes impurities from base material, even on dirty, oily surfaces. • Suitable for welding cast iron to steel. <p>Cylinder heads, machine bases, ship engine manifolds, filling holes, cast gear teeth, pump housings.</p>
Cast Weld-3	Up to 140,000 psi (965 N/mm2)	Up to 120,000 psi (827 N/mm2)	N/A	<ul style="list-style-type: none"> • Nickel-free electrode with non-machinable deposit. • Formulated for dirty and difficult-to-weld cast iron. • Suitable for joining problem cast iron to steel. • Successfully used when nickel alloys fail to adhere. <p>Burned furnace grates, cracked machine bases, build up of abrasion, pump housings worn areas, low quality cast iron.</p>
Impact Arc	Up to 140,000 psi (965 N/mm2)	Up to 120,000 psi (827 N/mm2)	N/A	<ul style="list-style-type: none"> • High chromium, high manganese alloy for joining and rebuilding manganese and carbon steel plates. • High alloy deposits are very tough and will take extreme impact and abrasion conditions. • Has excellent weldability with very low spatter. • Operates easily in all positions. <p>Rebuilding and joining austenitic manganese steels and manganese steels to other steel combinations. Especially designed for high impact applications such as rail frogs and switch points, roller crushers, hammers, shovel tracks. Also excellent for use as a base for harder overlays. Remove any hardened or fatigued material from the surface with AFM Chamfer Arc. Deposits may be placed with either the stringer bead or weaving technique. This electrode deposits easily in all positions with excellent build-up quality. Avoid overheating on manganese steel base metals. Deposits work harden rapidly.</p>
Abrasarc	N/A	N/A	N/A	<ul style="list-style-type: none"> • General purpose surfacing alloy for surfaces subjected to abrasive wear and impact. • Crack resistant deposits, but can be forged. • Heavy build-ups are possible without the need for softer cushion layers. <p>Buildup and surfacing of new or worn machine parts of steel, cast steel, and manganese steel, dredger teeth, crusher jaws, hammer mill parts, conveyors, pressure rollers, shovel teeth, stampers, caterpillar drives, and earth borers. Remove all foreign material from weld area. Preheat is not necessary. Maintain a medium arc length making either stringer beads or weave beads. Allow part to cool slowly.</p>

(Continued on next page)

AWS Designation	Tensile Strength	Yield Strength	Elongation	Description, Application & Procedure
Bronze Arc	Up to 50,000 psi (345 N/mm ²)	N/A	30 %	<ul style="list-style-type: none"> • AC/DC+ Tin/Bronze electrode for joining and surfacing. • All position electrode with minimum spatter and easy slag removal. • Excellent color match to bronze. • Offers good resistance to sea water and other chemicals. Arc brazing galvanized sheets, impellers, defects in new bronze castings, gear wheels
Bronze G	Up to 70,000 psi (483 N/mm ²)	N/A	N/A	<ul style="list-style-type: none"> • Super strength, general use brazing rod. • Excellent for overlaying & build-up at low temperatures (1400°-1600°F). • Excellent for close fitting joints, thin-flowing at high-temperatures (1650°-1750°F). • Designed to build-up or join carbon steels, alloy steels, cast iron, and many nonferrous materials. • Super active flux promotes ultra-thin flowing of alloy. Gear teeth build-up, attaching carbide cutting tips, build-up of bearing shafts, joining bicycle assemblies, brazing of rusty surface, heavy equipment repair.
Alum Arc	Up to 25,000 psi (173 N/mm ²)	N/A	N/A	<ul style="list-style-type: none"> • Universal flux-coated aluminum stick electrode for arc welding or gas welding. • Ideal for outdoor use when MIG/TIG welding is not suitable. • Exceptional arc stability at low amperages with minimum spatter. • Deposits have excellent corrosion resistance and color match. - Build-up of castings - Aluminum castings - Repair of machining errors - Tanks & Pipes
Alum Cor	Up to 30,000 psi (207 N/mm ²)	N/A	20 %	<ul style="list-style-type: none"> • Unique flux-cored aluminum brazing rod. • Excellent for build-up and repair of all weldable grades of aluminum including cast alloys. • Designed especially for dirty applications. • Can be applied in all positions using an oxy-fuel torch. • Ideal for joining dissimilar sizes and for poor fit-up applications. - Cast engine blocks - Oily casting repairs - Aluminum pump housings - Automotive parts



GRIP STAR
**FOR ALL YOUR HAND, CLAMPING,
AND PIPING TOOL NEEDS**

Clamps	97
Pipe Stands & Heads	
Chipping Hammers	98
Hand Tools	
Magnetic Holders	

Grip Star™ Clamps

Features:

- Heavy-Duty Casted C-Clamp
- Anti-Slip protection features included in even base models
- Copper-Plated spindle for spark protection

Item Number	Style
CC402	C-CLAMP 2"
CC404	C-CLAMP 4"
CC406	C-CLAMP 6"
CC408	C-CLAMP 8"
CC410	C-CLAMP 10"
CC412	C-CLAMP 12"
TW600B	BATTERY CLAMP BLACK 600/AMP
TW600R	BATTERY CLAMP RED 600/AMP
TW600ST	BATTERY CLAMPS SET RED & BLACK 600/AMP

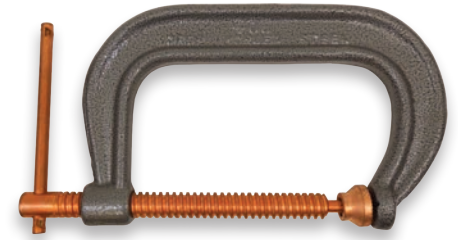

CC406



TW600ST

Grip Star™ Pipe Stands

Features:

- Fully UPS-able fold up design
- Heavy-Duty welded design
- Heavy-Duty scratch resistant powder coated paint
- All parts are compatible with Sumner

Item Number	Style	Load Capacity
GSFOLDJACK	FOLDING PIPE STAND WITH CARRY HANDLE	2500 LB
GSFOLDLOW	LOW FOLDING PIPE STAND	2500 LB
GSFOLDROLL	FOLDING STAND WITH ROLLER HEAD	2500 LB
GSLOWJACK	LOW-JACK STATIONARY PIPE STAND	2500 LB
GSPROROLL	TECHNI-JACK 24" HI-BOY STATIONARY ROLLER HEAD PIPE JACK	2000 LB
GSSHR	HI ADJUST-A-ROLL WITH ALUMINUM ROLLER WHEELS	2000 LB
GSFOLDROLLLOW	LOW, FOLD-A-JACK, ST-982 WITH ROLLER HEAD	2500 LB
GSPROJACK	HI-JACK STATIONARY PIPE STAND	2500 LB



GSFOLDJACK



GSRHEADS

Grip Star™ Pipe Stand Heads

Item Number	Style	
GSVHEAD	STANDARD V-HEAD FOR GSFOLDROLL	-
GSRHEADL	ROLLER HEAD FOR GSPROROLL	-
GSRHEADS	ROLLER HEAD FOR GSFOLDROLL	-
GSPROLLERHEAD	ROLLER HEAD WITH STEEL WHEELS	-
GSBALLTRANSFER	BALL TRANSFER HEAD, TWO PER PACKAGE, SOLD AS PAIR	-



CHRLA1



CHRLHWH



GSMIGWELPERS



RTP20



MAGHOLDER

Grip Star™ Chipping Hammers

Features:

- Ideal for cleaning up excess welding slag build-up
- Manufactured with high carbon steel and engineered to last

Item Number	Style
CHRLA1	CHISEL & BRUSH DUAL TOOL WITH SPRING HANDLE (A-1 STYLE)
CHRLH1C	CONE & CROSS CHIPPING HAMMER WITH SPRING HANDLE (S30 STYLE)
CHRLH1S	CONE & CHISEL CHIPPING HAMMER WITH SPRING HANDLE (H STYLE)
CHRLH1SBE	CONE & CHISEL CHIPPING HAMMER WITH SPRING HANDLE (H STYLE)
CHRLHWH10	CHISEL & CROSS CHIPPING HAMMER WITH WOOD HANDLE (WH-10 STYLE)
CHRLHWH20	CONE & CHISEL CHIPPING HAMMER WITH WOOD HANDLE (WH-20 STYLE)
CHRLHWH30	CONE & CROSS CHIPPING HAMMER WITH WOOD HANDLE (WH-30 STYLE)
CHRLHWH40	CURVED CONE & CROSS CHIPPING HAMMER WITH WOOD HANDLE (WH-40 STYLE)

Grip Star™ Hand Tools

Cutters

Item Number	Style
TEC46077	AUTO LOADING UTILITY KNIFE
TEC57455	9-1/2 CABLE CUTTER

Fillet Gauges

Item Number	Style
TECWG8	WG-8 WELD GAUGE CAM TYPE
TECWG11	WG-11 FILLET WELD GAUGE

Pliers

Item Number	Style
GSMIGWELPERS	WELPER STYLE PLIERS
TEC56027	4/PCS LOCKING PLIERS SET
TEC57080	4 PIECE GROOVE JOINT PLIERS SET
TEC57075	12" TONGUE & GROOVE JOINT PLIERS

Wrenches

Item Number	Style
TEC87112	12 ADJ WRENCH WITH BLACK OXIDE FINISH
RTP5	#5 B & MC WRENCH
RTP10	#10 STRAIGHT COMMERCIAL ACETYLENE WRENCH
RTP1013	#10 WAY WRENCH
RTP20	#20 STRAIGHT COMMERCIAL ACETYLENE WRENCH
RTP250T	T-HANDLE WRENCH POL ACETYLENE 1/4

Grip Star™ MAGHOLDERS

Item Number	Style
MAGHOLDERS	GRIP STAR MAGNETIC HOLDER SMALL (2.5 INCH)
MAGHOLDERM	GRIP STAR MAGNETIC HOLDER MEDIUM (3 INCH)
MAGHOLDERL	GRIP STAR MAGNETIC HOLDER LARGE (3.5 INCH)
MAGHOLDERXL	GRIP STAR MAGNETIC HOLDER EXTRA LARGE (5 INCH)



MIG STAR

FOR ALL YOUR MIG GUNS, PARTS AND ACCESSORIES

- All MIG Star™ Guns are rigorously tested using computerized and automated test equipment at the design stage and throughout the entire production process.
- All of our components pass rigorous quality control checks prior to assembly.
- Our extensive range of Front End Consumables are manufactured to the highest specification.
- All MIG Star™ Guns are designed to be tough and damage resistant and comply with EN60974-7.

Features & Benefits 100

Air Cooled MIG Welding Gun

MIG Star™ No. 2 101-103

MIG Star™ No. 4 104-106

Additional MIG Star™ Accessories

Nozzles, Contact Tips, 106

Gas Diffusers, Liners

MIG Star™ Holder & Welding Cart 106

MIG Star™ Gun - Features & Benefits

Tweco®, Miller®, Lincoln®, Euro-kwik® compatible

NEW Ergonomic Handle

- Maximizes user comfort
- Ergonomic design for balance and strength
- Enhances wire feeding performance

Swan Necks

- A copper core provides excellent heat dissipation
- Stainless Steel Outer Jacket
- Durable and Robust

Contact Tips

- Manufactured using a harder and higher conductivity copper alloy for industry leading durability

Nozzles

- Maximize performance
- Manufactured from copper to enhance heat dissipation
- Adjustable tip recess
- Manufactured to exacting specifications

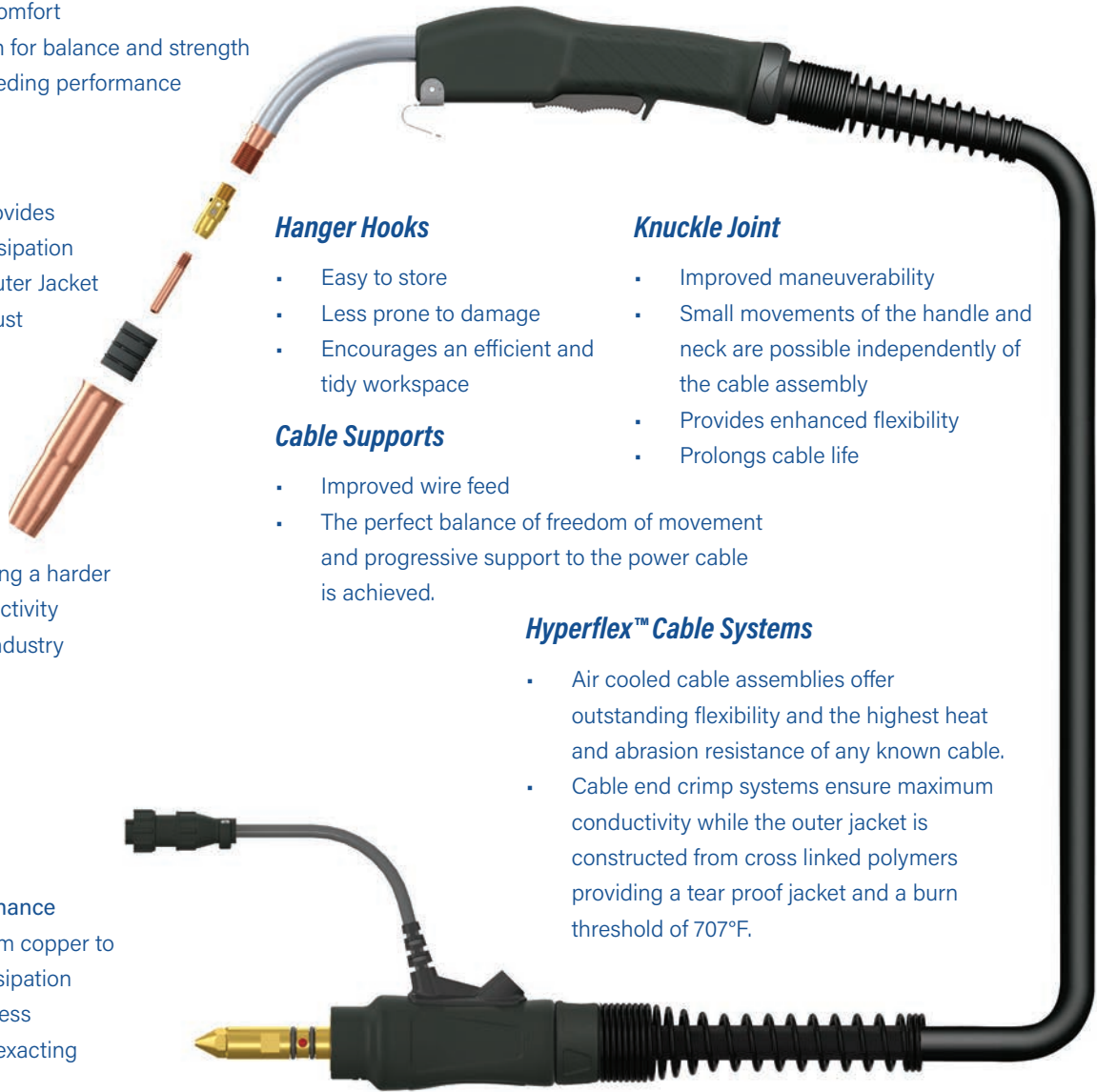

Hanger Hooks

- Easy to store
- Less prone to damage
- Encourages an efficient and tidy workspace

Cable Supports

- Improved wire feed
- The perfect balance of freedom of movement and progressive support to the power cable is achieved.

Knuckle Joint

- Improved maneuverability
- Small movements of the handle and neck are possible independently of the cable assembly
- Provides enhanced flexibility
- Prolongs cable life

Hyperflex™ Cable Systems

- Air cooled cable assemblies offer outstanding flexibility and the highest heat and abrasion resistance of any known cable.
- Cable end crimp systems ensure maximum conductivity while the outer jacket is constructed from cross linked polymers providing a tear proof jacket and a burn threshold of 707°F.

Gun Plug Bodies

- Spring loaded pins
- Guaranteed gas seals

Machine End Systems

- Extra length cable support systems
- Smooth and consistent wire feed
- Simple snap fits

MIG Star™ - No. 2

Air Cooled MIG Welding Gun

Rating: 200A CO₂, 150A Mixed Gas @ 60% Duty Cycle
EN60974-7 0.0239 - .0459/0.6mm to 1.2mm wires

TWECO® compatible



Assembled Stocked Models

Item Number	Model Description
MST20015	200 AMP TWECO® STYLE TWECO® COMPATIBLE BACK END 15' MIG GUN
MSM20015	200 AMP TWECO® STYLE MILLER® COMPATIBLE BACK END 15' MIG GUN
MSM20025	200 AMP TWECO® STYLE MILLER® COMPATIBLE BACK END 25' MIG GUN
MSL20015	200 AMP TWECO® STYLE LINCOLN® COMPATIBLE BACK END 15' MIG GUN
MSL20015N	200 AMP TWECO® STYLE LINCOLN® L3 COMPATIBLE BACK END 15' MIG GUN
MSL20025N	200 AMP TWECO® STYLE LINCOLN® L3 COMPATIBLE BACK END 25' MIG GUN
MSX20015	200 AMP TWECO® STYLE EURO COMPATIBLE BACK END 15' MIG GUN

PACKAGE INCLUDES:

- 200 AMP TWECO® STYLE MIG GUN
- ADJUSTABLE NOZZLE
- ADJUSTABLE NOZZLE INSULATOR
- CONTACT TIP
- GAS DIFFUSER
- CONDUCTOR TUBE
- HANDLE KIT
- TRIGGER SWITCH
- LINER CONDUIT

(Continued on next page)

MIG Star™ - No. 2

Air Cooled MIG Welding Gun

Rating: 200A CO₂, 150A Mixed Gas @ 60% Duty Cycle
 EN60974-7 0.0239 - .0459/0.6mm to 1.2mm wires

TWECO® compatible

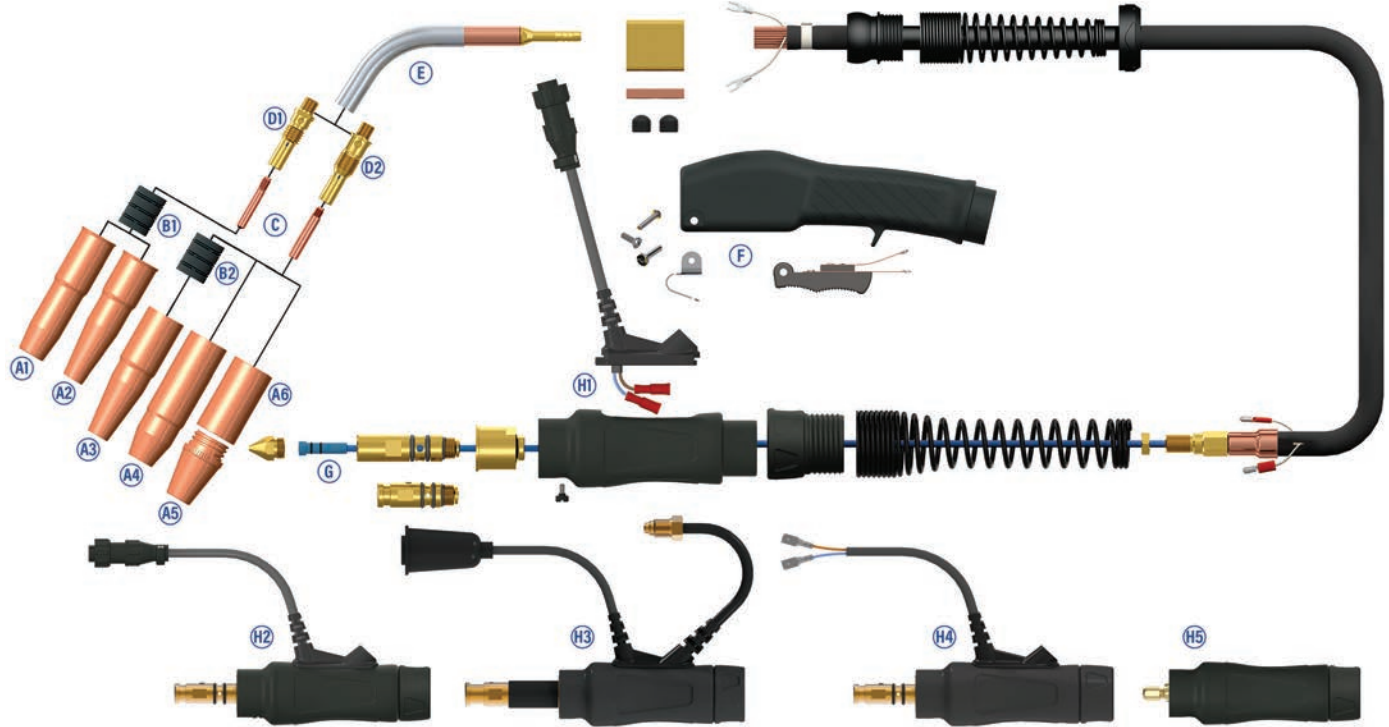

A Nozzles (200 AMP)		
A	Item Number	Description
1	MS2250	Nozzle Adjustable 1/2" (13mm)
	MS2262	Nozzle Adjustable 5/8" (16mm)
	MS24A50*	Nozzle Adjustable 1/2" (13mm) use w/34A
	MS24A62*	Nozzle Adjustable 5/8" (16mm) use w/34A
	MS24A75	Nozzle Adjustable 3/4" (19mm) use w/34A
	MS24AH62*	Nozzle HD Adjustable 5/8" (16mm) use w/34A
2	MS2250SS	Nozzle Adjustable 1/2" (13mm) Short Stop
	MS2262SS	Nozzle Adjustable 5/8" (16mm) Short Stop
	MS24A62SS*	Nozzle Adjustable 5/8" (16mm) Short Stop use w/34A
3	MS23T37	Nozzle Self insulated 3/8" (9.5mm) Tapered
	MS2350F*	Nozzle Self Insulated 1/2"(13mm) Flush
4	MS2137	Nozzle Self Insulated 1/2" (13mm)
	MS2150	Nozzle Self Insulated 5/8" (16mm)
	MS2162	Nozzle Self Insulated 3/4" (19mm)
	MS2337 *	Nozzle Self insulated 3/8" (9.5mm)
	MS2350*	Nozzle Self Insulated 1/2" (13mm)
	MS2362*	Nozzle Self Insulated 5/8" (16mm)
	MS2375*	Nozzle Self Insulated 3/4" (19mm)
5	MS24CT62S*	Nozzle 5/8" (16mm) Recessed use w/MS34CT
6	MS34CT*	Nozzle Insulator w/Coarse Thread Nozzles

B Nozzle Insulator (200 AMP)		
B	Item Number	Description
1	MS32	Nozzle Insulator
	2	MS34A*

C Contact Tips (200 AMP)		
C	Item Number	Description
	MS1123	Contact Tip .023" (0.6mm) Wire Size
	MS1130	Contact Tip .030" (0.8mm) Wire Size
	MS1135	Contact Tip .035" (0.9mm) Wire Size
	MS1145	Contact Tip .045" (1.2mm) Wire Size
	MS1423*	Contact Tip .023" (0.6mm) Wire Size
	MS1430*	Contact Tip .030" (0.8mm) Wire Size
	MS1435*	Contact Tip .035" (0.9mm) Wire Size
	MS1445*	Contact Tip .045" (1.2mm) Wire Size
	MS1452*	Contact Tip .052" (1.32mm) Wire Size
	MS14H35*	HD Contact Tip .035" (0.9mm) Wire Size
	MS14H45*	HD Contact Tip .045" (1.2mm) Wire Size
	MS14H52*	HD Contact Tip .052" (1.32mm) Wire Size
	MS14HT45	HD Tapered Contact Tip .045" (1.2mm) Wire Size
	MS14T35*	Tapered Contact Tip .035" (0.9mm) Wire Size
	MS14T45*	Tapered Contact Tip .052" (1.3mm) Wire Size
	MS14T52*	Tapered Contact Tip .052" (1.3mm) Wire Size

*Compatible with MIG Star™ No. 4 (400 AMP MIG Gun)

(Continued on next page)

MIG STAR

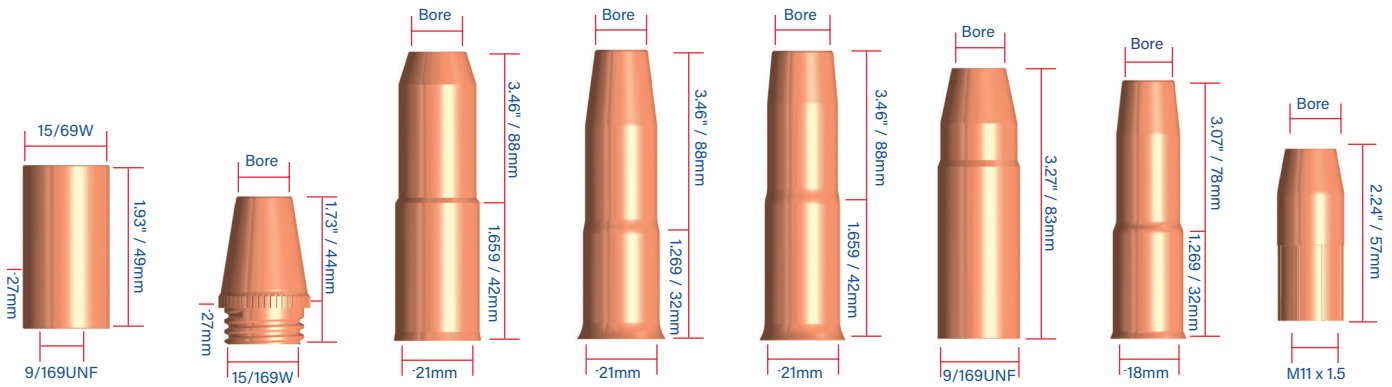

D Gas Diffusers (200 AMP)		
Item Number	Description	
1	MS52	Gas Diffuser 1/4UNF Tip Thread
2	MS52FN	Gas Diffuser 1/4UNF Tip Thread

F Handle Kit & Trigger Switch (200 AMP)		
Item Number	Description	
MS82HK	Handle Kit c/w Screws and Support	
MS92	Trigger Switch	

E Swan Neck Conductor Tubes (200 AMP)		
Item Number	Description	
MS62J60	60° Conductor Tube	
MS62J45	45° Conductor Tube	

G Liners (200 AMP)		
Item Number	Description	
MS42303515	15' Liner Conduit .030-.035" (0.8-0.9mm) Wire Size	
MS42404515	15' Liner Conduit .040-.045" (1.0-1.2mm) Wire Size	
MS42N354515	15' Nylon Conduit .035-.045" (0.9mm-1.2mm) Wire Size	

H Alternative Ends (200 AMP)		
Item Number	Description	
1	MSM20015	Miller® Compatible Back End - 200 Amp 15' Tweco® Style No. 2
1	MSM20025	Miller® Compatible Back End - 200 Amp 25' Tweco® Style No. 2
2	MSL20015N	Lincoln® L3 Compatible Back End - 200 Amp 15' Tweco® Style No. 2
2	MSL20025N	Lincoln® L3 Compatible Back End - 200 Amp 25' Tweco® Style No. 2
3	MSL20015	Lincoln® Compatible Back End - 200 Amp 15' Tweco® Style No. 2
4	MST20015	Tweco® Compatible Back End - 200 Amp 15' Tweco® Style No. 2
5	MSX20015	Euro Compatible Back End - 200 Amp 15' Tweco® Style No. 2

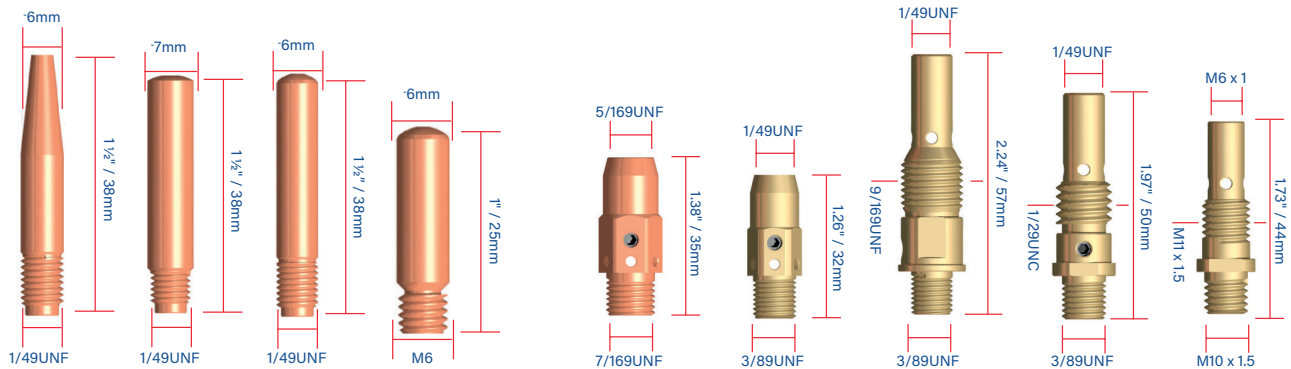

MIG Star™ - No. 4**Air Cooled MIG Welding Gun**Rating: 400A CO₂ 350A mixed gas @ 60% Duty Cycle

EN60974-7 0.0309-5/649/0.8mm-2.0mm wires

TWECO® compatible

**Assembled Stocked Models**

Item Number	Model Description
MST40015	400 AMP TWECO® STYLE TWECO® COMPATIBLE BACK END 15' MIG GUN
MST40025	400 AMP TWECO® STYLE TWECO® COMPATIBLE BACK END 25' MIG GUN
MSM40015	400AMP TWECO® STYLE MILLER® COMPATIBLE BACK END 15' MIG GUN
MSM40025	400 AMP TWECO® STYLE MILLER® COMPATIBLE BACK END 25' MIG GUN
MSM415116	400 AMP TWECO® STYLE/MILLER® COMPATIBLE BACK END 15' MIG GUN WITH 1/16" LINER
MSL40015	400 AMP TWECO® STYLE LINCOLN® COMPATIBLE BACK END 15' MIG GUN
MSL40015N	400 AMP TWECO® STYLE LINCOLN® L3 COMPATIBLE BACK END 15' MIG GUN
MSL40025N	400 AMP TWECO® STYLE LINCOLN® L3 COMPATIBLE BACK END 25' MIG GUN
MSX40015	400 AMP TWECO® STYLE EURO COMPATIBLE BACK END 15' MIG GUN

PACKAGE INCLUDES:

- 400 AMP TWECO® STYLE MIG GUN
- ADJUSTABLE NOZZLE
- ADJUSTABLE NOZZLE INSULATOR
- CONTACT TIP
- GAS DIFFUSER
- CONDUCTOR TUBE
- HANDLE KIT
- TRIGGER SWITCH
- LINER CONDUIT

MIG Star™ - No. 4

Air Cooled MIG Welding Gun

Rating: 400A CO₂ 350A mixed gas @ 60% Duty Cycle
EN60974-7 0.0309-5/649/0.8mm-2.0mm wires

TWECO® compatible

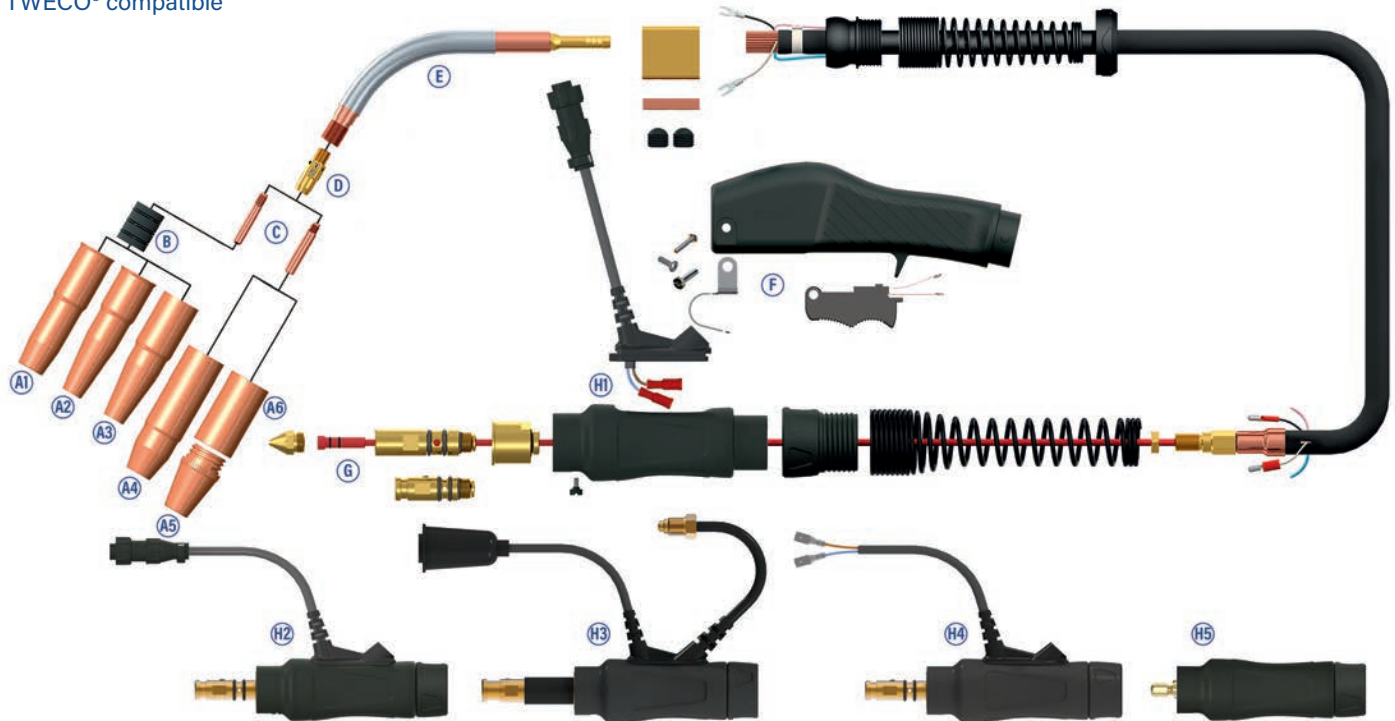

A Nozzles (400 AMP) Sold Separately

Item Number	Description
1 MS24A75	Nozzle Adjustable 3/4" (19mm) use w/34A
2 MS24A50SS	Nozzle Adjustable 1/2" (13mm) Short Stop use w/34A
3 MS23T37	Nozzle Self insulated 3/8" (9.5mm) Tapered
4 MS2337	Nozzle Self insulated 3/8" (9.5mm)
MS24AH75	Nozzle Self insulated 3/4" (19mm)
5 MS24CT62S	Nozzle 5/8" (16mm) Recessed use w/MS34CT
6 MS34CT	Nozzle Insulator w/Coarse Thread Nozzles

B Nozzle Insulator (400 AMP) Sold Separately

Item Number	Description
MS34A	Nozzle Insulator

C Contact Tips (400 AMP) Sold Separately

Item Number	Description
MS14H116	Contact Tip 1/6 (1.6mm) Wire Size
MS14H564	HD Contact Tip 5/64 (2.0mm) Wire Size
MS14HT45	HD Tapered Contact Tip .045" (1.2mm) Wire Size
MS14T116	Tapered Contact Tip 1/16" (1.6mm) Wire Size

D Gas Diffusers (400 AMP)

Item Number	Description
MS54A	Gas Diffuser 1/4UNF Tip Thread
MS55SW	Gas Diffuser 5/16UNF Tip Thread

F Handle Kit & Trigger Switch (400 AMP)

Item Number	Description
MS84HK	Handle Kit c/w Screws and Support
MS94R	Trigger Switch

E Swan Neck Conductor Tubes (400 AMP)

Item Number	Description
MS64J60	60° Conductor Tube
MS64J45	45° Conductor Tube

G Liners (400 AMP)

Item Number	Description
MS44354515	15' Liner Conduit .030-.035" (0.9-1.2mm) Wire Size
MS44354525	25' Liner Conduit .030-.035" (0.9-1.2mm) Wire Size
MS4411615	15' Liner Conduit 1/16" (1.6mm) Wire Size
MS4411625	25' Liner Conduit 1/16" (1.6mm) Wire Size
MS4456415	15' Liner Conduit 5/64" (2.0mm) Wire Size
MS44N11615	15' Nylon Conduit 1/16" (1.6mm) Wire Size
MS44N354515	15' Nylon Conduit .035-.045" (0.9mm-1.2mm) Wire Size

(Continued on next page)

Alternative Ends (400 AMP)		
H	Item Number	Description
1	MSM40015	Miller® Compatible Back End - 400 Amp 15' Tweco® Style No. 2
1	MSM40025	Miller® Compatible Back End - 400 Amp 25' Tweco® Style No. 2
1	MSM415116	Miller® Compatible Back End - 400 Amp 25' Tweco® Style No. 2 with 1/16" Liner
2	MSL40015N	Lincoln® L3 Compatible Back End - 400 Amp 15' Tweco® Style No. 2
2	MSL40025N	Lincoln® L3 Compatible Back End - 400 Amp 25' Tweco® Style No. 2
3	MSL40015	Lincoln® Compatible Back End - 400 Amp 15' Tweco® Style No. 2
4	MST40015	Tweco® Compatible Back End - 400 Amp 15' Tweco® Style No. 2
4	MST40025	Tweco® Compatible Back End - 400 Amp 25' Tweco® Style No. 2
5	MSX40015	Euro Compatible Back End - 400 Amp 15' Tweco® Style No. 2

Additional MIG Star™ Nozzles	
Item Number	Description
MS169715	169-715 Miller® Style Nozzle
MS169724	169-724 Miller® Style Nozzle
MS169725	169-725 Miller® Style Nozzle
MS169726	169-726 Miller® Style Nozzle
MS21T37	21T-37 Tweco® Style Nozzle
MS2262SS	22-62SS Tweco® Style Nozzle - Short Stop
MS2337	23-37 Tweco® Style Nozzle
MS23T37	23T-37 Tweco® Style Nozzle
MS24A50SS	24A-50SS Tweco® Style Nozzle - Short Stop
MSB4391	43-91 Bernard® Style Nozzle
MSB4491	449-1 Bernard® Style Nozzle

Additional MIG Star™ Contact Tips	
Item Number	Description
KR40335	.035" Contact Tip
MS11AH364	Tweco® Style 11-364 Contact Tip
MS14116	Tweco® Style 14-116 Contact Tip
MS14HT45	Tweco® Style 14H-45 HD Tapered Contact Tip
MS11H35	Tweco® Style 11H-35 Contact Tip
MS000067	Miller® Style Contact Tip .030
MS000068	Miller® Style Contact Tip .035
MS000069	Miller® Style Contact Tip .045
MS135424	Miller® Style 135-424 Contact Tip
MS135430	Miller® Style 135-430 Contact Tip
MSB7491	Bernard® Style 74-91 Contact Tip

Additional MIG Star™ Liners	
Item Number	Description
CM24103016	241-03-016 Binzel® Style Liner
KB43115T	44-116-15 Liner
K4411615	15' Liner Assembly
MS354015	35-4015 Tweco® Style Liner
MSB43215	43-215 Bernard® Style Liner

Additional MIG Star™ Gas Diffusers	
Item Number	Description
KR404	R404 Gas Diffusers
MS169728	169-728 Miller® Style Gas Diffusers
MS169729	169-729 Miller® Style Gas Diffusers
MS3550	35-50 Tweco® Style Gas Diffusers
MSB4335	43-35 Bernard® Style Gas Diffusers
MSB4435	44-35 Bernard® Style Gas Diffusers
MSB62A	Bernard® to Tweco® Style #2 Adapter
MSB64A	Bernard® to Tweco® Style #4 Adapter

MIG Star™ Holder



Item Number	Description
MSMIGHOLDER	<ul style="list-style-type: none"> • Magnetic base • Keeps your MIG gun secure when not in use • Works in vertical and horizontal positions • Durable enamel finish with zinc coated base

MIG Star™ MIG Welding Cart

Item Number	Description
MSCYLMIGCART	<ul style="list-style-type: none"> • Easily setup and broken down gives all new meaning to transportable MIG carts • Heavy duty scratch resistant powder coated paint ensures minimal chipping and flaking • Easy quick disconnect wheel replacement ensures minimal downtime





SAND STAR

FOR ALL YOUR WELDING ABRASIVE NEEDS

Cutting Wheels **108-109**

Flap Discs

Jumbo Flap Discs

Grinding Wheels

Stringer Beads **110**

Twist Knot Wheels

Cup Brushes

Crimped End Brushes **111**

Hand Brushes

Files

SAND STAR

Sand Star™ Cutting Wheels



Item Number	Description	Pkg Qty
SS35514	4-1/2" X .045 X 7/8" TYPE 1 .045 CUTTING WHEELS	50

Item Number	Description	Pkg Qty
SS45002	4-1/2" X .045 X 7/8" TYPE 27 .045 CUTTING WHEELS	50
SS45141	4-1/2" X .045 X 5/8-11" TYPE 27 .045 CUTTING WHEELS - HUB	10



Item Number	Description	Pkg Qty
SS35517	6" X .045 X 7/8" TYPE 1 .045 CUTTING WHEELS	50

Item Number	Description	Pkg Qty
SS45007	6" X .045 X 7/8" TYPE 27 .045 CUTTING WHEELS	50
SS45143	6" X .045 X 5/8-11" TYPE 27 .045 CUTTING WHEELS - HUB	10

Sand Star™ Flap Discs



Item Number	Description	Pkg Qty
SS42322	4-1/2 X 7/8 FLAP DISC 40 GRIT TYPE 29 REG. DENSITY	10
SS42332	4-1/2 X 5/8-11 FLAP DISC 40 GRIT TYPE 29 REG. DENSITY - HUB	10

Item Number	Description	Pkg Qty
SS42324	4-1/2 X 7/8 FLAP DISC 60 GRIT TYPE 29 REG. DENSITY	10
SS42334	4-1/2 X 5/8-11 FLAP DISC 60 GRIT TYPE 29 REG. DENSITY - HUB	10

Item Number	Description	Pkg Qty
SS42325	4-1/2 X 7/8 FLAP DISC 80 GRIT TYPE 29 REG. DENSITY	10
SS42335	4-1/2 X 5/8-11 FLAP DISC 80 GRIT TYPE 29 REG. DENSITY - HUB	10

(Continued on next page)

Sand Star™ Flap Discs & Jumbo Flap Discs



Item Number	Description	Pkg Qty
SS42326	4-1/2" X 7/8" FLAP DISC 120 GRIT TYPE 29 REG. DENSITY	10
SS42336	4-1/2" X 5/8-11" FLAP DISC 120 GRIT TYPE 29 REG. DENSITY - HUB	10



Item Number	Description	Pkg Qty
SS42362	4-1/2" X 7/8" JUMBO FLAP DISC 40 GRIT	10
SS42372	4-1/2" X 5/8-11" JUMBO FLAP DISC 40 GRIT - HUB	10



Item Number	Description	Pkg Qty
SS42364	4-1/2" X 7/8" JUMBO FLAP DISC 60 GRIT	10
SS42374	4-1/2" X 5/8-11" JUMBO FLAP DISC 60 GRIT - HUB	10



Item Number	Description	Pkg Qty
SS42365	4-1/2" X 7/8" JUMBO FLAP DISC 80 GRIT	10
SS42375	4-1/2" X 5/8-11" JUMBO FLAP DISC 80 GRIT - HUB	10



Item Number	Description	Pkg Qty
SS42366	4-1/2" X 7/8" JUMBO FLAP DISC 120 GRIT	10
SS42376	4-1/2" X 5/8-11" JUMBO FLAP DISC 120 GRIT - HUB	10

Sand Star™ Grinding Wheels



Item Number	Description	Pkg Qty
SS35620	4-1/2" X 1/4" X 7/8" GRINDING WHEELS	25
SS35621	4-1/2" X 1/4" X 5/8-11" GRINDING WHEELS - HUB	10



Item Number	Description	Pkg Qty
SS35640	7" X 1/4" X 7/8" GRINDING WHEELS	15
SS35641	7" X 1/4" X 5/8-11" GRINDING WHEELS - HUB	10



STRINGER BEADS

Part Number	Diameter	Wire Size	Arbor Hole or Nut	No. of Knots	Trim Length	Face Width	Max RPM	Carbon Steel or Stainless	Standard Pack
*SS4WS075	4"	.020"	5/8"-11 Nut	30	7/8"	5/16"	20,000	Carbon Steel	12
*SS4WS075SS	4"	.020"	5/8"-11 Nut	30	7/8"	5/16"	20,000	Stainless	12
*SS6WS1	6"	.020"	5/8"-11 Nut	48	1-1/4"	5/16"	12,000	Carbon Steel	10
*SS6WS1SS	6"	.020"	5/8"-11 Nut	48	1-1/4"	5/16"	20,000	Stainless	10
SS7WS15	7"	.020"	5/8"-11 Nut	48	1-1/2"	5/16"	9,000	Carbon Steel	10
SS7WS16	7"	.020"	5/8"-11 Nut	56 knots	1-1/2"	5/16"	9,000	Carbon Steel	10

TWIST KNOT WHEELS

Part Number	Diameter	Wire Size	Arbor Hole or Nut	No. of Knots	Trim Length	Face Width	Max RPM	Carbon Steel or Stainless	Standard Pack
SS4WK625	4"	.014"	5/8"-11 Nut	20	3/4"	1/2"	20,000	Carbon Steel	10
SS4WK625SS	4"	.014"	5/8"-11 Nut	20	3/4"	1/2"	20,000	Stainless	10
SS4WK625SS020	4"	.020"	5/8"-11 Nut	20	3/4"	1/2"	20,000	Stainless	10

CUP BRUSHES

Part Number	Diameter	Wire Size	Arbor Hole or Nut	No. of Knots	Trim Length	Max RPM	Carbon Steel or Stainless	Standard Pack
*SS275CK1	2-3/4"	.020"	5/8"-11 Nut	20	1"	14,000	Carbon Steel	6
*SS275CK1SS	2-3/4"	.020"	5/8"-11 Nut	20	1"	14,000	Stainless	6
SS3CK875	3"	.020"	5/8"-11 Nut	20	7/8"	12,500	Carbon Steel	6
SS4CK125	4"	.020"	5/8"-11 Nut	20	1-1/8"	9,000	Carbon Steel	10

*Product Made in USA



CRIMPED END BRUSHES

Part Number	Diameter	Wire Size	Stem Size	Trim Length	Max RPM	Carbon Steel or Stainless	Standard Pack
SS05EC1	1/2"	.014"	1/4"	1"	20,000	Carbon Steel	75
SS05EC1SS	1/2"	.014"	1/4"	1"	20,000	Stainless	75
SS075CC875	3/4"	.014"	1/4"	7/8"	20,000	Carbon Steel	50
SS075CC875SS	3/4"	.014"	1/4"	7/8"	20,000	Stainless	50
SS1CC1	1"	.014"	1/4"	1"	20,000	Carbon Steel	35

HAND BRUSHES & FILES

Part Number	Description	Standard Pack	Part Number	Description	Standard Pack
SS85045	3 x 19 Carbon Steel scratch brush, 13-1/4 x 7/8	12	SS85055	3 x 7 Stainless Steel toothbrush, wooden handled	25
SS85047	3 x 19 Stainless Steel scratch brush, 13-1/4 x 7/8	12	SS85056	3 x 7 Brass toothbrush, wooden handled	25
SS85051	4 x 16 Carbon Steel scratch brush, shoe handled	12	SS85056P	3 x 7 Brass toothbrush, plastic handled	25
SS85053	4 x 16 Stainless Steel scratch brush, shoe handled	12	SS14HRB	Premium 14" Half Round Bastard File	1

ADDITIONAL SAND STAR™ PRODUCTS

Part Number	Description	Part Number	Description
TW51471808RA	4X020SSX5/8-11 STRINGER - BEAD STAINLESS	TW56322171	4X5/8-11 CRIMPED WIRE WHEEL
TW51474808	6X020SSX5/8-11 STRINGER BEAD - STAINLESS	TW55424178	3-1/2X5/8-11 .014 CRIMPED CUP BRUSH - STEEL
TW51475808	7X020SSX5/8-11 STRINGER BEAD - STAINLESS	TW55429198	6X5/8-11 CUP BRUSH - CARBON STEEL
TW51471809	4X020SSX3/8-24 STRINGER BEAD BRUSH	TW54485238	3-1/2X5/8-11 .020 KNOT CUP - STEEL
TW52471118	4X014X5/8-11 KNOT WHEEL - CARBON STEEL	TW54486818	4X5/8-11 .020 KNOT CUP - STAINLESS
TW52471218	4X020X5/8-11 KNOT WHEEL - CARBON STEEL	TW54487318	5X020X5/8-11 KNOT CUP - CARBON STEEL
TW52471211	4X7/8 7/8 .020 KNOT WHEEL STANDARD - ARBOR STEEL	TW53472858	4-1/2X020SSX5/8-11 KNOT CONICAL - STAINLESS
TW52472218	4-1/2X5/8-11 KNOT WHEEL - STEEL	TW56415163	2X.014X1/4 SHANK CRIMPED WIRE BRUSH
TW52474211	6X7/8 7/8 .020 KNOT WHEEL STANDARD - ARBOR STEEL	TW56415362	2X012SSX1/4 SHANK CRIMPED WHEEL BRUSH - STAINLESS
TW52474818	6X5/8-11 .020 KNOT WHEEL STANDARD - STAINLESS	TW59103741	4X15 .014 HAND BRUSH - STAINLESS



SOUTHERN
G L O V E

A Brand of

TECHNIWELDUSA

DESIGNED TO PROTECT, MANUFACTURED TO LAST

Leather Gloves	113-115
Single Palm Gloves	115-116
Jersey Gloves	116
Chore Gloves	116
Double Palm Gloves	117
Oil Field Gloves	118
Hot Mill Gloves	118-121
Flame Retardant Gloves	121
Impact Gloves	122-124
Machine Knit Gloves	124
Palm Dip Gloves	124-125
Cut Resistant Knit Gloves	125
Coated Gloves	125
Terry Cloth Gloves	126
Disposable Gloves	126
Sleeves	127-128
Aprons	128
Protective Apparel	129





Leather Gloves

Used in construction, machine operation, light duty welding, utility work, farming, roping and many other general applications.

Leather offers excellent protection for abrasion and cuts. It also is breathable and comfortable at an economical price. Southern Glove offers an array of leathers and options to suit most applications. Goat Skin - A strong, durable and soft leather with great abrasion resistance. Lanolin in the goat hide helps keep the hands soft and comfortable during those all day jobs. Pigskin - A very soft leather that withstands moisture better than other types of leather. Split Leather - This leather is the hide that is "underneath" the grain, "split" from the top leather. It is considered the premier grade of leather. Cowhide - A comfortable, durable, breathable leather with excellent abrasion resistance.

Leather Welding Gloves

Item Number	Description	Sizes	Color	Pkg Qty	Case Qty
IBWFL	BLUE LEATHER WELDER, FOAM LINED, REINFORCED THUMB & PALM, KEVLAR® SEWN	L	BLUE	12 PR	36 PR
GOOD	Similar to AG1080 - STICK WELDING GLOVES	L - XL	BLUE	12 PR	
	Features: <ul style="list-style-type: none"> • Single piece back • True pearl blue leather color • Shoulder split cowhide • 14" length 		<ul style="list-style-type: none"> • DuPont™ Kevlar® stitching for enhanced strength and protection • Continuous welted fingers to protect stitching • Inside cotton lined to provide a comfortable work environment 		
IGW	SPLIT LEATHER WELDER, COTTON LINED	L	GRAY	12 PR	72 PR
GOOD	Similar to AG1000 STICK WELDING GLOVES	L - XL	GRAY	12 PR	
	Features: <ul style="list-style-type: none"> • Single piece back • True pearl leather color • Shoulder split cowhide • 14" length 		<ul style="list-style-type: none"> • DuPont™ Kevlar® stitching for enhanced strength and protection • Continuous welted fingers to protect stitching • Inside cotton lined to provide a comfortable work environment 		
TIGW4	GOATSKIN TIG WELDER-4 BLUE SPLIT COWHIDE GAUNTLET	L-XL	WHITE/BLUE	12 PR	120 PR
GOOD	Similar to AG1338 TIG WELDING GLOVES	S - XL	WHITE/GOLDEN BROWN	12 PR	
	Features: <ul style="list-style-type: none"> • Premium goat skin leather provides great feel and dexterity • Straight thumb provides enhanced grip • Reinforced thumb provides protection where it's needed most • Glide patch provides side protection 		<ul style="list-style-type: none"> • 4" split cuff provides added protection • DuPont™ Kevlar® stitching provides enhanced strength and protection • Goat skin has a natural lanolin content that keeps gloves and hands soft 		
UW59K9FRBT	GREY COWHIDE LEATHER PALM AND THUMB, 10 OZ. SEAL BROWN FLAME RETARDED FINGERS AND BAND TOP	L	MULTI COLOR	12 PR	72 PR
GOOD					



IBWFL



IGW



TIGW4



ABSBDWTK



ALDWTk







ATLLDWTk

Leather Drivers Gloves

Item Number	Description	Sizes	Color	Pkg Qty	Case Qty
ABSBDWTK	LEATHER DRIVER, PREMIUM A+ GRADE COW GRAIN, UNLINED, WING THUMB, BROWN SHOULDER SPLIT BACK, SHIRRED ELASTIC, ROLLED CUFF, SIZE INDICATING COLOR LABEL SEWN INTO SIDE SEAM, SEWN WITH KEVLAR® THREAD	XS-3XL	NATURAL	12 PR	120 PR
BETTER					
ALDWTk	LEATHER DRIVER, PREMIUM A+ INDUSTRIAL GRADE COW GRAIN, UNLINED, WING THUMB, SHIRRED ELASTIC, ROLLED CUFF, SEWN WITH KEVLAR® THREAD	XS-3XL	WHITE	12 PR	120 PR
BETTER	Similar to AG1424 DRIVERS GLOVES	M - XL	WHITE	12 PR	
	Features: <ul style="list-style-type: none"> • Premium cowhide leather provides great tensile strength and abrasion resistance • Keystone thumb provides comfortable fit • Forefingers are double stitched for extra strength 		<ul style="list-style-type: none"> • Unlined • Premium rolled leather cuff • Gunn cut 		
ARLLDWTk	LEATHER DRIVER, PREMIUM A+ INDUSTRIAL GRADE COW GRAIN, RED FLEECE LINER, WING THUMB, SHIRRED ELASTIC, ROLLED CUFF, SEWN WITH KEVLAR® THREAD	XS-2XL	NATURAL	12 PR	120 PR
BETTER					
ATLLDWTk	LEATHER DRIVER, PREMIUM A+ INDUSTRIAL GRADE COW GRAIN, THINSULATE® LINER, WING THUMB, SHIRRED ELASTIC, ROLLED CUFF, SEWN WITH KEVLAR® THREAD	XS-3XL	NATURAL	12 PR	120 PR
BETTER					

Leather Drivers Gloves

Item Number	Description	Sizes	Color	Pkg Qty	Case Qty
AYSBDKTK	LEATHER DRIVER, A+ GRADE COW GRAIN, UNLINED, KEYSTONE THUMB, GOLDEN SHOULDER SPLIT BACK, SHIRRED ELASTIC, ROLLED CUFF, SIZE INDICATING COLOR LABEL SEWN INTO SIDE SEAM, SEWN WITH KEVLAR® THREAD	XS-3XL	NATURAL	12 PR	120 PR
BETTER	Similar to AG1414 DRIVERS GLOVES	S - XL	WHITE/ GOLDEN BROWN	12 PR	
	Features: <ul style="list-style-type: none"> - Contoured to fit the natural shape of your hand - DuPont™ Kevlar® stitching for enhanced strength and protection - Scotch colored cowhide split leather back - Keystone style thumb design - Super duty palm made of top grain pearl cowhide - Unlined to enhance feel and dexterity 				
FPA3LDK	A/B GRADE COWHIDE LEATHER DRIVER, KEYSTONE THUMB, FULL PARA-ARAMID/ GLASS LINING WITH ANSI 105 A3 RATING, SHIRRED ELASTIC BACK	L-XL	NATURAL	12 PR	120 PR
BETTER					
FPA3LDK	A/B GRADE COWHIDE LEATHER DRIVER, KEYSTONE THUMB, FULL PARA-ARAMID/ GLASS LINING WITH ANSI 105 A3 RATING, SHIRRED ELASTIC BACK	L-XL	NATURAL	12 PR	120 PR
BETTER	Similar to AG1415A3 DRIVERS GLOVES	M-XL	WHITE	12 PR	
	Features: <ul style="list-style-type: none"> - Premium top grain goatskin construction for the best dexterity - Premium goatskin leather offers ANSI 105 Level 3 Cut Protection and Abrasion Resistance - Color coded hem for each size - DuPont™ Kevlar® stitching for enhanced strength and protection - Keystone thumb provides comfortable fit - Goat skin has a natural lanolin content that keeps gloves and hands soft - Elastic back and wrist provides secure fit 				
FPA3TPRLDK	A/B GRADE COWHIDE LEATHER DRIVER, KEYSTONE THUMB, ORANGE TPR IMPACT PROTECTION, FULL PARA-ARAMID/GLASS LINING WITH ANSI 105 A3 RATING, SHIRRED ELASTIC BACK	L-XL	NATURAL	12 PR	120 PR
BETTER					
GLDK	LEATHER DRIVER, A/B INDUSTRIAL GRADE GOAT GRAIN, UNLINED, KEYSTONE THUMB, SHIRRED ELASTIC	S-2XL	WHITE	12 PR	120 PR
GOOD	Similar to AG1415 DRIVERS GLOVES	S-2XL	WHITE	12 PR	
	Features: <ul style="list-style-type: none"> - Premium goat skin leather provides great feel and dexterity - Abrasion resistant - Goat skin has a natural lanolin content that keeps gloves and hands soft - Elastic back at wrist provides secure fit - Keystone thumb provides comfortable fit - Color coded hem for each size 				
GLDKA6	A/B GRADE GOATSKIN LEATHER DRIVER, KEYSTONE THUMB, ANSI 105 A6 ARAMID LINER, SHIRRED ELASTIC BACK	M, 3XL	WHITE	12 PR	120 PR
BETTER					
LDK	LEATHER DRIVER, INDUSTRIAL GRADE COW GRAIN, UNLINED, KEYSTONE THUMB, SHIRRED ELASTIC	S-3XL	NATURAL	12 PR	120 PR
GOOD	Similar to AG1420 DRIVERS GLOVES	S-3XL	NATURAL	12 PR	
	Features: <ul style="list-style-type: none"> - Premium pearl top grain cowhide - Gunn cut - Unlined - Leather rolled cuff - Straight thumb for the best grip - Added strength derived from double stitching on forefinger 				
LDKTPR	LEATHER DRIVER, INDUSTRIAL GRADE COW GRAIN, UNLINED, KEYSTONE THUMB, SHIRRED ELASTIC, TPR BACK	M-XL	NATURAL	12 PR	120 PR
GOOD					
LDKWYH	LEATHER DRIVER, A/B INDUSTRIAL GRADE COW GRAIN, UNLINED, KEYSTONE THUMB, ORANGE FINGER TIPS, WATCH YOUR HANDS PRINTED ON BACK, SHIRRED ELASTIC	S-3XL	NATURAL	12 PR	120 PR
GOOD					
LDWT	LEATHER DRIVER, A/B INDUSTRIAL GRADE COW GRAIN, UNLINED, WING THUMB, SHIRRED ELASTIC	S-3XL	NATURAL	12 PR	120 PR
GOOD					
PLDK	LEATHER DRIVER, INDUSTRIAL GRADE PIG GRAIN, UNLINED, KEYSTONE THUMB, SHIRRED ELASTIC	S-XL	NATURAL	12 PR	120 PR
GOOD					
RLLDK	LEATHER DRIVER, A/B INDUSTRIAL GRADE COW GRAIN, RED FLEECE LINER, KEYSTONE THUMB, SHIRRED ELASTIC	S-3XL	NATURAL	12 PR	120 PR
GOOD					
SBLDK	LEATHER DRIVER, A/B INDUSTRIAL GRADE COW GRAIN, REGULAR GRADE SPLIT BACK, UNLINED, KEYSTONE THUMB, SHIRRED ELASTIC	S-2XL	NATURAL	12 PR	120 PR
GOOD					



AYSBDKTK



GLDK



GLDKA6



LDK





LDKWYH



LDWT



Leather Work Gloves

Item Number	Description	Sizes	Color	Pkg Qty	Case Qty
GOOD	AG1525 WORK GLOVES	S-3XL	MULTI COLOR	12 PR	
	Features: • Professional, affordable work glove • Gunn cut with 2" rubberized safety cuff and canvas backing • Rugged, side-split cowhide palm and knuckle strap				
BETTER	AG1515B WORK GLOVES	L-XL	MULTI COLOR	12 PR	
	Features: • Ideal high-end work glove • Gunn cut style glove with 2" rubberized safety cuff and a canvas back • Shoulder split cowhide, double palm, and knuckle strap • Double palmed for additional palm protection to key areas • DuPont™ Kevlar® stitching for enhanced strength and protection				
IW59 GOOD	SPLIT LEATHER PALM, CANVAS BACK, SPLIT LEATHER TIPS, FOREFINGER, KNUCKLE STRAP, SHIRRED ELASTIC, SAFETY CUFF	L & XL	MULTI COLOR	12 PR	120 PR
IW59A6 GOOD	SPLIT LEATHER PALM, FOREFINGER AND FINGERTIPS, ANSI 105 A6 ARAMID LINER, CANVAS BACK, KNUCKLE STRAP, SHIRRED ELASTIC, SAFETY CUFF	L-XL	MULTI COLOR	12 PR	120 PR



Leather Mechanics Gloves

Item Number	Description	Sizes	Color	Pkg Qty	Case Qty
MECHBK GOOD	MECHANICS GLOVE, SYNTHETIC LEATHER PALM, BREATHABLE STRETCH BACK, ELASTIC CUFF, VELCRO CLOSE	S-2XL	BLACK	12 PR	72 PR
MG9011 BETTER	PREMIUM A+ GRADE TAN GOATSKIN PALM AND BACK OF INDEX FINGER THUMB AND FINGER TIPS, REINFORCED THUMB CROTCH, PALM PATCHES, BLACK LYCRA FOURCHETTES, BLACK LAMINATED FOUR-WAY STRETCH LYCRA BACK, 5MM BLACK TPR, VELCRO CLOSURE, NAME TAG	M-XL	RED	12 PR	72 PR



Single Palm Gloves

Ideal for the petrochemical, gas and oil industries. Great for most light duty work situations such as general industrial work, agriculture, construction, material handling, and gardening/outdoor uses.

Designed to maximize comfort for light duty work, Single Palms are constructed of breathable 100% cotton or poly cotton material. Wrist options include band top, gauntlet or knit wrist.

Item Number	Description	Sizes	Color	Pkg Qty	Case Qty
I83	LIGHT WEIGHT, STANDARD GRADE, 70% COTTON, 30% POLYESTER, KNIT WRIST CUFF	L	NATURAL	12 PR	300 PR
I8EGXB	LIGHT WEIGHT, STANDARD GRADE, 100% COTTON, NATURAL EXTERNAL ELASTIC, RUBBERIZED GAUNTLET WITH RED BINDING	L	NATURAL	12 PR	144 PR
IPD83	LIGHT WEIGHT, STANDARD GRADE, NATURAL CANVAS, BLACK PVC DOTTED PALM, NATURAL KNIT WRIST	L	NATURAL	12 PR	300 PR
ISD83	LIGHT WEIGHT, STANDARD GRADE, NATURAL CANVAS, ORANGE PVC DOTTED PALM, NATURAL KNIT WRIST	L	WHITE	12 PR	300 PR
U83	LIGHT WEIGHT, PREMIUM GRADE, 100% COTTON, 100% COTTON NATURAL KNIT WRIST	S, L	NATURAL	12 PR	144 PR
U84	LIGHT WEIGHT, PREMIUM GRADE, 100% COTTON, 100% COTTON NAVY KNIT WRIST	L	NATURAL	12 PR	144 PR
U8BT	LIGHT WEIGHT, PREMIUM GRADE, 100% COTTON, BAND TOP CUFF	S, L, XL	NATURAL	12 PR	144 PR
Item Number	Description	Sizes	Color	Pkg Qty	Case Qty
IGPD109	MEDIUM WEIGHT, STANDARD GRADE, GREEN CANVAS, BLACK PVC DOTTED PALM, MATCHING KNIT WRIST	L	GREEN	12 PR	300 PR
IOPD107	MEDIUM WEIGHT, STANDARD GRADE, ORANGE CANVAS, BLACK PVC DOTTED PALM, MATCHING KNIT WRIST	L	ORANGE	12 PR	300 PR
UI03	MEDIUM WEIGHT, PREMIUM GRADE, 100% COTTON, 100% COTTON NATURAL KNIT WRIST	S, 2XL	NATURAL	12 PR	144 PR



(Continued on next page)

Single Palm Gloves



ULG



UPC503R



U12DG



U1052



UJ83



U2199

Item Number	Description	Sizes	Color	Pkg Qty	Case Qty
ULG	MEDIUM WEIGHT, PREMIUM GRADE, POLY/CORD, BLACK EXTERNAL ELASTIC, BAND TOP CUFF, DOUBLE STITCHED	S-2XL	NATURAL	12 PR	144 PR
UPC103	MEDIUM WEIGHT, PREMIUM GRADE, POLY/COTTON, 100% COTTON NATURAL KNIT WRIST	S, L, XL	NATURAL	12 PR	144 PR
UPC10BT	MEDIUM WEIGHT, PREMIUM GRADE, POLY/COTTON, BAND TOP CUFF	XL	WHITE	12 PR	144 PR
UPC503R	MEDIUM WEIGHT, PREMIUM GRADE, CORDED POLY/COTTON, REVERSIBLE, 100% COTTON NATURAL KNIT WRIST	L	NATURAL	12 PR	144 PR
UPC503	MEDIUM WEIGHT, PREMIUM GRADE, CORDED POLY/COTTON, 100% COTTON NATURAL KNIT WRIST	S, L	NATURAL	12 PR	144 PR
UPC58EBTX	MEDIUM WEIGHT, PREMIUM GRADE, CORDED POLY/COTTON, RED ELASTIC, CORDED POLY/COTTON BAND TOP CUFF	XL	NATURAL	12 PR	144 PR
UPD10BT	MEDIUM WEIGHT, PREMIUM GRADE, BLACK PVC DOTS, BAND TOP CUFF	S, 3XL	NATURAL	12 PR	144 PR
UPD10EXSC	MEDIUM WEIGHT, PREMIUM GRADE, BLACK PVC DOTS, EXTERNAL ELASTIC, SAFETY CUFF	XL	NATURAL	12 PR	144 PR
UPD10SC	MEDIUM WEIGHT, PREMIUM GRADE, BLACK PVC DOTS, SAFETY CUFF	L	NATURAL	12 PR	144 PR
UTDWB	MEDIUM WEIGHT, PREMIUM GRADE, TAN PVC DASH PALM, BAND TOP CUFF	L	TAN	12 PR	144 PR

Item Number	Description	Sizes	Color	Pkg Qty	Case Qty
I123	HEAVY WEIGHT, STANDARD GRADE, 70% COTTON, 30% POLYESTER, NATURAL KNIT WRIST	S, L	NATURAL	12 PR	144 PR
I12BT	HEAVY WEIGHT, STANDARD GRADE, 70% COTTON, 30% POLYESTER, BAND TOP CUFF	L	NATURAL	12 PR	144 PR
U123	HEAVY WEIGHT, PREMIUM GRADE, 100% COTTON, 100% COTTON KNIT WRIST	S-2XL	NATURAL	12 PR	144 PR
U125	HEAVY WEIGHT, PREMIUM GRADE, 70% COTTON, 30% POLYESTER, RED KNIT WRIST	L	NATURAL	12 PR	144 PR
U12DG	HEAVY WEIGHT, PREMIUM GRADE, 70% POLYESTER 30% COTTON, DUCK GAUNTLET CUFF	L-2XL	NATURAL	12 PR	144 PR
UMW10E	HEAVY WEIGHT, PREMIUM GRADE, 100% COTTON, RED ELASTIC, 100% COTTON RED KNIT WRIST	L	NATURAL	12 PR	144 PR

Item Number	Description	Sizes	Color	Pkg Qty	Case Qty
UK9FRBT	100% ARAMID PALM, FLAME RESISTANT OLIVE DRAB FINGERS AND BAND TOP CUFF	L	YELLOW	12 PR	144 PR
UK9RBT	100% ARAMID JERSEY, REVERSIBLE, NATURAL COTTON BAND TOP CUFF	L	YELLOW	12 PR	144 PR

Jersey Gloves

These gloves are designed for light industrial work. Jersey's are made from soft knitted cotton or poly cotton fabrics and stretch for a comfortable fit. Available in a variety of sizes, these gloves come with a knit wrist cuff for a snug fit.

Great for outdoor general purpose work such as farming, cleaning, digging, paving, machinery operation, mowing and maintenance.

Item Number	Description	Sizes	Color	Pkg Qty	Case Qty
I92	MEDIUM WEIGHT, STANDARD GRADE, COTTON/SYNTHETIC BROWN JERSEY, BROWN KNIT WRIST	L	BROWN	12 PR	300 PR
U92	MEDIUM WEIGHT, PREMIUM GRADE, 100% COTTON BROWN JERSEY, BROWN KNIT WRIST	S, L, XL	BROWN	12 PR	144 PR
UJ83	MEDIUM WEIGHT, PREMIUM GRADE, 100% COTTON NATURAL JERSEY, NATURAL KNIT WRIST	L	NATURAL	12 PR	144 PR
U1052	HEAVY WEIGHT, PREMIUM GRADE, BROWN JERSEY, BROWN KNIT WRIST	L-XL	BROWN	12 PR	144 PR
I14LJ	EXTRA HEAVY WEIGHT, STANDARD GRADE, 100% COTTON RED-LINED BROWN JERSEY, SLIP ON PATTERN	L	BROWN	12 PR	120 PR

Chore Gloves

Ideal for industrial work, Chore gloves come in a variety of medium and heavyweight styles for all seasons. Styles are available in golden brown or green and come with a second layer of fleece lining for cold environments. Double palms are available when extra hand protection is required. Knit wrists fit snugly and protect the hand from debris and dirt.

Item Number	Description	Sizes	Color	Pkg Qty	Case Qty
UFS2307	MEDIUM WEIGHT, PREMIUM GRADE, GOLDEN BROWN COTTON OUTER, NONWOVEN LINER, MATCHING KNIT WRIST	S-L	GOLDEN BROWN	12 PR	144 PR
UFS2300	MEDIUM WEIGHT, PREMIUM GRADE, GOLDEN BROWN COTTON OUTER, NONWOVEN LINER, BLUE KNIT WRIST	L	GOLDEN BROWN	12 PR	144 PR
U2199	HEAVY WEIGHT, 100% DOUBLE WOVEN COTTON, 100% COTTON KNIT WRIST	L-2XL	GREEN	12 PR	144 PR

Double Palm Gloves

Double Palms provide an extra layer of palm protection. Available in natural and golden brown, 100% cotton and poly cotton, from medium to extra heavy weight construction. These gloves are ideal for industrial, agricultural or construction applications. Options include: Rubberized gauntlets, safety cuffs, band tops, knit wrists and external elastic. The back features a single layer of cotton to protect hands without overheating them.

Ideal for general industrial work, agricultural, construction, heavy duty applications, material handling, automotive, machine shops and foundry applications.

Item Number	Description	Sizes	Color	Pkg Qty	Case Qty
ULF16WBT	PREMIUM GRADE, LIGHT WEIGHT, COTTON AND NONWOVEN LINER PALM, NAP IN, BAND TOP CUFF	L	NATURAL	12 PR	144 PR
U18G	PREMIUM GRADE, GOLDEN BROWN PALM, 100% COTTON, RUBBERIZED GAUNTLET CUFF	L	GOLDEN BROWN	12 PR	72 PR
U18SG	PREMIUM GRADE, GOLDEN BROWN PALM, 100% COTTON, STARCHED GAUNTLET CUFF	L	GOLDEN BROWN	12 PR	72 PR
UHF183	PREMIUM GRADE, COTTON AND NONWOVEN LINER PALM, NAP IN, 100% COTTON NATURAL KNIT WRIST	L	NATURAL	12 PR	144 PR
UHF183NO	PREMIUM GRADE, COTTON AND NONWOVEN LINER PALM, NAP OUT, 100% COTTON NATURAL KNIT WRIST	L	NATURAL	12 PR	144 PR
UHF181	PREMIUM GRADE, GOLDEN BROWN COTTON AND NONWOVEN LINER PALM, NATURAL FINGERS, NATURAL KNIT WRIST	L	GOLDEN BROWN	12 PR	144 PR
UHF18BT	PREMIUM GRADE, GOLDEN BROWN COTTON AND NONWOVEN LINER PALM, NATURAL FINGERS, BAND TOP CUFF	L	GOLDEN BROWN	12 PR	144 PR
UHF18WBDT	PREMIUM GRADE, NATURAL COTTON AND NONWOVEN LINER PALM, NAP OUT, BAND TOP CUFF DOUBLE SEWN TO GLOVE	L	NATURAL	12 PR	144 PR
UCHF18WDG	PREMIUM GRADE, CORDED POLY/COTTON OUTER, NONWOVEN LINER, DUCK GAUNTLET CUFF	L-XL	NATURAL	12 PR	72 PR
UHF18WBT	PREMIUM GRADE, NATURAL COTTON AND NONWOVEN LINER PALM, NAP IN, BAND TOP CUFF	S, L	NATURAL	12 PR	144 PR
UHF18WDG8D	PREMIUM GRADE, NATURAL COTTON AND NONWOVEN LINER PALM, NAP OUT, 8" DUCK GAUNTLET DOUBLE SEWN TO GLOVE	L	NATURAL	12 PR	72 PR
UHF18WTNESC	PREMIUM GRADE, NATURAL COTTON AND NONWOVEN LINER PALM, NATURAL FINGERS WITH RED ELASTIC, NATURAL TURTLENECK, NAP IN, SAFETY CUFF	L	WHITE	12 PR	72 PR
UHF18SC	PREMIUM GRADE, GOLDEN BROWN COTTON AND NONWOVEN LINER PALM, NATURAL FINGERS, BAND TOP CUFF	L	GOLDEN BROWN	12 PR	144 PR
UHF18TNESC	PREMIUM GRADE, GOLDEN BROWN COTTON AND NONWOVEN LINER PALM, NATURAL FINGERS WITH RED ELASTIC, GOLDEN BROWN TURTLENECK, SAFETY CUFF	L	GOLDEN BROWN	12 PR	72 PR
UHF20TNESC	HEAVY-WEIGHT PREMIUM GRADE, GOLDEN BROWN COTTON AND NONWOVEN LINER PALM, NATURAL FINGERS WITH RED ELASTIC, GOLDEN BROWN TURTLENECK, SAFETY CUFF	L	BROWN	12 PR	72 PR
UPC193	PREMIUM-GRADE, DOUBLE PALM, POLY/COTTON OUTER, NONWOVEN LINER, NATURAL KNIT WRIST	L	NATURAL	12 PR	144 PR



U18G



UHF181



UHF18WBT



IDHCHF183



I183



ICHF185

Oil Field Gloves

Ideal for the petrochemical, gas and oil industries, Southern Glove is best known in the drilling industry for its durable "Super Oil Rig" glove. Constructed of poly cotton, cotton twill, corded outers and non-woven liners, Oil Field gloves are available in a variety of cuffs, high visibility color combinations, palm patterns and weights.

Item Number	Description	Sizes	Color	Pkg Qty	Case Qty
UPD103	MEDIUM WEIGHT, BLACK PVC DOTS, 100% COTTON NATURAL KNIT WRIST	S, L, XL	NATURAL	12 PR	144 PR
USD103	MEDIUM WEIGHT, ORANGE PVC DOTS, 100% COTTON NATURAL KNIT WRIST	L	NATURAL	12 PR	144 PR
I183	DOUBLE PALM, STANDARD GRADE, 100% COTTON OUTER, NAP IN, NATURAL KNIT WRIST	L	NATURAL	12 PR	144 PR
I185	DOUBLE PALM, STANDARD GRADE, 100% COTTON OUTER, NAP IN, RED KNIT WRIST	L	NATURAL	12 PR	144 PR
WI185	ECONOMY GRADE, 100% COTTON OUTER, NAP IN, RED KNIT WRIST	L	NATURAL	12 PR	144 PR
U183	PREMIUM GRADE, NATURAL 100% COTTON OUTER, NAP IN, NATURAL KNIT WRIST	L	NATURAL	12 PR	144 PR

Oil Field Gloves

Item Number	Description	Sizes	Color	Pkg Qty	Case Qty
WICHF183	STANDARD GRADE, CORDED POLY/COTTON OUTER, NONWOVEN LINER, NATURAL KNIT WRIST	L	NATURAL	12 PR	144 PR
ICHF183	DOUBLE PALM, STANDARD GRADE, CORDED POLY/COTTON OUTER, NONWOVEN LINER, NATURAL KNIT WRIST	L-XL	NATURAL	12 PR	144 PR
ICHF185	DOUBLE PALM, STANDARD GRADE, CORDED POLY/COTTON OUTER, NONWOVEN LINER, RED KNIT WRIST	L	NATURAL	12 PR	144 PR
ICHF18WSC	STANDARD GRADE, CORDED POLY/COTTON OUTER, NONWOVEN LINER, SAFETY CUFF	L	NATURAL	12 PR	144 PR
IWCHF183	STANDARD GRADE, CORDED POLY/COTTON OUTER, NON-WOVEN LINER, WING THUMB, NATURAL KNIT WRIST	L	NATURAL	12 PR	144 PR
IWCHF18WSC	POLY/COTTON OUTER HEAVY WEIGHT, CORDED POLY/COTTON OUTER, NONWOVEN LINER, SAFETY CUFF, WING THUMB	L	NATURAL	12 PR	144 PR
IDHCHF183	STANDARD GRADE, CORDED POLY/COTTON OUTER, WATERPROOF BREATHABLE HIPORA® AND JERSEY LINERS, NATURAL KNIT WRIST	L	NATURAL	12 PR	144 PR
ICHF18FYPD	DOUBLE PALM, STANDARD GRADE, FLUORESCENT YELLOW CORDED POLY/COTTON OUTER, NONWOVEN LINER, PVC DOTTED PALM, MATCHING KNIT WRIST	L	FLUORESCENT YELLOW	12 PR	120 PR
UCHF183	PREMIUM GRADE, CORDED POLY/COTTON OUTER, NONWOVEN LINER, NATURAL KNIT WRIST	L	NATURAL	12 PR	144 PR
UCHF18WDSC	PREMIUM GRADE, CORDED POLY/COTTON OUTER, NONWOVEN LINER, SAFETY CUFF	L-XL	NATURAL	12 PR	72 PR
UDCW3PK	HEAVY WEIGHT, CORDED POLY/COTTON AND WOOL LINER IN PALM AND FINGERS, 100% COTTON NATURAL KNIT WRIST	L	NATURAL	12 PR	72 PR
IPC194	STANDARD GRADE, POLY/COTTON OUTER, NONWOVEN LINER, NAVY KNIT WRIST	L	NATURAL	12 PR	144 PR
UPC194	PREMIUM-GRADE, POLY/COTTON OUTER, NONWOVEN LINER, NAVY KNIT WRIST	L	NATURAL	12 PR	144 PR
IPC195	DOUBLE PALM GLOVE, STANDARD GRADE, POLY/COTTON OUTER, NONWOVEN LINER, RED KNIT WRIST	L	NATURAL	12 PR	144 PR
UPC195	SUPER OIL RIG®, PREMIUM-GRADE, DOUBLE PALM, POLY/COTTON OUTER, NONWOVEN LINER, RED KNIT WRIST PRINTED BOTH HANDS WITH SUPER OIL RIG LOGO	L	NATURAL	12 PR	144 PR



UCHF18WDG



UCHF183



UPC195



LS0001



LS0002



ISG26BTPK

Hot Mill Gloves

Hot Mill styles are constructed using two or three layers of cotton and/or non-woven material in the palm. These gloves are designed for low to high temperature applications. This same palm construction can be used in the back of the hand where radiant heat is an issue. Hot Mills are available with knuckle straps and pull tab attachments and with a knit wrist, band top or gauntlet cuff.

Ideal for the petrochemical, gas and oil industries, forging, hot metal handling, glass handling, motor vehicle handling, logging, forestry, agriculture and other applications that require heat protection.

Loggers Special - The most popular design for the Pacific Northwest logger and woodsman

- Fourchette pattern for comfort
- 24-ounce canvas palm offers increased protection and durability
- Optional elastic band shirring behind the wrist for a secure a safe fit
- Available in a knit wrist, band top or rubberized gauntlet cuff in sizes M-XL

Item Number	Description	Sizes	Color	Pkg Qty	Case Qty
LS0001	LOGGERS SPECIAL, HEAVY WEIGHT, 100% COTTON DOUBLE PLY PALM, FOURCHETTE PATTERN, RED EXTERNAL ELASTIC, NAP OUT, RUBBERIZED GAUNTLET	M-XL	NATURAL	12 PR	72 PR
LS0002	LOGGERS SPECIAL, HEAVY WEIGHT, FOURCHETTE PATTERN, RED EXTERNAL ELASTIC, NAP OUT, 100% COTTON KNIT WRIST	M-XL	NATURAL	12 PR	72 PR
LS0004	LOGGERS SPECIAL, HEAVY WEIGHT, 100% COTTON DOUBLE PLY PALM, FOURCHETTE PATTERN, NAP OUT, 100% COTTON NATURAL KNIT WRIST	M-XL	NATURAL	12 PR	72 PR

Item Number	Description	Sizes	Color	Pkg Qty	Case Qty
U20BT	LIGHT WEIGHT, TRIPLE-PLY COTTON PALM, COTTON FINGERS, KNUCKLE STRAP, NAP OUT, BAND TOP CUFF	XL	NATURAL	12 PR	72 PR
U22G	LIGHT WEIGHT, DOUBLE-PLY, 100% COTTON, NAP IN, RUBBERIZED GAUNTLET CUFF	XL	NATURAL	12 PR	72 PR
U22KJGNO	LIGHT WEIGHT, DOUBLE-PLY, 100% COTTON, NAP OUT, RUBBERIZED GAUNTLET CUFF	L	NATURAL	12 PR	72 PR
UMG20TNEG	LIGHT WEIGHT, DOUBLE WOVEN GREEN PALM, NATURAL FINGERS WITH RED ELASTIC, DOUBLE WOVEN GREEN TURTLENECK, RUBBERIZED GAUNTLET	L	GREEN	12 PR	72 PR

Item Number	Description	Sizes	Color	Pkg Qty	Case Qty
I24BTP	MEDIUM WEIGHT, 100% COTTON, KNUCKLE STRAP, NAP OUT, BAND TOP CUFF	L	NATURAL	12 PR	120 PR
ISG26BTPK	MEDIUM WEIGHT, DOUBLE WOVEN OUTER, COTTON LINER, NAP OUT, BAND TOP	L	GREEN	12 PR	120 PR

(Continued on next page)



Hot Mill Gloves

Item Number	Description	Sizes	Color	Pkg Qty	Case Qty
U2433EPK	MEDIUM WEIGHT, TWO-PLY, NAP OUT, COTTON OUTER, NONWOVEN LINER, NAP OUT, 100% COTTON KNIT WRIST WITH RED ELASTIC	L	NATURAL	12 PR	72 PR
U2433P	MEDIUM WEIGHT, TWO-PLY, NAP OUT, COTTON OUTER, NONWOVEN LINER, KNUCKLE STRAP, 100% COTTON KNIT WRIST	L	NATURAL	12 PR	72 PR
U243BTPK	MEDIUM WEIGHT, DOUBLE-PLY PALM, COTTON OUTER, NON-WOVEN LINER, NAP OUT, BAND TOP CUFF	L	NATURAL	12 PR	72 PR
U243BTPKNI	MEDIUM WEIGHT, DOUBLE-PLY PALM, COTTON OUTER, NON-WOVEN LINER, NAP IN, BAND TOP CUFF	L	NATURAL	12 PR	72 PR
U243BTPNI	MEDIUM WEIGHT, TWO-PLY PALM, COTTON OUTER, NONWOVEN LINER, KNUCKLE STRAP, NAP IN, BAND TOP CUFF	S, L	NATURAL	12 PR	72 PR
U243BTP	MEDIUM WEIGHT, TWO-PLY, NAP OUT, COTTON OUTER, NONWOVEN LINER, KNUCKLE STRAP, NAP OUT, BAND TOP CUFF	S, L	NATURAL	12 PR	72 PR
U243GPNi	MEDIUM WEIGHT, TWO-PLY, NAP IN, COTTON OUTER, NONWOVEN LINER, KNUCKLE STRAP, NAP OUT, RUBBERIZED GAUNTLET CUFF	S, L	NATURAL	12 PR	72 PR
U243SGPK	MEDIUM WEIGHT, TWO-PLY, NAP OUT, COTTON OUTER, NONWOVEN LINER, NAP OUT, STARCHED GAUNTLET CUFF	L	NATURAL	12 PR	72 PR
U24BTP	MEDIUM WEIGHT, 100% COTTON, TWO-PLY PALM, KNUCKLE STRAP, NAP OUT, BAND TOP CUFF	L	NATURAL	12 PR	72 PR
U24DGP	MEDIUM WEIGHT, 100% COTTON, TWO-PLY PALM, KNUCKLE STRAP, NAP OUT, DUCK GAUNTLET	L-XL	NATURAL	12 PR	72 PR
U24G	MEDIUM WEIGHT, 100% COTTON, TWO-PLY PALM, KNUCKLE STRAP, NAP OUT, RUBBERIZED GAUNTLET WITH PULL	L	NATURAL	12 PR	72 PR
UDI2433KGC	MEDIUM WEIGHT, TWO-PLY PALM AND FINGERS, COTTON OUTER, NONWOVEN LINER, KNUCKLE STRAP, NATURAL NAP OUT, KNIT WRIST AND RUBBERIZED GAUNTLET CUFF	L	NATURAL	12 PR	72 PR
UDI2433	MEDIUM WEIGHT, TWO-PLY PALM AND FINGERS, COTTON OUTER, NONWOVEN LINER, KNUCKLE STRAP, NAP OUT, NATURAL KNIT WRIST	L	NATURAL	12 PR	72 PR
UDI243BT5P	MEDIUM WEIGHT, TWO-PLY PALM AND FINGERS, COTTON OUTER, NONWOVEN LINER, KNUCKLE STRAP, NAP OUT, 5-INCH BAND TOP CUFF	L	NATURAL	12 PR	72 PR
UDI243DG6P	MEDIUM WEIGHT, DOUBLE BACK, COTTON OUTER, NONWOVEN LINER, KNUCKLE STRAP, NAP OUT, 6 INCH DUCK GAUNTLET	S, L	NATURAL	12 PR	72 PR
UD243KBTPK	MEDIUM WEIGHT, TWO-PLY PALM AND FINGERS, COTTON OUTER, NONWOVEN PARA-ARAMID LINER, NAP OUT, BAND TOP CUFF.	L	NATURAL	12 PR	72 PR
UD243KDGPK	MEDIUM WEIGHT, TWO-PLY PALM AND FINGERS, COTTON OUTER, NONWOVEN PARA-ARAMID LINER, NAP OUT, DUCK GAUNTLET	L	NATURAL	12 PR	72 PR
UD243KGPk	MEDIUM WEIGHT, TWO-PLY PALM AND FINGERS, COTTON OUTER, NONWOVEN PARA-ARAMID LINER, NAP OUT, RUBBERIZED GAUNTLET	S	NATURAL	12 PR	72 PR
USG243PK6	MEDIUM WEIGHT, GREEN DOUBLE-PLY PALM, NATURAL FINGERS, NAP OUT, 6-INCH NATURAL 100% COTTON KNIT WRIST	L	GREEN	12 PR	72 PR
USG24TDG	MEDIUM WEIGHT, GREEN DOUBLE WOVEN DOUBLE-PLY PALM, NATURAL DOUBLE-PLY FINGERS, NATURAL TURTLE NECK, NAP OUT, DUCK GAUNTLET, TARGET LOGO ON BACK OF HAND	L, XL	GREEN	12 PR	72 PR
USG24TNGK	MEDIUM WEIGHT, GREEN DOUBLE WOVEN DOUBLE-PLY PALM, NATURAL DOUBLE-PLY FINGERS, NATURAL TURTLE NECK, NAP OUT, RUBBERIZED GAUNTLET, TARGET LOGO ON BACK OF HAND	L	GREEN	12 PR	72 PR
UMG24GPGF	MEDIUM WEIGHT, DOUBLE-WOVEN GREEN DOUBLE-PLY PALM AND FINGERS, KNUCKLE STRAP, NAP OUT, RUBBERIZED GAUNTLET	L	GREEN	12 PR	72 PR
UPDD24KGPk	MEDIUM WEIGHT, DOUBLE-PLY BLACK PVC DOT AND NONWOVEN KEVLAR® PALM, DOUBLE-PLY FLAME-RETARDED OLIVE-DRAB AND KEVLAR® FINGERS, NAP OUT, RUBBERIZED GAUNTLET	L	NATURAL	12 PR	72 PR
USG24B5PK	MEDIUM WEIGHT, DOUBLE-WOVEN GREEN DOUBLE-PLY PALM, NATURAL FINGERS, KNUCKLE STRAP, NAP OUT, 5" BAND TOP CUFF	XL	GREEN	12 PR	72 PR
USG24BTP	MEDIUM WEIGHT, DOUBLE-WOVEN GREEN DOUBLE-PLY PALM, NATURAL FINGERS, KNUCKLE STRAP, B NAP OUT, AND TOP CUFF	L	GREEN	12 PR	72 PR
USG24DGP	HOT MILL GLOVE, MEDIUM WEIGHT, DOUBLE-WOVEN GREEN DOUBLE-PLY PALM, NATURAL FINGERS, KNUCKLE STRAP, NAP OUT, DUCK GAUNTLET	L	GREEN	12 PR	72 PR
USJ26BTP	MEDIUM WEIGHT, TRIPLE-PLY COTTON, BURLAP AND NONWOVEN PALM, COTTON FINGERS, NAP OUT, BAND TOP GAUNTLET CUFF	L	NATURAL	12 PR	72 PR
Item Number	Description	Sizes	Color	Pkg Qty	Case Qty
I30BTP	HEAVY WEIGHT, 100% COTTON, NAP OUT, KNUCKLE STRAP, BANDTOP CUFF	L	NATURAL	12 PR	120 PR
ICC30WBTPK	HEAVY WEIGHT, 100% COTTON, WING THUMB PATTERN, CORDED COTTON OUTER, NAP OUT, BAND TOP CUFF	L	NATURAL	12 PR	120 PR



U2433P



UDI243BT5P



U243BTPKNI



U24G



USG24DGP



ICC30WBTPK

(Continued on next page)

Hot Mill Gloves



PI28BTP



U30BT



UF3P



UGF3P



UHG3035PK



U3018TNDG

Item Number	Description	Sizes	Color	Pkg Qty	Case Qty
IFJ24BTP	HEAVY WEIGHT, DOUBLE-PLY, FLAME RETARDANT OLIVE DRAB, KNUCKLE STRAP, NAP OUT, FLAME RETARDANT OLIVE DRAB BAND TOP CUFF	L	OLIVE DRAB	12 PR	120 PR
I245P	HEAVY WEIGHT, TRIPLE-PLY PALM, KNUCKLE STRAP, NAP IN, RED KNIT WRIST	L	NATURAL	12 PR	144 PR
PI283P	HEAVY WEIGHT, TRIPLE PLY COTTON PALM, COTTON FINGERS, KNUCKLE STRAP, NAP OUT, COTTON KNIT WRIST	L	NATURAL	12 PR	120 PR
PI28BTP	HEAVY WEIGHT, TRIPLE-PLY COTTON PALM, COTTON FINGERS, KNUCKLE STRAP, NAP OUT, BAND TOP CUFF	L-XL	NATURAL	12 PR	72 PR
U303037P	HEAVY WEIGHT, 30 OZ PALM & FINGERS, NAP OUT, 3.5" KNIT WRIST, KNUCKLE STRAP	L	NATURAL	12 PR	72 PR
U30BT	HEAVY WEIGHT, 100% COTTON, TRIPLE-PLY PALM, KNUCKLE STRAP, NAP OUT, BAND TOP AND PULL	L	NATURAL	12 PR	72 PR
U30BTP	HEAVY WEIGHT, 100% COTTON, TRIPLE-PLY PALM, KNUCKLE STRAP, NAP OUT, BAND TOP	L-XL	NATURAL	12 PR	72 PR
U30DGP	HEAVY WEIGHT, TRIPLE-PLY, 100% COTTON OUTER, KNUCKLE STRAP, NAP OUT, DUCK GAUNTLET	S	NATURAL	12 PR	72 PR
U30G	HEAVY WEIGHT, TRIPLE-PLY, 100% COTTON OUTER, NAP OUT, KNUCKLE STRAP, RUBBERIZED GAUNTLET	L	NATURAL	12 PR	72 PR
U30GP	HEAVY WEIGHT, 100% COTTON, TRIPLE-PLY PALM KNUCKLE STRAP, NAP OUT, RUBBERIZED GAUNTLET CUFF	XL	NATURAL	12 PR	72 PR
UDF3018BTP	HEAVY WEIGHT, TRIPLE-PLY PALM, DOUBLE-PLY FINGERS, KNUCKLE STRAP, NAP OUT, BAND TOP CUFF	L	NATURAL	12 PR	72 PR
UF30KDG6PK	HEAVY WEIGHT, TRIPLE-PLY KEVLAR® JERSEY OUTER AND COTTON LINER PALM, KEVLAR® JERSEY FINGERS, NAP OUT, 6-INCH DUCK GAUNTLET CUFF	L	NATURAL	12 PR	72 PR
UF3PKNI	HEAVY WEIGHT, TRIPLE-PLY PALM, COTTON AND NONWOVEN LINERS, NAP IN, 100% COTTON KNIT WRIST	L	NATURAL	12 PR	72 PR
UF3P	HEAVY WEIGHT, TRIPLE-PLY PALM, COTTON AND NONWOVEN LINERS, NAP OUT, 100% COTTON NATURAL KNIT WRIST	L	NATURAL	12 PR	72 PR
UFBTPK	HEAVY WEIGHT, TRIPLE-PLY PALM, COTTON AND NONWOVEN LINERS, NAP OUT, BAND TOP CUFF	L	NATURAL	12 PR	72 PR
UFBTPKNI	HEAVY WEIGHT, TRIPLE-PLY PALM, COTTON AND NONWOVEN LINERS, NAP IN, BAND TOP CUFF	S, L	NATURAL	12 PR	72 PR
UFBTP	HEAVY WEIGHT, TRIPLE-PLY PALM, COTTON AND NONWOVEN LINERS, KNUCKLE STRAP, NAP OUT, BAND TOP CUFF	L	NATURAL	12 PR	72 PR
UFBTPRH	HEAVY WEIGHT, NAP OUT, COT OUTER, TWO NONWOVEN LINERS, NAP OUT, BAND TOP, KNUCKLE STRAP RIGHT HAND ONLY	L	NATURAL	12 PR	72 PR
UFR30KDGP	HEAVY WEIGHT, TRIPLE-PLY PALM, ARAMID OUTER WITH TWO COTTON LINERS, ARAMID JERSEY FINGERS, NAP OUT, DUCK GAUNTLET CUFF, STITCHED WITH KEVLAR® THREAD	L	NATURAL	12 PR	72 PR
UFDGP	HEAVY WEIGHT, TRIPLE-PLY PALM, COTTON AND NONWOVEN LINERS, KNUCKLE STRAP, NAP OUT, DUCK GAUNTLET	L	NATURAL	12 PR	72 PR
UFR30KBTPK	HEAVY WEIGHT, TRIPLE-PLY PALM, ARAMID OUTER WITH TWO COTTON LINERS, ARAMID JERSEY FINGERS, NAP OUT, BAND TOP CUFF, STITCHED WITH KEVLAR® THREAD	L	NATURAL	12 PR	72 PR
UGF3P	HEAVY WEIGHT, TRIPLE-PLY GREEN COTTON AND NONWOVEN LINER PALM, KNUCKLE STRAP, NAP OUT, 100% COTTON NATURAL KNIT WRIST	L	GREEN	12 PR	72 PR
UGFBTP	HEAVY WEIGHT, TRIPLE-PLY GREEN COTTON AND NONWOVEN LINER PALM, KNUCKLE STRAP, NAP OUT, BAND TOP CUFF	L	NATURAL	12 PR	72 PR
UGFDGP	HEAVY WEIGHT, TRIPLE-PLY PALM, GREEN COTTON AND NONWOVEN LINER PALM, KNUCKLE STRAP, NAP OUT, DUCK GAUNTLET CUFF	L	GREEN	12 PR	72 PR
UHDG3035PK	HEAVY WEIGHT, 100% COTTON TRIPLE-PLY PALM, DOUBLE-PLY GREEN COTTON AND NONWOVEN LINER FINGERS, NAP OUT, 5-INCH NATURAL COTTON KNIT WRIST	S, L, XL	NATURAL	12 PR	72 PR
UHDG30BTPK	HEAVY WEIGHT, 100% COTTON TRIPLE-PLY PALM, GREEN 100% COTTON DOUBLE-PLY FINGERS, NAP OUT, BAND TOP CUFF	L	NATURAL	12 PR	72 PR
UHDG30K5PK	HEAVY WEIGHT, 100% COTTON TRIPLE-PLY PALM, GREEN 100% COTTON DOUBLE-PLY FINGERS, NAP OUT, 5-INCH KEVLAR® KNIT WRIST	L	NATURAL	12 PR	72 PR

(Continued on next page)



Hot Mill Gloves

Item Number	Description	Sizes	Color	Pkg Qty	Case Qty
UHFBTP	HEAVY WEIGHT, COTTON AND NONWOVEN TRIPLE-PLY PALM, KNUCKLE STRAP, NAP OUT, BAND TOP CUFF	L	NATURAL	12 PR	144 PR
UJK30BTPK	HEAVY WEIGHT, TRIPLE-PLY PALM, KEVLAR® JERSEY OUTER AND COTTON LINERS, KEVLAR® JERSEY FINGERS, NAP OUT, FLAME RETARDED OLIVE DRAB BAND TOP CUFF. KEVLAR® STITCHED	L	YELLOW	12 PR	72 PR
UJK30DGPK	HEAVY WEIGHT, TRIPLE-PLY PALM, KEVLAR® JERSEY OUTER AND COTTON LINERS, KEVLAR® JERSEY FINGERS, NAP OUT, DUCK GAUNTLET. KEVLAR® STITCHED	L	YELLOW	12 PR	72 PR
UKWG8	HEAVY LONG GAUNTLET ARAMID OUTER, 2 PLY WOOL LINER ALL OVER, NAP OUT	L	YELLOW	12 PR	36 PR
Item Number	Description	Sizes	Color	Pkg Qty	Case Qty
U28KODFBTK	EXTRA HEAVY WEIGHT, TRIPLE-PLY PALM, COTTON OUTER, KEVLAR® AND COTTON LINERS, OLIVE DRAB FLAME RETARDED FINGERS AND KNUCKLE STRAP, NAP OUT, BAND TOP CUFF	L	NATURAL	12 PR	48 PR
U3018TNDG	EXTRA HEAVY WEIGHT, TRIPLE-PLY PALM AND FINGERS, COTTON OUTER, COTTON AND RAYON LINERS, GREEN KNUCKLE STRAP, NATURAL DOUBLE-WOVEN TURTLENECK, NAP OUT, DUCK GAUNTLET	S, L, XL	NATURAL	12 PR	72 PR
UDFR32KBPK	EXTRA HEAVY WEIGHT, TRIPLE-PLY PALM WITH ARAMID OUTER AND 100% COTTON LINERS, DOUBLE-PLY FINGERS WITH ARAMID OUTER AND 100% COTTON LINER, NAP OUT, OLIVE-DRAB FLAME RETARDED BAND TOP CUFF, KEVLAR® STITCHED	L	NATURAL	12 PR	72 PR
UDFR32KDPK	EXTRA HEAVY WEIGHT, TRIPLE-PLY PALM WITH ARAMID OUTER AND 100% COTTON LINERS, DOUBLE-PLY FINGERS WITH ARAMID OUTER AND 100% COTTON LINER, NAP OUT, DUCK GAUNTLET CUFF, KEVLAR® STITCHED	L	NATURAL	12 PR	72 PR



UJK30BTPK



UDFR32KDPK



IF34TNDGP

Flame Retardant Gloves

When you're looking for consistent, high-quality flame-retardant work gloves, Southern Glove beats the competition hands down!

- Independently certified fire resistance
- Heavyweight 22-ounce construction that surpasses standard 18-ounce double palms
- Blowout Shield logo and tagged with flame-retardant label
- Excellent abrasion resistance
- High visibility
- Wing-thumb pattern offers comfortable freedom of movement with no seams in the wear area
- Complements and completes the protection flame-retardant clothing
- Customize with your logo on the back of left glove

Ideal for the petrochemical, gas and oil industries, forging, hot metal handling, glass handling, motor vehicle handling and other applications that require heat protection.

Item Number	Description	Sizes	Color	Pkg Qty	Case Qty
IF34TNDGP	EXTRA HEAVY WEIGHT, TRIPLE-PLY, FLAME RETARDANT, KNUCKLE STRAP, NAP OUT, TURTLENECK, DUCK GAUNTLET CUFF	L	OLIVE DRAB	12 PR	120 PR
IFCCFG209	BLOWOUT SHIELD, HEAVYWEIGHT, 100% COTTON CORD, BLACK FLAME RETARDANT KNIT WRIST	L	FLUORESCENT GREEN	12 PR	144 PR
IFCCF0209	BLOWOUT SHIELD, HEAVYWEIGHT, 100% COTTON CORD, BLACK FLAME RETARDANT KNIT WRIST	L	FLUORESCENT ORANGE	12 PR	144 PR
IFCCWT209	BLOWOUT SHIELD, HEAVYWEIGHT, 100% COTTON CORD, BLACK FLAME RETARDANT KNIT WRIST	L	NATURAL	12 PR	144 PR
IFCCF0269	BLOWOUT SHIELD, EXTRA HEAVYWEIGHT, CORDED PALM, BLACK FLAME RETARDANT KNIT WRIST, WING THUMB	L	FLUORESCENT ORANGE	12 PR	144 PR
IWFG269	BLOWOUT SHIELD, EXTRA HEAVYWEIGHT, 100% COTTON, BLACK FLAME RETARDANT KNIT WRIST, WING THUMB	L	FLUORESCENT GREEN	12 PR	144 PR
UF243BTPL	MEDIUM WEIGHT OLIVE DRAB, FLAME RETARDANT COT OUTER, NONWOVEN LINER, NAP OUT, BAND TOP, KNUCKLE STRAP	L	OLIVE DRAB	12 PR	72 PR
IF34BTP	EXTRA HEAVY WEIGHT, TRIPLE-PLY, FLAME RETARDANT, KNUCKLE STRAP, NAP OUT, BAND TOP CUFF	L	OLIVE DRAB	12 PR	120 PR



UF243DG



IFCCFG209



IFCCF0209

Impact Gloves

Our exclusive line of Sarco Impact Gloves help provide protection to the wearer's fingers and hand from crushing blows in oil drilling and heavy manufacturing environments. The Arma Tuff Glove helps to provide medium impact protection and high dexterity. It offers midrange resistance with added comfort and dexterity. Hipora®, a waterproof barrier, and Thinsulate® material are available as liners on the Arma Tuff gloves for winter wear. The Sarco Impact Glove offers unparalleled protection due to its dual layer EVA impact resistant foam rubber. Both gloves offer a variety of palm options for special applications, including leather and cloth options.

The Sarco Impact Glove comes in a variety of palm features including:

- PVC dotted
- Polycotton corded double palm
- Double/woven green
- Kevlar® and Twaron®
- Split and grain leather
- Flame-retardant cotton



ACHMECGO



ACHMECNO



CHMECHG



FKHMECHO



GLMECHO



GMECHO

Arma-Tuff Glove features:

- Thinsulate® and Hipora® liners for winter wear
- Cut level 5 Kevlar®/glass liner for cut and slash protection
- The Arma Tuff Armadillo offers one-piece TPR rubber protection that covers the back of the hand, fingers and thumb

Arma-Tuff Palm features:

- Polycotton corded double palm
- Orange silicon dot single palm
- Goatskin leather palm
- Split leather palm
- Synthetic leather with textured PVC palm
- Double woven green palm

Armadillo Glove features:

- One-piece TPR rubber protection that covers the back of the hand, fingers and thumb
- High-visibility, corded double palms and contrasting-colored TPR back
- Kevlar® reinforced thumb crotch
- Three inch neoprene cuff
- Amazing dexterity and comfort

Rig Rider Glove features:

- Corded polyester & cotton blend palm and fourchettes for excellent durability and proven wet and dry grip
- Wing thumb pattern provides long-wearing comfort
- Reinforced thumb crotch for extended wear
- Hi-visibility 4-way stretch back
- Hi-visibility TPR impact resistance on back of hand, fingers and thumb

Can be used in a myriad of harsh environments where hand protection is crucial. Ideal for the oilfield, construction and rigging industries.

Item Number	Description	Sizes	Color	Pkg Qty	Case Qty
ACHMECGO	FLUORESCENT GREEN CORDED POLY/COTTON DOUBLE-PLY PALM, ONE-PIECE, HIGH VISIBILITY ORANGE TPR IMPACT PROTECTION, REINFORCED TEXTURED PVC THUMB CROTCH, NEOPRENE CUFF	M, 2XL	GREEN	12 PR	144 PR
ACHMECNO	NATURAL CORDED POLY/COTTON DOUBLE-PLY PALM, ONE-PIECE, HIGH VISIBILITY ORANGE TPR IMPACT PROTECTION, REINFORCED TEXTURED PVC THUMB CROTCH, NEOPRENE CUFF	M, 2XL	BLACK	12 PR	144 PR
APDMECOG	ORANGE SILICON DOTTED COTTON PALM, ONE-PIECE, HIGH VISIBILITY GREEN TPR IMPACT PROTECTION, REINFORCED TEXTURED PVC THUMB CROTCH, NEOPRENE CUFF	L-2XL	FLUORESCENT GREEN	12 PR	144 PR
ATPRMECOO	ARMADILLO IMPACT GLOVE, SYNTHETIC LEATHER PALM WITH TEXTURED PVC PATCHES, ONE-PIECE, HIGH VISIBILITY ORANGE TPR IMPACT PROTECTION, REINFORCED TEXTURED PVC THUMB CROTCH, NEOPRENE CUFF	M, 2XL	ORANGE	12 PR	144 PR
CHMECHG	ARMA-TUFF IMPACT GLOVE, NATURAL POLY/COTTON CORDED DOUBLE-PLY PALM, ACCORDION-STYLE EXTRA FIRM EVA FOAM PADDED FLUORESCENT GREEN BACK, REFLECTIVE KNUCKLE STRAP, TPR IMPACT PROTECTION ON FINGERS AND THUMB, REINFORCED TEXTURED PVC THUMB CROTCH, NEOPRENE CUFF	S, M, XL	FLUORESCENT GREEN	12 PR	144 PR
CHMECHO	ARMA-TUFF IMPACT GLOVE, NATURAL POLY/COTTON CORDED DOUBLE-PLY PALM, ACCORDION-STYLE EXTRA FIRM EVA FOAM PADDED FLUORESCENT ORANGE BACK, REFLECTIVE KNUCKLE STRAP, TPR IMPACT PROTECTION ON FINGERS AND THUMB, REINFORCED TEXTURED PVC THUMB CROTCH, NEOPRENE CUFF	S-2XL	FLUORESCENT ORANGE	12 PR	144 PR
FKHMECHO	ARMA-TUFF IMPACT GLOVE, NATURAL POLY/COTTON CORDED DOUBLE-PLY PALM, CUT RESISTANT KEVLAR® LINER, ACCORDION-STYLE EXTRA FIRM EVA FOAM PADDED FLUORESCENT ORANGE BACK, REFLECTIVE KNUCKLE STRAP, TPR IMPACT PROTECTION ON FINGERS AND THUMB, REINFORCED TEXTURED PVC THUMB CROTCH, NEOPRENE CUFF WITH VELCRO CLOSURE AND LOOP TO HANG GLOVES	L-XL	FLUORESCENT ORANGE	12 PR	144 PR
GLMECHO	ARMA-TUFF IMPACT GLOVE, GRAIN GOATSKIN LEATHER PALM, ACCORDION-STYLE EXTRA FIRM EVA FOAM PADDED FLUORESCENT GREEN BACK, REFLECTIVE KNUCKLE STRAP, TPR IMPACT PROTECTION ON FINGERS AND THUMB, REINFORCED TEXTURED PVC THUMB CROTCH, NEOPRENE CUFF	L-2XL	ORANGE	12 PR	144 PR
GMECH30	ARMA-TUFF IMPACT GLOVE, GREEN DOUBLE-WOVEN PALM, ACCORDION-STYLE EXTRA FIRM EVA FOAM PADDED FLUORESCENT ORANGE BACK, REFLECTIVE KNUCKLE STRAP, TPR IMPACT PROTECTION ON FINGERS AND THUMB, REINFORCED TEXTURED PVC THUMB CROTCH, 3" NEOPRENE CUFF	L-2XL	ORANGE	12 PR	144 PR
GMECHO	GREEN DOUBLE-WOVEN COTTON PALM, ACCORDION STYLE EXTRA FIRM EVA FOAM PADDED FLUORESCENT ORANGE BACK, TPR IMPACT PROTECTION, REINFORCED TEXTURED PVC THUMB CROTCH, 3" NEOPRENE CUFF	S-2XL	ORANGE	12 PR	144 PR

(Continued on next page)



Impact Gloves

Item Number	Description	Sizes	Color	Pkg Qty	Case Qty
GTPMECHO	ARMATUFF IMPACT GLOVE, DOUBLE WOVEN GREEN PALM WITH TEXTURED PALM PATCHES, THINSULATE® AND HIPORA® WATERPROOF BREATHABLE LINERS, ACCORDION STYLE EXTRA FIRM EVA FOAM PADDED BACK, TPR STRIPS ON BACK OF FINGERS AND THUMB, ORANGE SPANDEX BACK, REFLECTIVE KNUCKLE STRAP, NEOPRENE CUFF WITH VELCRO CLOSURE, LOOP TO HANG GLOVES	XL	GREEN	12 PR	144 PR
GTPTH30	ARMATUFF IMPACT GLOVE, DOUBLE WOVEN GREEN PALM WITH TEXTURED PALM PATCHES, THINSULATE® AND HIPORA® WATERPROOF BREATHABLE LINERS, ACCORDION STYLE EXTRA FIRM EVA FOAM PADDED BACK, TPR STRIPS ON BACK OF FINGERS AND THUMB, ORANGE SPANDEX BACK, REFLECTIVE KNUCKLE STRAP, 3" NEOPRENE CUFF WITH VELCRO CLOSURE, LOOP TO HANG GLOVES	L, XL	GREEN	12 PR	144 PR
ICHF18FGIP	DOUBLE PALM GLOVE, STANDARD GRADE, FLUORESCENT GREEN CORDED POLYCOTTON OUTER, NONWOVEN LINER, MATCHING KNIT WRIST, ANSI 138 LEVEL 1 IMPACT PROTECTION ON FINGERS, THUMB AND BACK OF HAND	L	NATURAL	12 PR	144 PR
KPGLMEO	ARMA-TUFF IMPACT GLOVE, GRAIN GOATSKIN LEATHER PALM WITH CE CUT LEVEL 5 KEVLAR®/GLASS LINER, ACCORDION-STYLE EXTRA FIRM EVA FOAM PADDED FLUORESCENT ORANGE BACK, TPR IMPACT PROTECTION ON FINGERS AND THUMB, REINFORCED TEXTURED PVC THUMB CROTCH, NEOPRENE CUFF	L-2XL	ORANGE	12 PR	144 PR
KPPDMECHO	ARMA-TUFF IMPACT GLOVE, SUPER-STICKY ORANGE SILICONE DOT PALM WITH CE CUT LEVEL 5 KEVLAR®/GLASS LINER, ACCORDION-STYLE EXTRA FIRM EVA FOAM PADDED FLUORESCENT ORANGE BACK, TPR IMPACT PROTECTION ON FINGERS AND THUMB, REINFORCED TEXTURED PVC THUMB CROTCH, NEOPRENE CUFF	L-2XL	ORANGE	12 PR	144 PR
KPSLDPMEO	ARMA-TUFF IMPACT GLOVE, SPLIT LEATHER DOUBLE PALM, KEVLAR® LINER, LEATHER PALM PATCHES, ACCORDION-STYLE EXTRA FIRM EVA FOAM PADDED FLUORESCENT ORANGE BACK, REFLECTIVE KNUCKLE STRAP, TPR IMPACT PROTECTION ON FINGERS AND THUMB, REINFORCED TEXTURED PVC THUMB CROTCH, NEOPRENE CUFF	L-XL	ORANGE	12 PR	72 PR
MECHO	MECHANIC STYLE ORANGE IMPACT GLOVE WITH SOUTHERN GLOVE BRANDING	M-3XL	ORANGE	12 PR	144 PR
ODTEC30	ARMA-TUFF IMPACT GLOVE, SYNTHETIC LEATHER PALM WITH SILICONE SLASHES, ACCORDION-STYLE EXTRA FIRM EVA FOAM PADDED FLUORESCENT ORANGE BACK, TPR IMPACT PROTECTION ON FINGERS AND THUMB, REINFORCED TEXTURED PVC THUMB CROTCH, NEOPRENE CUFF	L-2XL	ORANGE	12 PR	144 PR
PDMECHG	ARMA-TUFF IMPACT GLOVE, SUPER-STICKY ORANGE SILICONE DOT PALM, ACCORDION-STYLE EXTRA FIRM EVA FOAM PADDED FLUORESCENT GREEN BACK, TPR IMPACT PROTECTION ON FINGERS AND THUMB, REINFORCED TEXTURED PVC THUMB CROTCH, NEOPRENE CUFF	L-2XL	GREEN	12 PR	144 PR
PDMECHO	ARMA-TUFF IMPACT GLOVE, SUPER-STICKY SILICONE DOT PALM, ACCORDION STYLE EXTRA FIRM EVA FOAM PADDED FLUORESCENT ORANGE BACK, TPR IMPACT PROTECTION, REINFORCED TEXTURED PVC THUMB CROTCH, NEOPRENE CUFF	S-XL	ORANGE	12 PR	144 PR
PDTHMECHO	ARMA-TUFF IMPACT GLOVE, SUPER-STICKY ORANGE SILICONE DOT PALM, ACCORDION-STYLE EXTRA FIRM EVA FOAM PADDED FLUORESCENT ORANGE BACK, TPR IMPACT PROTECTION ON FINGERS AND THUMB, REINFORCED TEXTURED PVC THUMB CROTCH, NEOPRENE CUFF	L-XL	ORANGE	12 PR	144 PR
RCWMECGO	RIG RIDER IMPACT GLOVE, CORDED DOUBLE-PLY POLYESTER/COTTON PALM FOR SUPERIOR GRIP IN WET AND OILY CONDITIONS 4-WAY STRETCH FLUORESCENT GREEN BACK WITH ORANGE TPR ANSI 138 LEVEL 1 IMPACT PROTECTION, REINFORCED TEXTURED PVC GRIP MATERIAL IN THUMB CROTCH, NEOPRENE CUFF	M-3XL	NATURAL	12 PR	144 PR
RGMECH	ARMA-TUFF ROOFER'S GLOVE, SYNTHETIC LEATHER PALM, 3/4 INDEX FINGER, PALM PATCHES, VELCRO CLOSURE	M-L	BLACK	12 PR	72 PR
RPDMECGO	RIG RIDER IMPACT GLOVE, DURABLE SYNTHETIC LEATHER PALM WITH TEXTURED PVC PATCHES FOR UNRIVALED ABRASION RESISTANCE, 4-WAY STRETCH FLUORESCENT GREEN BACK WITH ORANGE TPR ANSI 138 LEVEL 1 IMPACT PROTECTION, REINFORCED REINFORCED TEXTURED PVC GRIP MATERIAL IN THUMB CROTCH, NEOPRENE CUFF	M-2XL	NATURAL	12 PR	144 PR
RTPMECGO	RIG RIDER IMPACT GLOVE, TOUGH-WEARING SYNTHETIC LEATHER PALM PROVIDES ABRASION RESISTANCE AND SUPERIOR GRIP, 4-WAY STRETCH FLUORESCENT GREEN BACK WITH ORANGE TPR ANSI 138 LEVEL 1 IMPACT PROTECTION, REINFORCED TEXTURED PVC GRIP MATERIAL IN THUMB CROTCH, NEOPRENE CUFF	M-2XL	BLACK	12 PR	144 PR
SD0005R	CORDED POLY/COTTON DOUBLE-PLY PALM, THUMB PROTECTOR AND FINGER PROTECTOR, FLUORESCENT ORANGE LYCRA 4-WAY STRETCH BACK, POLYESTER KNIT WRIST, DERRICKMAN LEVEL IMPACT PROTECTION	M	RED	12 PR	144 PR
SD0005RSC	CORDED POLY/COTTON DOUBLE-PLY PALM, THUMB PROTECTOR AND FINGER PROTECTOR, FLUORESCENT ORANGE LYCRA 4-WAY STRETCH BACK, SAFETY CUFF DERRICKMAN LEVEL IMPACT PROTECTION	M	RED	12 PR	144 PR



GTPMECHO



ICHF18FGIP



RCWMECGO



RPDMECGO



RTPMECGO



SD0005R

(Continued on next page)

Impact Gloves

Item Number	Description	Sizes	Color	Pkg Qty	Case Qty
SD0006R	ORANGE DOT PALM, THUMB PROTECTOR AND FINGER PROTECTOR, FLUORESCENT ORANGE LYCRA 4-WAY STRETCH BACK, POLYESTER KNIT WRIST, DERRICKMAN LEVEL IMPACT PROTECTION	XL	RED	12 PR	144 PR
SIG0060	ORANGE DOT PALM, THUMB PROTECTOR AND FINGER PROTECTOR, FLUORESCENT ORANGE LYCRA 4-WAY STRETCH BACK, POLYESTER KNIT WRIST, ANSI 138 LEVEL 3 IMPACT PROTECTION	M	ORANGE	12 PR	144 PR
SLDPMECHO	ARMA-TUFF IMPACT GLOVE, EXTRA-DURABLE SPLIT COW LEATHER PALM, ACCORDION-STYLE EXTRA FIRM EVA FOAM PADDED FLUORESCENT ORANGE BACK, TPR IMPACT PROTECTION ON FINGERS AND THUMB, REINFORCED TEXTURED PVC THUMB CROTCH, NEOPRENE CUFF	M-XL	ORANGE	12 PR	144 PR
TPHMECHO	ARMA-TUFF IMPACT GLOVE, SYNTHETIC LEATHER PALM WITH TEXTURED PVC PATCHES, HIPORA® WATERPROOF BREATHABLE LINER ACCORDION-STYLE EXTRA FIRM EVA FOAM PADDED FLUORESCENT ORANGE BACK, TPR IMPACT PROTECTION ON FINGERS AND THUMB, REINFORCED TEXTURED PVC THUMB CROTCH, NEOPRENE CUFF	L-XL	ORANGE	12 PR	144 PR
TPMECHG	ARMA-TUFF IMPACT GLOVE, SYNTHETIC LEATHER PALM WITH TEXTURED PVC PATCHES, ACCORDION-STYLE EXTRA FIRM EVA FOAM PADDED FLUORESCENT GREEN BACK, TPR IMPACT PROTECTION ON FINGERS AND THUMB, REINFORCED TEXTURED PVC THUMB CROTCH, NEOPRENE CUFF	M, XL	GREEN	12 PR	144 PR
TPTHMECHO	ARMA-TUFF IMPACT GLOVE, SYNTHETIC LEATHER PALM WITH TEXTURED PVC PATCHES, THINSULATE® LINER, ACCORDION-STYLE EXTRA FIRM EVA FOAM PADDED FLUORESCENT ORANGE BACK, TPR IMPACT PROTECTION ON FINGERS AND THUMB, REINFORCED TEXTURED PVC THUMB CROTCH, NEOPRENE CUFF	L-2XL	ORANGE	12 PR	144 PR



SD0006R



TPHMECHO



ISHM901



SKMC901



ISM3301



GCLLPD

Machine Knit Gloves

The most economical gloves used in manufacturing environments, Machine Knits are made of 100% cotton, poly cotton, acrylic, nylon or a combination of various yarns. Designed to be used alone or as a liner, Machine Knits help keep hands protected in light industrial applications. Various coatings can also be applied to offer abrasion resistance and grip.

General maintenance, material handling, assembly, shipping and receiving, agriculture and assembly.

Item Number	Description	Sizes	Color	Pkg Qty	Case Qty
900RED	RED COATED KNIT LINER KNIT WRIST	L	RED	12 PR	72 PR
ISBPC28	7 GAUGE, MEDIUM WEIGHT, 18%/15% BLEND POLYESTER/BLEACHED COTTON	XS-XL	NATURAL	12 PR	300 PR
ISHM901	7 GAUGE, MEDIUM WEIGHT, GRAY COTTON/POLYESTER	S-XL	GRAY	12 PR	300 PR
ISM3301	7 GAUGE, MEDIUM WEIGHT, COTTON/POLYESTER	S-XL	NATURAL	12 PR	300 PR
ISM3311	7 GAUGE, MEDIUM WEIGHT, COTTON/POLYESTER, BLACK PVC DOTS ONE SIDE	L	NATURAL	12 PR	300 PR
ISM3321	7 GAUGE, MEDIUM WEIGHT, COTTON/POLYESTER, BLACK PVC DOTS TWO SIDE	S, L	NATURAL	12 PR	300 PR
ISM3C01	7 GAUGE, MEDIUM WEIGHT, 100% COTTON	S-XL	NATURAL	12 PR	300 PR
ISM7K21	7 GAUGE, MEDIUM WEIGHT, 100% KEVLAR, BLACK PVC DOTS TWO SIDES	M, XL	NATURAL	12 PR	144 PR
ISOHC2	7 GAUGE, ORANGE ACRYLIC STRING, HONEYCOMB COATING 2 SIDES	S-XL	ORANGE	12 PR	144 PR
ISH3301	7 GAUGE, HEAVY WEIGHT, COTTON/POLY KNIT	S-L	NATURAL	12 PR	300 PR
ISH3C01	7 GAUGE, HEAVY WEIGHT, 100% COTTON	S-XL	NATURAL	12 PR	300 PR
ISHH901	7 GAUGE, HEAVY WEIGHT, GRAY, COTTON/POLYESTER	S-XL	GRAY	12 PR	300 PR
SKMC901	7 GAUGE, HEAVY WEIGHT, COTTON/POLYESTER	S-L	MULTI COLOR	12 PR	288 PR

Palm Dip Gloves

Palm Dips offer an extra layer of protection to String Knit style gloves. Foam nitrile, polyurethane and natural latex rubber are available. They offer excellent dexterity and grip, as well as abrasion and puncture resistance.

Light duty general purpose gloves, ideal for assembly, automotive, carpentry, concrete, electrical, construction, warehousing, inspection, general handling, physical tasks & disposal operations.

Item Number	Description	Sizes	Color	Pkg Qty	Case Qty
BNBPUPD	13 GAUGE NYLON SHELL, BLACK ULTRA-THIN POLYURETHANE PALM AND FINGER TIP DIP	M, XL	BLACK	12 PR	144 PR
GCLLPD	10 GAUGE, MACHINE KNIT GRAY POLY/COTTON, BLACK LATEX PALM DIP	S-XL	GRAY	12 PR	144 PR

(Continued on next page)



Palm Dip Gloves

Item Number	Description	Sizes	Color	Pkg Qty	Case Qty
GCBLPD	MACHINE KNIT, 10 GAUGE, GRAY POLY/COTTON, BLUE LATEX PALM DIP	S-XL	BLUE/GRAY	12 PR	144 PR
GCGLPD	MACHINE KNIT, 10 GAUGE, GRAY POLY/COTTON, BLUE LATEX PALM DIP	S, XL	GRAY	12 PR	144 PR
GNBFNPD	MACHINE KNIT, 10 GAUGE, GRAY NYLON, BLACK FOAM NITRILE PALM DIP	S-XL	GRAY	12 PR	144 PR
GNBNPD	MACHINE KNIT, 13 GAUGE, GRAY NYLON, BLACK NITRILE PALM DIP	S-XL	GRAY	12 PR	144 PR
OFBLLPD	ARCTIC GRIPPER, FLUORESCENT ORANGE ACRYLIC SHELL, BLACK CRINKLE FINISH LATEX DIPPED PALM	S-XL	BLACK	12 PR	120 PR
GFBLPD	ARCTIC GRIPPER, FLUORESCENT GREEN ACRYLIC SHELL, BLACK CRINKLE FINISH LATEX DIPPED PALM	S-XL	FLUORESCENT GREEN	12 PR	120 PR
WCBLPC	MACHINE KNIT, 7 GAUGE POLY/COTTON SHELL, BLUE LATEX BRUSH-ON PALM COAT	M-XL	WHITE	12 PR	144 PR
WNGFNPD	MACHINE KNIT, 10 GAUGE NYLON SHELL, GRAY FOAM NITRILE PALM DIP	M	GRAY	12 PR	144 PR
WNWPUPD	MACHINE KNIT, 13 GAUGE WHITE NYLON SHELL, WHITE POLYURETHANE PALM DIP	L	GRAY	12 PR	144 PR



OFBLLPD



WCBLPC

Cut Resistant Knit Gloves

Para-aramid is a composite yarn developed by DuPont and its attributes include high strength and outstanding slash and heat resistance. Styles using this yarn can also be coated for extra abrasion and grip.

Ideal for manufacturing areas where sharp or jagged metal objects, glass or abrasives are handled. Excellent cut, abrasion and heat resistant properties. Light duty general purpose gloves, assembly, automotive, carpentry, concrete, electrical, construction, warehousing, inspection, general handling, physical tasks & disposal operations, industrial work in sheet metal, metal stampings, glass handling, manufacturing & welding.

Item Number	Description	Sizes	Color	Pkg Qty	Case Qty
KUTTEK	13 GA SALT & PEPPER DYNEEMA KNIT, POLYURETHANE PALM DIP, ANSI A3 CUT LEVEL	S, 2XL	GRAY	12 PR	120 PR
PPE5SBNPD	CUT-RESISTANT 10 GAUGE, CE CUT LEVEL 5 HPPE SALT AND PEPPER KNIT SHELL, SANDY FINISH BLACK NITRILE PALM DIP	L-XL	GRAY	12 PR	144 PR



KUTTEK

Coated Gloves

Designed for chemical and puncture resistance, Coated Gloves come in supported or unsupported styles. Southern Glove offers Coated Gloves in the following materials. Neoprene coated gloves offer excellent flexibility, grip and chemical protection. Latex - A natural rubber product ideal for protecting against contaminants and chemicals. Latex is also economical. Since Latex stretches, it is comfortable to wear. Nitrile - Manufactured from synthetic latex, Nitrile gloves are 3X more puncture and abrasion resistant than Latex. Nitrile gloves offer protection from a variety of chemicals and have a low coefficient of friction, making them easier to don. PVC gloves offer chemical resistance to a variety of acids and oils and are available in various finishes and lengths.

Ideal for industrial work, chemical resistance, materials handling, fishing, food processing.

Item Number	Description	Sizes	Color	Pkg Qty	Case Qty
I88510	IMPORT BLACK PVC, SMOOTH FINISH, INTERLOCK LINED, 10"	L	BLACK	12 PR	120 PR
I88514	IMPORT BLACK PVC, SMOOTH FINISH, INTERLOCK LINED, 14"	L	BLACK	12 PR	120 PR
IBNEYL	NEOPRENE OVER YELLOW LATEX, FLOCK LINED, 28 MIL., 13"	L	BLUE	12 PR	144 PR
IBNPB	COATED GLOVE, CUT AND SEWN, INTERLOCK LINED, BLUE NITRILE FULL COAT, PERFORATED BACK, SLIP-ON PATTERN	M-L	BLUE	1	72
IGNFL15	15 MIL-13 -GREEN NITRILE FLOCK LINED	M-XL	GREEN	12 PR	120 PR
INFCS	PVC GLOVE FULLY COATED BLUE NITRILE, JERSEY SHELL, SAFETY CUFF	L-XL	BLUE	12 PR	120 PR
INRQVGR	FULLY COATED ROUGH FINISH NATURAL TAN RUBBER, KEVLAR®/COTTON LINER, GAUNTLET CUFF	ONE SIZE	BLUE	12 PR	144 PR
IRNFCS	FULLY COATED BLUE NITRILE, JERSEY LINED, ROUGH FINISH, SAFETY CUFF	L-XL	BLUE	12 PR	144 PR
OPVCFCS	PVC GLOVE, FULLY COATED, FOAM LINED, 2.5 INCH RUBBERIZED SAFETY CUFF	L	FLUORESCENT ORANGE	12 PR	120 PR



I88510



IBNEYL



INFCS

Terry Cloth Gloves & Pads

Loop out Terry outers offer protection in material handling for extreme temperature environments. These cost-effective gloves come in a variety of cuff options including knit wrist, band top or gauntlet. This category is offered in knitted and cut and sewn patterns.

General industrial work, refrigerated areas, general maintenance, material handling, construction, agricultural, gardening, outdoor uses.

Item Number	Description	Sizes	Color	Pkg Qty	Case Qty
GTK14LI	MACHINE KNIT, PREMIUM GRADE, MEDIUM WEIGHT, GRAY COTTON, LOOP IN	S, L	GRAY	12 PR	144 PR
IGTK243	MACHINE KNIT, STANDARD GRADE, MEDIUM WEIGHT, GRAY COTTON, LOOP OUT, NATURAL KNIT WRIST	L	GRAY	12 PR	120 PR
ITC243	CUT AND SEW, STANDARD GRADE, MEDIUM WEIGHT, 100% COTTON, NATURAL TERRY, LOOP OUT, NATURAL KNIT WRIST	L	NATURAL	12 PR	120 PR
ITC24BT	CUT AND SEW, STANDARD GRADE, MEDIUM WEIGHT, 100% COTTON, NATURAL TERRY, LOOP OUT, BAND TOP CUFF	L	NATURAL	12 PR	120 PR
ITC323	CUT AND SEW, STANDARD GRADE, HEAVY WEIGHT, 100% COTTON, NATURAL TERRY, LOOP OUT, YELLOW STRIPED KNIT WRIST	XL	NATURAL	12 PR	120 PR
TKCF024LI	MACHINE KNIT, PREMIUM GRADE, ORANGE COTTON/ACRYLIC/POLYESTER BLEND, LOOP IN.	L	ORANGE	12 PR	144 PR
UKT32WR	CUT AND SEW, PREMIUM GRADE, HEAVY WEIGHT, 100% COTTON NATURAL TERRY, LOOP OUT, TWO NONWOVEN RAYON LINERS, NATURAL KNIT WRIST	L-XL	NATURAL	12 PR	36 PR
UKTWBMITT	HEAVY WEIGHT, MITT-LOOPOUT KEVLAR® TERRY OUTSIDE-INSIDE WOOL / BURLP	L	YELLOW	12 PR	36 PR
UKTWL24TG	CUT AND SEW, PREMIUM GRADE, MEDIUM WEIGHT, 100% ARAMID OUTER WITH WOOL LINER IN PALM AND CUFF, LOOP OUT	L	NATURAL	12 PR	36 PR
UL26FRTBT	CUT AND SEW, PREMIUM GRADE, HEAVY WEIGHT, GLOVE AND BAND TOP CUFF MADE FROM 100% COTTON FLAME RESISTANT RED TERRY, LOOP OUT AND 100% COTTON NATURAL JERSEY LINER	L	RED	12 PR	72 PR
UL26FRTG	TERRY CLOTH GLOVE, CUT AND SEW, PREMIUM GRADE, HEAVY WEIGHT, GLOVE AND GAUNTLET CUFF MADE FROM 100% COTTON FLAME RESISTANT RED TERRY, LOOP OUT AND 100% COTTON NATURAL JERSEY LINER	L	RED	12 PR	36 PR
UMT26NC	CUT AND SEW, PREMIUM GRADE, HEAVY WEIGHT, 100% COTTON MOCK TWIST TERRY, LOOP OUT, 100% COTTON NATURAL JERSEY LINER, NO CUFF	L	NATURAL	12 PR	72 PR
UMTL263	CUT AND SEW, PREMIUM GRADE, HEAVY WEIGHT, 100% COTTON MOCK TWIST TERRY, LOOP OUT, 100% COTTON NATURAL JERSEY LINER, 100% COTTON NATURAL KNIT WRIST	L	BROWN	12 PR	36 PR
UMTL26TG	CUT AND SEW, PREMIUM GRADE, HEAVY WEIGHT, GLOVE AND CUFF MADE FROM 100% COTTON MOCK TWIST TERRY, LOOP OUT, 100% COTTON NATURAL JERSEY LINER	L	BROWN	12 PR	72 PR
UTL293JBT	PREMIUM GRADE, HEAVY WEIGHT, GLOVE AND BAND TOP CUFF MADE FROM 100% COTTON NATURAL TERRY, LOOP IN AND NONWOVEN RAYON LINER	L	NATURAL	12 PR	36 PR
UTL293BTBL	CUT AND SEW, PREMIUM GRADE, HEAVY WEIGHT, GLOVE AND BAND TOP CUFF MADE FROM 100% COTTON NATURAL TERRY, LOOP OUT AND NONWOVEN RAYON LINER	L-XL	NATURAL	12 PR	36 PR
BPI012HE	TERRY CLOTH BAKER PAD, PREMIUM GRADE, HEAVY WEIGHT, 100% COTTON, TWO-PLY, 10 INCH X 12 INCH, NO HAND HOLE, 5" X 1.5" ELASTIC BAND	L	NATURAL	12	72
HPI0KT24NI	HAND PAD, CUT AND SEW, PREMIUM GRADE, MEDIUM WEIGHT, 100% KEVLAR® REVERSIBLE, LOOP IN, WING THUMB, 10" LONG, 5" WIDE.	L	YELLOW	12	72
IBP012H2	TERRY CLOTH BAKER PAD, STANDARD GRADE, HEAVY WEIGHT, 100% COTTON TWO-PLY, 10" X 12", 5" X 1.5" ELASTIC BAND, NO HAND HOLE	L	NATURAL	12	120

Disposables

Our disposable gloves are available in 5 mil latex, nitrile and vinyl, in either unpowered or lightly powdered. Nitrile is also available in an 8 mil. thickness. Disposable gloves offer excellent dexterity and great barrier protection.

For use in laboratories, production, inspection, cleaning and light duty applications, medical and food.

Item Number	Description	Sizes	Color	Pkg Qty	Case Qty
IDLUP5	NON POWDERED BLUE LATEX, 5 MIL	S-L	CREAM	100	1000
IDNUP5EBK	NON POWDERED NITRILE EXAMINATION GRADE, 5 MIL	L-XL	BLACK	100	2000
IDNUP5EBL	NON POWDERED NITRILE EXAMINATION GRADE, 5 MIL	L-XL	BLUE	100	1000
IDNUP5E	NON POWDERED NITRILE EXAMINATION GRADE, 5 MIL	M	BLUE	100	1000
IDNUP6	NON POWDERED NITRILE, 6 MIL	M-L	BLACK	100	1000
IDLF189	YELLOW 18 MIL LATEX, FLOCK LINED	L	YELLOW	12 PR	12 PR



IGTK243



ITC243



ITC24BT



UL26FRTBT



IBP012H2



IDNUP6

Sleeves

Southern Glove sleeves are available in lengths from 10" to 24" and in widths of 3" and 4". Protective sleeves are available in single ply, double ply and Kevlar®/cotton platted styles. Ideal for glass handling, metal stamping, sheet metal, automotive, electrical and light heat applications, industrial maintenance, construction, manufacturing and carpentry.

Cane Mesh Sleeves provide cool comfortable protection from cuts & lacerations, applications include glass handling, sheet and scrap metal or other sharp objects.

Kevlar Sleeves - Constructed at our factory from 100% Kevlar, Southern Glove sleeves are available in lengths from 10" to 24" and in single and double ply. These sleeves come in width options of 3" and 4" to fit everyone in your plant.

- Double Ply Heavy: ASTM F1790 Cut Level 4 - Double Ply Regular: ASTM F1790 Cut Level 4
- Sleeves made of Kevlar fibers are inherently flame-resistant so they resist burning, combustion, or melting

General Maintenance, Material Handling, Assembly, Shipping, and Receiving, Agricultural, Assembly.

Knit Cotton & Woven Denim Sleeves

Item Number	Description	Sizes	Color	Pkg Qty	Case Qty
C18D8	CUT AND SEW 100% COTTON WOVEN DENIM SLEEVE, ELASTIC ON BOTH ENDS, 18" LONG	18"	BLUE	12 PR	144 PR
CTS11	100% COTTON SLEEVE, KNIT, SINGLE-PLY, 11" LONG, 2" WIDE, NO OVERSTITCH.	11" X 2"	NATURAL	12 PR	1440
CTS18	100% COTTON SLEEVE, KNIT, SINGLE-PLY, 18" LONG, 2" WIDE, NO OVERSTITCH	18" X 2"	NATURAL	12 PR	1200
CTS22	100% COTTON SLEEVE, KNIT, SINGLE-PLY, 22" LONG, 2" WIDE, NO OVERSTITCH	22" X 2"	NATURAL	12 PR	500
SCDP0018	100% COTTON SLEEVE, DOUBLE-PLY, 18", 3" WIDTH, RED ELASTIC ONE END	18" X 3"	NATURAL	12 PR	144 PR
SCDPT4018	100% COTTON SLEEVE, DOUBLE-PLY, 18", 4" WIDE, THUMB HOLE ON SERGED EDGE, NAVY OVERSTITCHING	18" X 4"	NATURAL	12 PR	144 PR
SCSP0018	100% COTTON SLEEVE, SINGLE-PLY, 18", 3" WIDE, OVEREDGED BOTH ENDS IN RED	18" X 3"	NATURAL	12 PR	1000
SCSP0018C	100% COTTON SLEEVE, SINGLE-PLY, 18", 3" WIDE, NO OVEREDGE	18" X 3"	NATURAL	12 PR	1000
SCSP0020C	100% COTTON SLEEVE, SINGLE-PLY, 20", 3" WIDE, NO OVEREDGE	20" X 3"	NATURAL	12 PR	875
SKJ299003	COTTON DUCK SLEEVE, OVEREDGED ELASTIC ON BOTH ENDS	24" X 8"	YELLOW	12 PR	104
SKJB99004NT	COTTON DUCK SLEEVE, CUT AND SEW 100% COTTON, NATURAL ELASTIC ON BOTH ENDS, 18" LONG, 8" WIDE	18"	NATURAL	12 PR	96
TB3350S	15 YARD NATURAL TUBING	3"	NATURAL	1	1



CTS11



SCDP0018



SCSP0018



SKJ299003



SKDPM0014



SKDPM0018



SKDPM0018

Aramid Knit Sleeves

Item Number	Description	Sizes	Color	Pkg Qty	Case Qty
KVTUBE	3" WIDE ARAMID TUBING ON A 5 POUND ROLL	ONE SIZE	YELLOW	5	25
SKDPM0018	MEDIUM WEIGHT, DOUBLE-PLY, THUMB HOLE, 3 INCHES WIDE, OVERSTITCHED ONE END RED, 18 INCHES LONG	18" X 3"	YELLOW	12 PR	144 PR
SKCPM0018	ARAMID AND COTTON PLATED, MEDIUM WEIGHT, DOUBLE-PLY, 3 INCHES WIDE, OVERSTITCHED BOTH ENDS RED, 18 INCHES LONG	18" X 3"	YELLOW	12 PR	144 PR
SKCPMT0018	CUT RESISTANT ARAMID AND COTTON, MEDIUM WEIGHT SINGLE-PLY, 3 INCHES WIDE, OVERSTITCHED ON BOTH ENDS, THUMB HOLE, 18 INCHES LONG	18" X 3"	YELLOW	12 PR	144 PR
SKCPMT018N	CUT RESISTANT ARAMID AND COTTON, MEDIUM WEIGHT SINGLE-PLY, 3 INCHES WIDE, OVERSTITCHED ON BOTH ENDS, THUMB HOLE, NON-SLIP, 18 INCHES LONG	18" X 3"	YELLOW	12 PR	144 PR
SKCPMT0022	ARAMID AND COTTON PLATED, MEDIUM WEIGHT, SINGLE-PLY, 3 INCHES WIDE, OVERSTITCHED ON BOTH ENDS, THUMB HOLE, 22 INCHES LONG	22" X 3"	YELLOW	12 PR	72 PR
SKDPM0010	MEDIUM WEIGHT, DOUBLE-PLY, 3 INCHES WIDE, OVERSTITCHED ONE END RED, 10 INCHES LONG	10" X 3"	YELLOW	12 PR	144 PR
SKDPM0014	MEDIUM WEIGHT, DOUBLE-PLY, 3 INCHES WIDE, OVERSTITCHED ONE END RED, 14 INCHES LONG	14" X 3"	YELLOW	12 PR	144 PR
SKDPM0018	MEDIUM WEIGHT, DOUBLE-PLY, 3 INCHES WIDE, OVERSTITCHED ONE END RED, 18 INCHES LONG	18" X 3"	YELLOW	12 PR	144 PR
SKDPM0018N	MEDIUM WEIGHT, DOUBLE-PLY, 3 INCHES WIDE, OVERSTITCHED ONE END RED, NON-SLIP, 18 INCHES LONG	18" X 3"	YELLOW	12 PR	144 PR
SKDPM0022	MEDIUM-WEIGHT, DOUBLE-PLY, 3 INCHES WIDE, ELASTIC OVERSTITCH ON ONE END RED, 22 INCHES LONG	22" X 3"	YELLOW	12 PR	72 PR
SKDPM0022E	MEDIUM-WEIGHT, DOUBLE-PLY, 3 INCHES WIDE, 2 INCH BLUE/GOLD ELASTIC ON ONE END, 22 INCHES LONG	22" X 3"	BLUE/GOLD	12 PR	72 PR

(Continued on next page)

Aramid Knit Sleeves

Item Number	Description	Sizes	Color	Pkg Qty	Case Qty
SKDPM0024	MEDIUM WEIGHT, DOUBLE-PLY, 3 INCHES WIDE, OVERSTITCHED ONE END RED, 24 INCHES LONG	24" X 3"	YELLOW	12 PR	72 PR
SKDPM0114	MEDIUM WEIGHT, DOUBLE-PLY, 3 INCHES WIDE, BAR TACK THUMB, OVERSTITCHED ONE END RED, 14 INCHES LONG	14" X 3"	YELLOW	12 PR	144 PR
SKDPM0118	MEDIUM WEIGHT, DOUBLE-PLY, 3 INCHES WIDE, BAR TACK THUMB, OVERSTITCHED ONE END RED, 18 INCHES LONG	18" X 3"	YELLOW	12 PR	144 PR
SKDPMT010	MEDIUM WEIGHT, DOUBLE-PLY, 3 INCHES WIDE, THUMB HOLE, OVERSTITCHED ONE END RED, 10 INCHES LONG	10" X 3"	YELLOW	12 PR	38 PR
SKDPMT014	MEDIUM WEIGHT, DOUBLE-PLY, 3 INCHES WIDE, THUMB HOLE, OVERSTITCHED ONE END RED, 14 INCHES LONG	14" X 3"	YELLOW	12 PR	144 PR
SKDPMT014N	MEDIUM WEIGHT, DOUBLE-PLY, 3 INCHES WIDE, THUMB HOLE, OVERSTITCHED ONE END RED, NON-SLIP, 14 INCHES LONG	14" X 3"	YELLOW	12 PR	144 PR
SKDPMT018	MEDIUM WEIGHT, DOUBLE-PLY, 3 INCHES WIDE, THUMB HOLE, OVERSTITCHED ONE END RED, 18 INCHES LONG	18" X 3"	YELLOW	12 PR	144 PR
SKDPMT018N	MEDIUM WEIGHT, DOUBLE-PLY, 3 INCHES WIDE, THUMB HOLE, OVERSTITCHED ONE END RED, NON-SLIP, 18 INCHES LONG	18" X 3"	YELLOW	12 PR	144 PR
SKDPMT022	MEDIUM WEIGHT, DOUBLE-PLY, 3 INCHES WIDE, THUMB HOLE, OVERSTITCHED ONE END RED, 22 INCHES LONG	22" X 3"	YELLOW	12 PR	72 PR
SKDPMT022E	MEDIUM-WEIGHT, DOUBLE-PLY, 3 INCHES WIDE, THUMB HOLE, 2 INCH BLUE/GOLD ELASTIC ON ONE END, 22 INCHES LONG	22" X 3"	YELLOW	12 PR	72 PR
SKDPMT0227	MEDIUM WEIGHT, DOUBLE-PLY, 3 INCHES WIDE, THUMB HOLE WITH YELLOW SERGING, OVERSTITCHED ONE END WITH YELLOW THREAD, 22 INCHES LONG	22" X 3"	YELLOW	12 PR	72 PR
SKDPMT0230	MEDIUM WEIGHT, DOUBLE-PLY, 3 INCHES WIDE, THUMB HOLE, OVERSTITCHED ONE END RED, 23 INCHES LONG	23" X 3"	YELLOW	12 PR	72 PR
SKDPMT024	MEDIUM WEIGHT, DOUBLE-PLY, 3 INCHES WIDE, THUMB HOLE, OVERSTITCHED ONE END RED, 24 INCHES LONG	24" X 3"	YELLOW	12 PR	72 PR
SKDPMT118	MEDIUM WEIGHT, DOUBLE-PLY, 3 INCHES WIDE, THUMB HOLE ON FOLDED EDGE, BARTACK IN MIDDLE, OVERSTITCHED ONE END RED, 18 INCHES LONG	18" X 3"	YELLOW	12 PR	144 PR
SKDPMT122	MEDIUM WEIGHT, DOUBLE-PLY, 3 INCHES WIDE, THUMB HOLE ON FOLDED EDGE, BARTACK IN MIDDLE, OVERSTITCHED ONE END RED, 22 INCHES LONG.	22" X 3"	YELLOW	12 PR	49 PR
SKSPH0014	HEAVY WEIGHT, SINGLE-PLY, 3 INCHES WIDE, OVERSTITCHED BOTH ENDS RED, 14 INCHES LONG	14" X 3"	YELLOW	12 PR	144 PR
SKSPM0018	MEDIUM WEIGHT, SINGLE-PLY, 3 INCHES WIDE, OVERSTITCHED BOTH ENDS RED, 18 INCHES LONG	18" X 3"	YELLOW	12 PR	200 PR
SKSPM0022	MEDIUM WEIGHT, SINGLE-PLY, 3 INCHES WIDE, OVERSTITCHED BOTH ENDS RED, 22 INCHES LONG	22" X 3"	YELLOW	12 PR	200 PR
SKSPMT024L	MEDIUM WEIGHT, SINGLE-PLY, THUMB HOLE, 3 INCHES WIDE, OVERSTITCHED BOTH ENDS RED, 24 INCHES LONG	24" X 3"	YELLOW	12 PR	144 PR

Aprons

Ideal for general & industrial maintenance, material handling, assembly, shipping, and receiving, agricultural, glass handling, metal stamping, sheet metal, automotive, electrical, light heat applications, construction, manufacturing and carpentry.

Item Number	Description	Sizes	Color	Pkg Qty	Case Qty
A2424DBT3	24" X 24" DENIM APRON, WHITE SHOE STRING BARTACKED TIES, 3 POCKET	ONE SIZE	BLUE	1	72
A2842D4BTG	28" X 42" DENIM APRON, CHEST & HIP POCKET WITH BAR TACK	ONE SIZE	BLUE	1	36
AD830IG10	28" X 36" DENIM APRON, ONE HIP POCKET, WHITE POLY TIES WITH GROMMETS	ONE SIZE	BLUE	1	36
AD8332B20S	28" X 36", CHEST POCKET, PENCIL POCKET, 2 HIP POCKETS, DENIM TIES	ONE SIZE	BLUE	1	36
K6E41B43FU	30" X 39" COTTON DUCK APRON, SWING CHEST POCKET, 1 HIP POCKET, BARTACKED WHITE TIES	ONE SIZE	NATURAL	1	36
TIE282	28" TEXTURED POLYESTER APRON TIE CUT & TIPPED.	ONE SIZE	NATURAL	1	7200



SKDPM0022



SKDPMT014



SKSPH0014



A2424DBT3



K6E41B43FU



Protective Apparel

Southern Glove Relaxed Fit Coveralls & Lab Coats are ideal for use in laboratories, production, inspection, cleaning and light duty applications, medical and food.

Relaxed Fit Coveralls

Item Number	Description	Sizes	Color	Pkg Qty	Case Qty
CF0003NB	RELAXED FIT COVERALLS, SHORT SLEEVES. 65% POLYESTER, 35% COTTON WOVEN POPLIN, FRONT NECK OPENING SNAPS, 2 FRONT CHEST POCKETS, 2 BACK POCKETS, WITH NO WAIST ELASTIC, BACK PLEATS AND CROTCH PANEL	S, 5XL	BLUE	1	24
CF0003NB_L	TALL, RELAXED FIT COVERALLS, SHORT SLEEVES. 65% POLYESTER, 35% COTTON WOVEN POPLIN, FRONT NECK OPENING SNAPS, 2 FRONT CHEST POCKETS, 2 BACK POCKETS, WITH NO WAIST ELASTIC, BACK PLEATS AND CROTCH PANEL	S, 5XL	BLUE	1	24
CF0003RD	RELAXED FIT COVERALL, SHORT SLEEVES, 5.5 OZ 65% POLYESTER / 35% COTTON WOVEN POPLIN, FRONT NECK OPENING SNAPS, 2 FRONT CHEST POCKETS, 2 BACK POCKETS, WITH NO WAIST ELASTIC, BACK PLEATS AND CROTCH PANEL	S, 5XL	RED	1	24
CF0003RD_L	TALL, RELAXED FIT COVERALL, SHORT SLEEVES, 5.5 OZ 65% POLYESTER / 35% COTTON WOVEN POPLIN, FRONT NECK OPENING SNAPS, 2 FRONT CHEST POCKETS, 2 BACK POCKETS, WITH NO WAIST ELASTIC, BACK PLEATS AND CROTCH PANEL	S, 5XL	RED	1	24
CF0003TN	RELAXED FIT COVERALL, SHORT SLEEVES, 5.5 OZ 65% POLYESTER / 35% COTTON WOVEN POPLIN, FRONT NECK OPENING SNAPS, 2 FRONT CHEST POCKETS, 2 BACK POCKETS, WITH NO WAIST ELASTIC, BACK PLEATS AND CROTCH PANEL	L, 5XL	TAN	1	24



CF0003NB

Lab Coats

Item Number	Description	Sizes	Color	Pkg Qty	Case Qty
LC0002RD	LAB COAT - LONG SLEEVE, 5 REGULAR STAINLESS STEEL SNAPS, NO POCKETS	M-5XL	RED	1	10
LC0003GY	LAB COAT - LONG SLEEVE, WHITE KNIT WRIST CUFF, 5 REGULAR STAINLESS STEEL SNAPS, NO POCKETS	L	GRAY	1	20
LC0003LB	LAB COAT - LONG SLEEVE, WHITE KNIT WRIST CUFF, 5 REGULAR STAINLESS STEEL SNAPS, NO POCKETS	L, 4XL	LIGHT BLUE	1	20
LC0003TN	LAB COAT - LONG SLEEVE, WHITE KNIT WRIST CUFF, 5 REGULAR STAINLESS STEEL SNAPS, NO POCKETS	L-XL	TAN	1	20
LC0004	LAB COAT - LONG SLEEVE, WHITE KNIT WRIST CUFF, 5 REGULAR STAINLESS STEEL SNAPS, 3 POCKETS (2 EXTERIOR HIP AND 1 EXTERIOR CHEST POCKET LEFT SIDE)	S-4XL	NAVY BLUE	1	1
LC0007NB	LAB COAT - LONG SLEEVE W/ KNIT CUFF, 6 REGULAR SS SNAPS, 2 POCKETS (2 INTERIOR HIP POCKETS)	XL-3XL	NAVY BLUE	1	1



LC0002RD



TIG STAR

**FOR ALL YOUR ELECTRIC WELDING ACCESSORIES
AND SMAW (STICK) WELDING NEEDS**

- All torches are rigorously tested using computerized and automated test equipment at the design stage and throughout the entire production process.
- All our components pass rigorous quality control checks prior to assembly.
- Our extensive range of Front End Consumables are manufactured to the highest specification.
- All torches are designed to be tough, damage resistant, and comply with EN60974-7.

Features & Benefits 131

Air Cooled TIG Welding Torches

TIG Star™ 9 & Consumables 132-133

TIG Star™ 17 & Consumables 134-135

TIG Star™ 26 & Consumables 136-137

Water Cooled TIG Welding Torches

TIG Star™ 18 & Consumables 138-139

TIG Star™ 20 & Consumables 140-141

Additional TIG Star™ Accessories

TIG Star™ Torch Holder & Bulb Switch 142

Adapters, Caps, Collets, 142

Collet Bodies, Handles, Hoses,

Insulators, Nozzles, Torch Body

& More

Tungsten Electrodes 143-147

TIG Star™ - Torch Features & Benefits

Weldcraft® Compatible



Trigger Switches

- A range of switch styles and options are available that allow for remote arc control.

Handles and Boots

- Redesigned for improved grip.
- An additional high grip snap on boot enables rapid servicing and a reduction in downtime.

Torch Heads

- Lightweight and durable
- Manufactured with high-temperature resistant silicone rubber insulation.
- All copper components ensure cooler running temperatures and maximum current capacity.

Cable System

- Air and liquid cooled cable assemblies use high-temperature resistant rubber jackets which combine outstanding flexibility and resistance to high heat and abrasion.

Front End Consumables

- Extensive range
- Front End Consumables are manufactured to the highest specification.

TIG Star™ 9

Air Cooled TIG Welding Torch

Rating: 125A DC, 100A AC @ 60% Duty Cycle
EN60974-7 0.0209 TO 3/329/0.5mm-2.4mm Electrodes

Weldcraft® compatible



Alternative Torch Bodies

Rating: 125A DC, 100A AC .020" to 3/32" (0.5mm-2.4mm) electrode.

TS9



TS9F



TS9V



TS9FV



TIG Star™ 9 Air Cooled TIG Welding Torch Kits	
Item Number	Model Description
TS9F252	25' TIG WELDING TORCH WITH FLEXI HEAD 2 PIECE POWER CABLE
TS9FV(12R/25R)	12' OR 25' TIG WELDING TORCH WITH FLEXI HEAD VALVE WITH RUBBER CABLE
TS9FV252	25' TIG WELDING TORCH WITH FLEXI HEAD VALVE, 2 PIECE POWER CABLE
TS9V25R	25' TIG WELDING TORCH WITH VALVE WITH RUBBER CABLE
TS9V(122/252)	12' OR 25' TIG WELDING TORCH WITH VALVE, 2 PIECE POWER CABLE

PACKAGE INCLUDES:

- AIR COOLED 125 AMP TIG TORCH
- COLLET & COLLET BODY
- NOZZLE
- SHORT BACK CAP
- AVAILABLE IN 12' OR 25' SINGLE OR DOUBLE CABLE

A Ceramic Cups		
	Item Number	Description
1	TS13N08*	#3-4 Ceramic Cup 1/4" (6mm) Bore
	TS13N09*	#5 Ceramic Cup 5/16" (8mm) Bore
	TS13N10*	#6 Ceramic Cup 3/8" (10mm) Bore
	TS13N11*	#7 Ceramic Cup 7/16" (11mm) Bore
	TS13N12*	#8 Ceramic Cup 1/2" (13mm) Bore
	TS13N13*	#10 Ceramic Cup 5/8" (16mm) Bore
2	TS796F72 ^Y	#5 Long Ceramic Cup 5/16" (8mm) Bore
	TS796F73 ^Y	#6 Long Ceramic Cup 3/8" (10mm) Bore
3	TS796F77 ^Y	#6 Extra Long Ceramic Cup 3/8" (10mm) Bore

B Gas Lens Cups		
	Item Number	Description
1	TS53N58 ^Y	#4 Gas Lens Cup 1/4" (6mm) Bore
	TS53N59 ^Y	#5 Gas Lens Cup 5/16" (8mm) Bore
	TS53N60 ^Y	#6 Gas Lens Cup 3/8" (10mm) Bore
	TS53N61 ^Y	#7 Gas Lens Cup 7/16" (11mm) Bore
	TS53N61S ^Y	#1S Gas Lens Cup 1/2" (13mm) Bore
2	TS57N75*	#6 Large Diameter Gas Lens Cup 3/8" (10mm) Bore
	TS57N74*	#8 Large Diameter Gas Lens Cup 1/2" (13mm) Bore
	TS53N88*	#10 Large Diameter Gas Lens Cup 5/8" (16mm) Bore
	TS53N87*	#12 Large Diameter Gas Lens Cup 3/4" (19mm) Bore

C Collet Bodies		
	Item Number	Description
1	TS13N25 ^Y	Collet Body .020" (0.5mm) Bore
	TS13N26 ^Y	Collet Body .040" (1.0mm) Bore
	TS13N27 ^Y	Collet Body 1/16" (1.6mm) Bore
	TS13N27M ^Y	Collet Body 5/64" (2.0mm) Bore
	TS13N28 ^Y	Collet Body 3/32" (2.4mm) Bore

D Gas Lens Bodies		
	Item Number	Description
1	TS45V42 ^Y	Gas Lens Body 0.40" (1.0mm) Bore
	TS45V43 ^Y	Gas Lens Body 1/16" (1.6mm) Bore
	TS45V44 ^Y	Gas Lens Body 3/32" (2.4mm) Bore
2	TS45V116S ^Y	Large Diameter Gas Lens Body 1/16" (1.6mm) Bore
	TS45V64S ^Y	Large Diameter Gas Lens Body 3/32" (2.4mm) Bore

E Collets		
	Item Number	Description
1	TS13N20 ^Y	Collet .020" (0.5mm) Bore
	TS13N21 ^Y	Collet .040" (1.0mm) Bore
	TS13N22 ^Y	Collet 1/16" (1.6mm) Bore
	TS13N23 ^Y	Collet 3/32" (2.4mm) Bore
2	TS13N22L ^Y	Large Diameter Gas Lens Collet 1/16" (1.6mm) Bore
	TS13N23L ^Y	Large Diameter Gas Lens Collet 3/32" (2.4mm) Bore

F Gaskets		
	Item Number	Description
1	TS598882 ^Y	Cup Gasket
2	TS54N6320 ^Y	Insulator Large Diameter Gas Lens

G Torch Bodies		
	Item Number	Description
1	TS9	Torch Body including Cup Gasket
2	TS9F	Torch Body Flexi Head
	TS9FV	Torch Body Flexi Head with Valve
3	TS9V	Torch Body with Valve
	TSVS2*	Valve Stem

H Caps		
	Item Number	Description
1	TS41V24	Back Cap Long
2	TS41V35	Back Cap Medium
3	TS41V33	Back Cap Short

I Handle		
	Item Number	Description
	TS105Z55	Handle
	TSH100*	Textured Slip On Handle
	TSH100R*	Ribbed Slip On Handle

J Switch		
	Item Number	Description
	TSSW1*	Bulb Switch

K Power Cables		
	Item Number	Description
	TS57Y01R	Power Cable x 12.5' (3.8m) Rubber
	TS57Y03R	Power Cable x 25' (7.6m) Rubber
	TS57Y012	Power Cable x 12.5' (7.6m) 2 Piece
	TS57Y032	Power Cable x 25' (7.6m) 2 Piece

*Compatible with TIG Star™ No. 17, 18, 20 & 26 TIG Guns

^YCompatible with TIG Star™ No. 20

TIG Star™ 17 Air Cooled TIG Welding Torch

Rating: 150A DC, 115A AC @ 60% Duty Cycle
EN60974-7 0.0209 TO 1/89/0.5mm-3.2mm Electrodes

Weldcraft® compatible

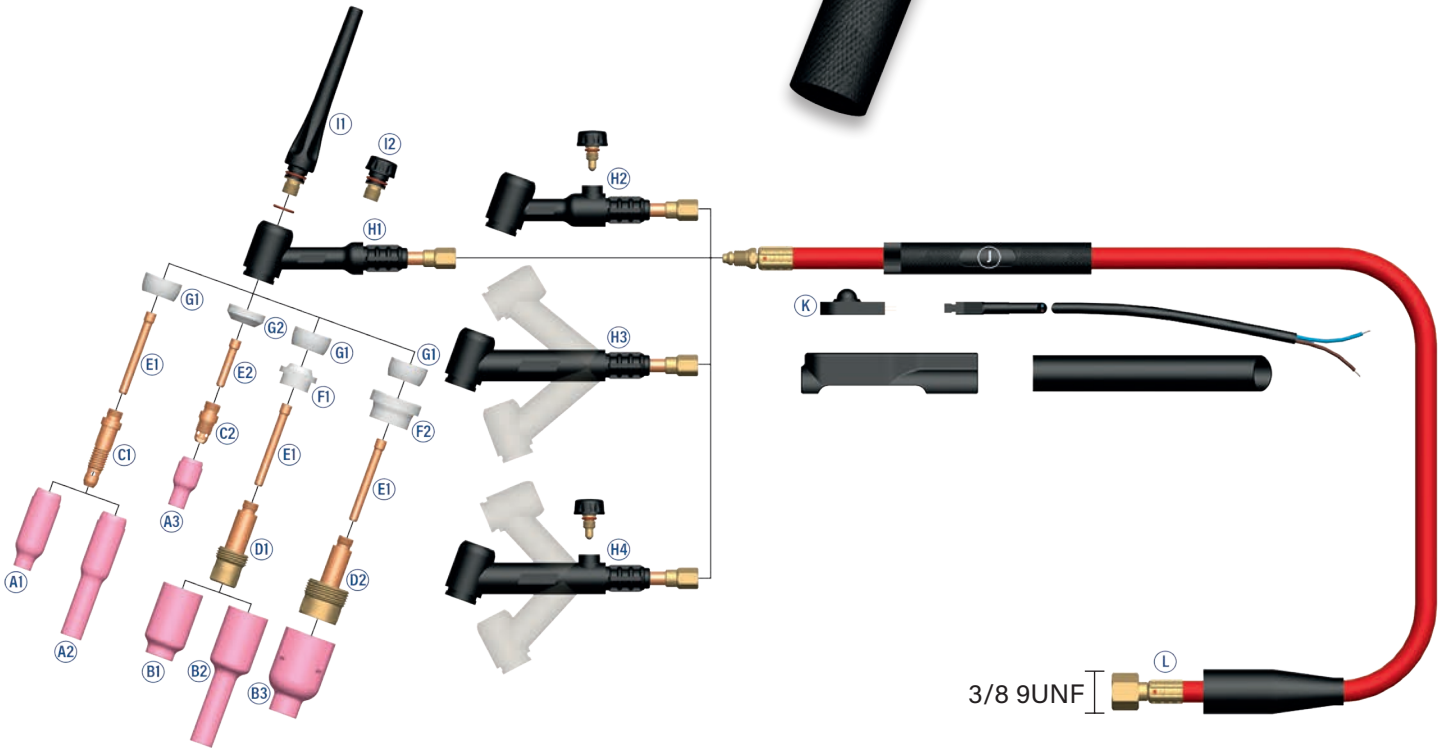

Alternative Torch Bodies

Rating: 150A DC, 115A AC .020" TO 3/32" (0.5mm-2.4mm) electrode.

TS17



TS17F



TS17V



TS17FV



(Continued on next page)

TIG Star™ 17 Air Cooled TIG Welding Torch Kits	
Item Number	Model Description
TS1725	25' TIG WELDING TORCH WITH VINYL POWER CABLE
TS17(12R/25R)	12' OR 25' TIG WELDING TORCH WITH RUBBER CABLE
TS17252	25' TIG WELDING TORCH WITH 2 PIECE POWER CABLE
TS17F(12R/25R)	12' OR 25' TIG WELDING TORCH WITH FLEXI HEAD WITH RUBBER CABLE
TS17FV(12R/25R)	12' OR 25' TIG WELDING TORCH WITH FLEXI HEAD VALVE WITH RUBBER CABLE
TS17FV252	25' TIG WELDING TORCH WITH FLEXI HEAD VALVE, 2 PIECE POWER CABLE
TS17V(12R/25R)	12' OR 25' TIG WELDING TORCH WITH VALVE WITH RUBBER CABLE
TS17V(122/252)	12' OR 25' TIG WELDING TORCH WITH VALVE, 2 PIECE POWER CABLE

- PACKAGE INCLUDES:**
- AIR COOLED 125 AMP TIG TORCH
 - COLLET & COLLET BODY
 - NOZZLE
 - SHORT BACK CAP
 - AVAILABLE IN 12' OR 25' SINGLE OR DOUBLE CABLE

A Ceramic Cups		
	Item Number	Description
1	TS10N44 ^A	#12 Ceramic Cup 3/4" (19mm) Bore
2	TS10N47L ^A	#7 Long Ceramic Cup 7/16" (11mm) Bore
3	TS13N13	#10 Ceramic Cup 5/8" (16mm) Bore

B Gas Lens Cups		
	Item Number	Description
1	TS54N18 ^A	#4 Gas Lens Cup 1/4" (6mm) Bore
	TS54N17 ^A	#5 Gas Lens Cup 5/16" (8mm) Bore
	TS54N16 ^A	#6 Gas Lens Cup 3/8" (10mm) Bore
	TS54N15 ^A	#7 Gas Lens Cup 7/16" (11mm) Bore
	TS54N14 ^A	#8 Gas Lens Cup 1/2" (13mm) Bore
2	TS54N19 ^A	#11 Gas Lens Cup 11/16" (17mm) Bore
	TS54N17L ^A	#5L Long Gas Lens Cup 5/16" (8mm) Bore
	TS54N16L ^A	#6L Long Gas Lens Cup 3/8" (10mm) Bore
3	TS54N15L ^A	#7L Long Gas Lens Cup 7/16" (11mm) Bore
	TS53N87 ^A	#12 Large Diameter Gas Lens Cup 3/4" (19mm) Bore

C Collet Bodies		
	Item Number	Description
1	TS406488 ^A	Collet Body 5/32" (4.0mm) Bore
2	TS17CB20 ^A	Stubby Collet Body 0.20"-1/8" (0.5-3.2mm) Bore

D Gas Lens Bodies		
	Item Number	Description
1	TS45V27 ^A	Gas Lens Body 1/8" (3.2mm) Bore
2	TS995795 ^A	Large Diameter Gas Lens Body 1/8" (3.2mm) Bore

E Collets		
	Item Number	Description
1	TS10N21 ^A	Collet .020" (0.5mm) Bore
	TS10N22 ^A	Collet .040" (1.0mm) Bore
	TS10N23 ^A	Collet 1/16" (1.6mm) Bore
	TS10N24 ^A	Collet 3/32" (2.4mm) Bore
	TS10N25 ^A	Collet 1/8" (3.2mm) Bore
	TS54N20 ^A	Collet 5/32" (4.0mm) Bore
2	TS10N22S ^A	Stubby Collet .040" (1.0mm) Bore
	TS10N23S ^A	Stubby Collet 1/16" (1.6mm) Bore
	TS10N24S ^A	Stubby Collet 3/32" (2.4mm) Bore
	TS10N25S ^A	Stubby Collet 1/8" (3.2mm) Bore

F Insulators		
	Item Number	Description
1	TS54N01 ^A	Cup Gasket
2	TS54N63 ^A	Cup Gasket for Stubby Collet Body

G Gaskets		
	Item Number	Description
1	TS18CG ^A	Cup Gasket
2	TS18CG20 ^A	Cup Gasket for Stubby Collet Body

H Torch Bodies		
	Item Number	Description
1	TS17	Torch Body including Cup Gasket
2	TS17V	Torch Body with Valve
3	TS17F	Torch Body Flexi Head
4	TS17FV	Torch Body Flexi Head with Valve

I Caps		
	Item Number	Description
1	TS57Y02 ^A	Back Cap Long
2	TS57Y04 ^A	Back Cap Short

J Handle		
	Item Number	Description
	TS105Z55	Handle

K Switch		
	Item Number	Description
	TSSW1	Bulb Switch

L Power Cables		
	Item Number	Description
	TS57Y01R	Power Cable x 12.5' (3.8m) Rubber
	TS57Y03R	Power Cable x 25' (7.6m) Rubber
	TS57Y032	Power Cable x 25' (7.6m) 2 Piece

^ACompatible with TIG Star™ No. 18 & 26 TIG Guns

TIG Star™ 26

Air Cooled TIG Welding Torch

Rating: 200A DC, 150A AC @ 60% Duty Cycle
EN60974-7 0.0209 TO 5/329/0.5mm-4.0mm Electrodes

Weldcraft® compatible



Alternative Torch Bodies

Rating: 200A DC, 150A AC .020" to 1/8" (0.5mm-3.2mm) electrode.

TS26



TS26F



TS26V



TS26FV



(Continued on next page)

TIG Star™ 26 Air Cooled TIG Welding Torch Kits	
Item Number	Model Description
TS26(12R/25R)	12' OR 25' TIG WELDING TORCH WITH RUBBER CABLE
TS26252	25' TIG WELDING TORCH WITH 2 PIECE POWER CABLE
TS26F25R	25' TIG WELDING TORCH WITH FLEXI HEAD WITH RUBBER CABLE
TS26FV(12R/25R)	12' OR 25' TIG WELDING TORCH WITH FLEXI HEAD VALVE WITH RUBBER CABLE
TS26FV(122/252)	12' OR 25' TIG WELDING TORCH WITH FLEXI HEAD VALVE, 2 PIECE POWER CABLE
TS26V(12R/25R)	12' OR 25' TIG WELDING TORCH WITH VALVE WITH RUBBER CABLE
TS26V252	25' TIG WELDING TORCH WITH VALVE, 2 PIECE POWER CABLE

- PACKAGE INCLUDES:**
- AIR COOLED 125 AMP TIG TORCH
 - COLLET & COLLET BODY
 - NOZZLE
 - SHORT BACK CAP
 - AVAILABLE IN 12' OR 25' SINGLE OR DOUBLE CABLE

A Ceramic Cups		
	Item Number	Description
1	TS10N50 ^A	#4 Ceramic Cup 1/4" (6mm) Bore
	TS10N49 ^A	#5 Ceramic Cup 5/16" (8mm) Bore
	TS10N48 ^A	#6 Ceramic Cup 3/8" (10mm) Bore
	TS10N47 ^A	#7 Ceramic Cup 7/16" (11mm) Bore
	TS10N46 ^A	#8 Ceramic Cup 1/2" (13mm) Bore
	TS10N45 ^A	#10 Ceramic Cup 5/8" (16mm) Bore
	TS10N44 ^A	#12 Ceramic Cup 3/4" (19mm) Bore
2	TS10N49L ^A	#5 Long Ceramic Cup 5/16" (8mm) Bore
	TS10N48L ^A	#6 Long Ceramic Cup 3/8" (10mm) Bore
	TS10N47L ^A	#7 Long Ceramic Cup 7/16" (11mm) Bore
3	TS13N13*	#10 Ceramic Cup 5/8" (16mm) Bore

B Gas Lens Cups		
	Item Number	Description
1	TS54N19	#11 Gas Lens Cup 11/16" (17mm) Bore
2	TS54N15L	#7L Long Gas Lens Cup 7/16" (11mm) Bore
3	TS53N87	#12 Large Diameter Gas Lens Cup 3/4" (19mm) Bore

C Collet Bodies		
	Item Number	Description
1	TS406488	Collet Body 5/32" (4.0mm) Bore
2	TS17CB20	Stubby Collet Body 0.20"-1/8" (0.5-3.2mm) Bore

D Gas Lens Bodies		
	Item Number	Description
1	TS45V24 ^A	Gas Lens Body 0.40" (1.0mm) Bore
	TS45V25 ^A	Gas Lens Body 1/16" (1.6mm) Bore
	TS45V26 ^A	Gas Lens Body 3/32" (2.4mm) Bore
	TS45V27 ^A	Gas Lens Body 1/8" (3.2mm) Bore
2	TS45V116 ^A	Large Diameter Gas Lens Body 1/16" (1.6mm) Bore
	TS45V64 ^A	Large Diameter Gas Lens Body 3/32" (2.4mm) Bore
	TS995795 ^A	Large Diameter Gas Lens Body 1/8" (3.2mm) Bore

E Collets		
	Item Number	Description
1	TS54N20	Collet 5/32" (4.0mm) Bore
2	TS10N25S	Stubby Collet 1/8" (3.2mm) Bore

F Insulators		
	Item Number	Description
1	TS54N01	Cup Gasket
2	TS54N63	Cup Gasket for Stubby Collet Body

G Gaskets		
	Item Number	Description
1	TS18CG	Cup Gasket
2	TS18CG20	Cup Gasket for Stubby Collet Body

H Torch Bodies		
	Item Number	Description
1	TS26	Torch Body including Cup Gasket
2	TS26V	Torch Body with Valve
3	TS26F	Torch Body Flexi Head
4	TS26FV	Torch Body Flexi Head with Valve

I Caps		
	Item Number	Description
1	TS57Y02	Back Cap Long
2	TS57Y04	Back Cap Short

J Handle		
	Item Number	Description
	TS10N15	Handle

K Switch		
	Item Number	Description
	TSSW1	Bulb Switch

L Power Cables		
	Item Number	Description
	TS46V28R	Power Cable x 12.5' (3.8m) Rubber
	TS46V30R	Power Cable x 25' (7.6m) Rubber
	TS46V302	Power Cable x 25' (7.6m) 2 Piece

^ACompatible with TIG Star™ No. 17 & 18 TIG Guns

TIG Star™ 18

Water Cooled TIG Welding Torch

Rating: 350A DC, 260A AC @ 100% Duty Cycle
EN60974-7 0.0209 TO 5/329/0.5mm-4.0mm Electrodes

Weldcraft® compatible

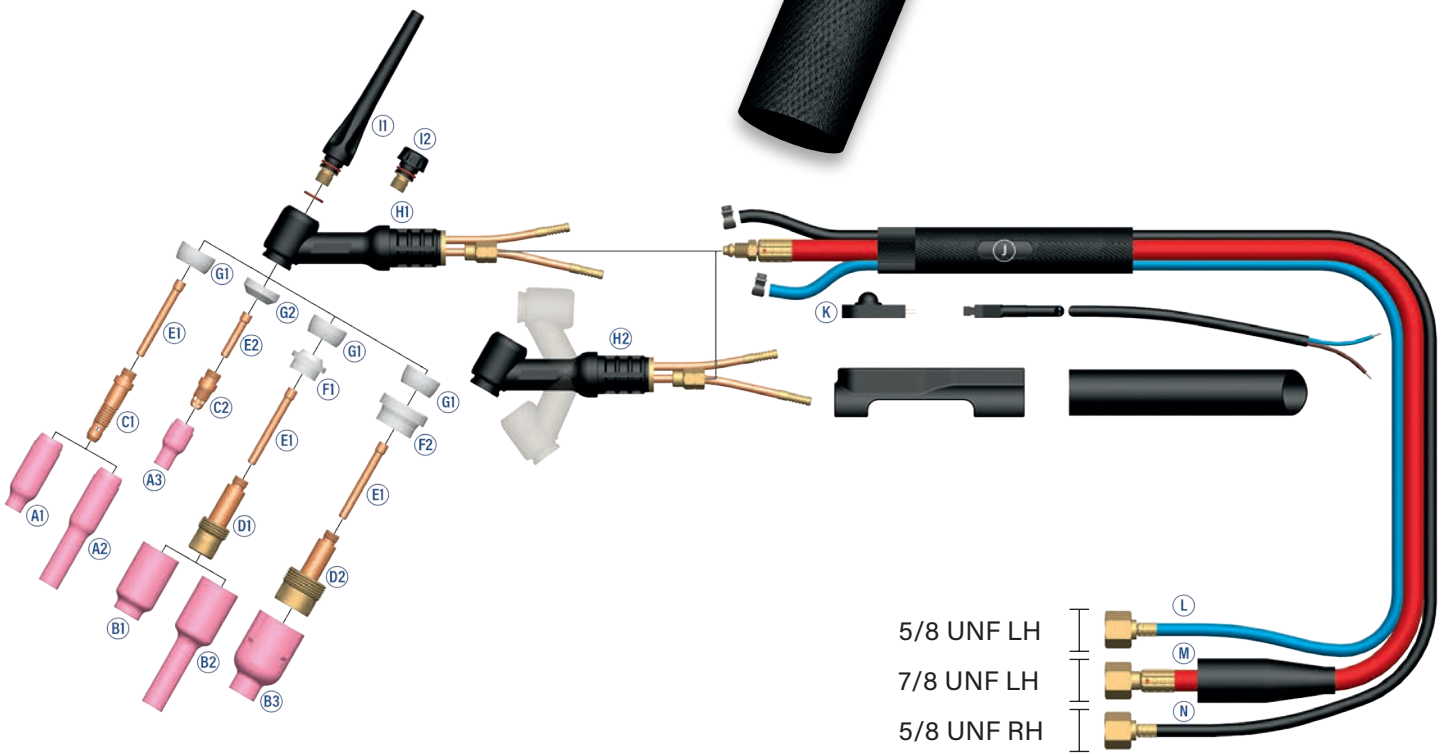
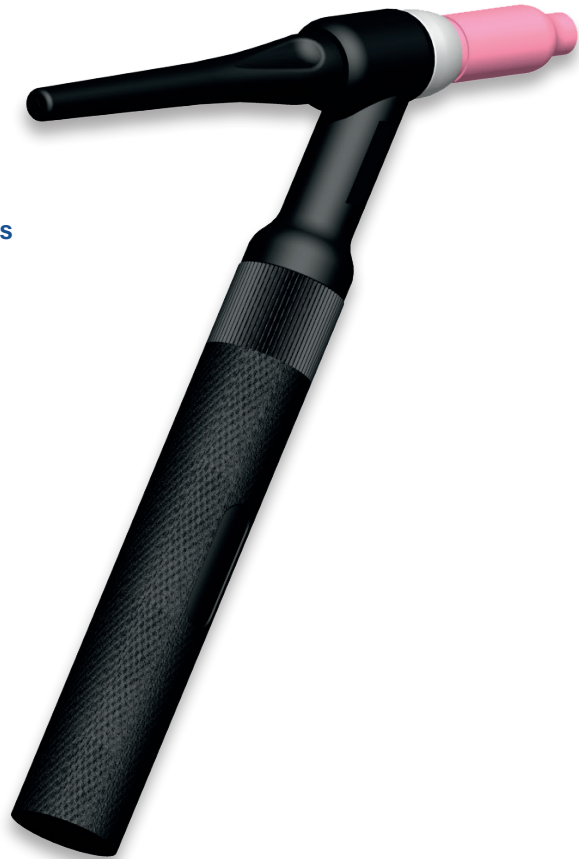

Alternative Torch Bodies

Rating: 350A DC, 260A AC .020" TO 5/32" (0.5mm-4.0mm) electrode.

TS18

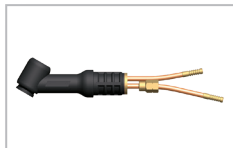

TS18F

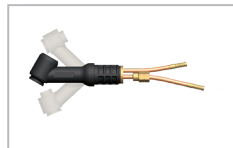

TIG Star™ 18 Water Cooled TIG Welding Torch Kits	
Item Number	Model Description
TS18(12/25)	12' OR 25' TIG WELDING TORCH WITH VINYL POWER CABLE
TS1825R	25' TIG WELDING TORCH WITH RUBBER CABLE
TS18F(12R/25R)	12' OR 25' TIG WELDING TORCH WITH FLEXI HEAD WITH RUBBER CABLE
TS18V25R	25' TIG WELDING TORCH WITH VALVE WITH RUBBER CABLE

- PACKAGE INCLUDES:**
- AIR COOLED 125 AMP TIG TORCH
 - COLLET & COLLET BODY
 - NOZZLE
 - SHORT BACK CAP
 - AVAILABLE IN 12' OR 25' SINGLE OR DOUBLE CABLE

A Ceramic Cups		
	Item Number	Description
1	TS10N44	#12 Ceramic Cup 3/4" (19mm) Bore
2	TS10N47L	#7 Long Ceramic Cup 7/16" (11mm) Bore
3	TS13N13	#10 Ceramic Cup 5/8" (16mm) Bore

B Gas Lens Cups		
	Item Number	Description
1	TS54N19	#11 Gas Lens Cup 11/16" (17mm) Bore
2	TS54N15L	#7L Long Gas Lens Cup 7/16" (11mm) Bore
3	TS53N87	#12 Large Diameter Gas Lens Cup 3/4" (19mm) Bore

C Collet Bodies		
	Item Number	Description
1	TS10N29 ^A	Collet Body .020" (0.5mm) Bore
	TS10N30 ^A	Collet Body .040" (1.0mm) Bore
	TS10N31 ^A	Collet Body 1/16" (1.6mm) Bore
	TS10N32 ^A	Collet Body 3/32" (2.4mm) Bore
	TS10N28 ^A	Collet Body 1/8" (3.2mm) Bore
	TS406488 ^A	Collet Body 5/32" (4.0mm) Bore
2	TS17CB20 ^A	Stubby Collet Body 0.20"-1/8" (0.5-3.2mm) Bore

D Gas Lens Bodies		
	Item Number	Description
1	TS45V28	Gas Lens Body 5/32" (4.0mm) Bore
2	TS45V63	Large Diameter Gas Lens Body 5/32" (4.0mm) Bore

E Collets		
	Item Number	Description
1	TS54N20	Collet 5/32" (4.0mm) Bore
2	TS10N25S	Stubby Collet 1/8" (3.2mm) Bore

F Insulators		
	Item Number	Description
1	TS54N01	Cup Gasket
2	TS54N63	Cup Gasket for Stubby Collet Body

G Gaskets		
	Item Number	Description
1	TS18CG	Cup Gasket
2	TS18CG20	Cup Gasket for Stubby Collet Body

H Torch Bodies		
	Item Number	Description
1	TS18	Torch Body including Cup Gasket
2	TS18F	Torch Body Flexi Head

I Caps		
	Item Number	Description
1	TS57Y02	Back Cap Long
2	TS57Y04	Back Cap Short

J Handle		
	Item Number	Description
	TS10N15	Handle
	TSH200	Textured Slip On Handle

K Switch		
	Item Number	Description
	TSSW1	Bulb Switch

L Water Hose		
	Item Number	Description
	TS45V08	Vinyl Water Hose x 25' (7.6m)

M Power Cables		
	Item Number	Description
	TS41V29	Power Cable x 25ft (7.6m) Vinyl
	TS41V29R	Power Cable x 25ft (7.6m) Rubber

N Gas Hoses		
	Item Number	Description
	TS45V09	Vinyl Gas Hose x 12.5ft (3.8m)
	TS45V10	Vinyl Gas Hose x 25ft (7.6m)

^ACompatible with TIG Star™ No. 17 & 26 TIG Guns

TIG Star™ 20

Water Cooled TIG Welding Torch

250A DC, 190A AC @ 100% Duty Cycle
 EN60974-7 0.020" - to 1/8" / 0.5mm-3.2mm Electrodes

Weldcraft® compatible

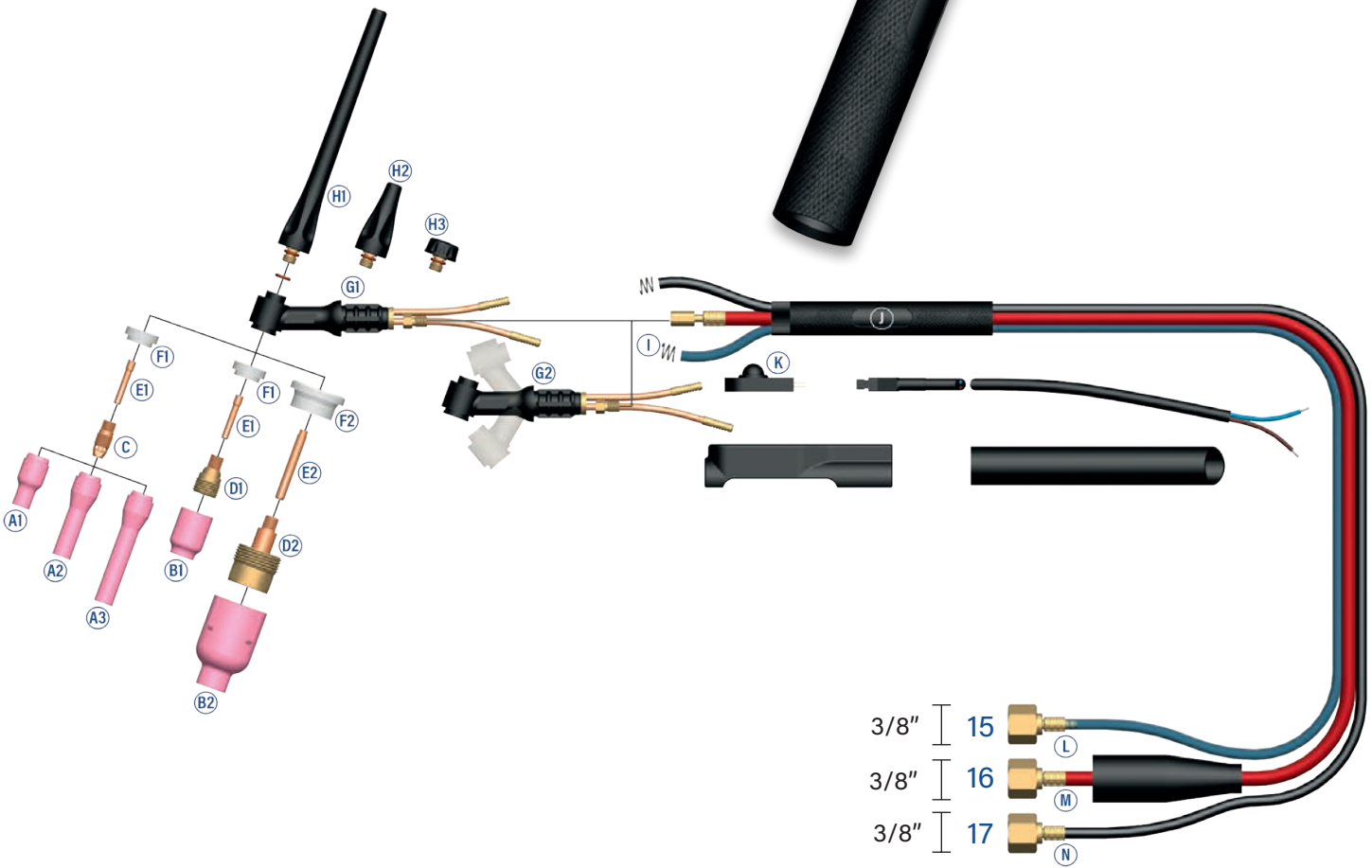
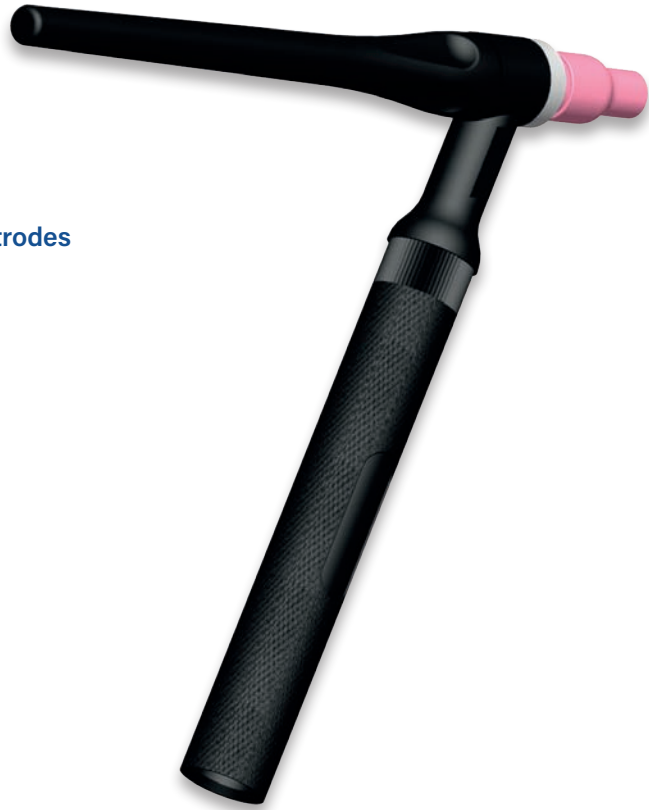

Alternative Torch Bodies

Rating: 250A DC, 190A AC .020" TO 1/8" (0.5mm-3.2mm) electrode.

TS20

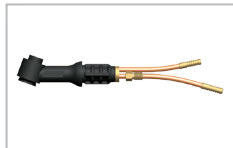

TS20F

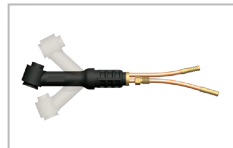

TIG STAR

TIG Star™ 20 Water Cooled TIG Welding Torch Kits	
Item Number	Model Description
TS2025	25' TIG WELDING TORCH WITH VINYL POWER CABLE
TS20F25R	25' TIG WELDING TORCH WITH FLEXI HEAD RUBBER POWER CABLE
TS2025R	25' TIG WELDING TORCH WITH PENCIL HEAD RUBBER POWER CABLE

- PACKAGE INCLUDES:**
- AIR COOLED 125 AMP TIG TORCH
 - COLLET & COLLET BODY
 - NOZZLE
 - SHORT BACK CAP
 - AVAILABLE IN 12' OR 25' SINGLE OR DOUBLE CABLE

A Ceramic Cups		
	Item Number	Description
1	TS13N13	#10 Ceramic Cup 5/8" (16mm) Bore
2	TS796F72 TS796F7	#4 Long Ceramic Cup 5/16" (8mm) Bore #5 Long Ceramic Cup 5/16" (8mm) Bore
3	TS796F77	#6 Extra Long Ceramic Cup 3/8" (10mm) Bore

H Caps		
	Item Number	Description
1	TS41V24	Back Cap Long
2	TS41V35	Back Cap Medium
3	TS41V33	Back Cap Short

B Gas Lens Cups		
	Item Number	Description
1	TS54N19	#1S Gas Lens Cup 1/2" (13mm) Bore
2	TS53N87	#12 Large Diameter Gas Lens Cup 3/4" (19mm) Bore

I Wire Clamp		
	Item Number	Description
	TS53N04	Wire Clamp

C Collet Bodies		
	Item Number	Description
	TS13N29	Collet Body 1/8" (3.2mm) Bore

J Handle		
	Item Number	Description
	TS105Z55	Handle

D Gas Lens Bodies		
	Item Number	Description
1	TS45V45	Gas Lens Body 1/8" (3.2mm) Bore
2	TS45V64S	Large Diameter Gas Lens Body 3/32" (2.4mm) Bore

K Switch		
	Item Number	Description
	TSSW1	Bulb Switch

E Collets		
	Item Number	Description
1	TS13N24	Collet 1/8" (3.2mm) Bore
2	TS13N23L	Large Diameter Gas Lens Collet 3/32" (2.4mm) Bore

L Water Hose		
	Item Number	Description
	TS45V08	Vinyl Water Hose x 25' (7.6m)

F Gaskets		
	Item Number	Description
1	TS598882	Cup Gasket
2	TS54N6320	Insulator Large Diameter Gas Lens

M Power Cables		
	Item Number	Description
	TS45V03	Power Cable x 12.5' (3.8m) Vinyl
	TS45V04	Power Cable x 25' (7.6m) Vinyl

G Torch Bodies		
	Item Number	Description
1	TS20	Torch Body including Cup Gasket
2	TS20F	Torch Body Flexi Head

N Gas Hoses		
	Item Number	Description
	TS45V09	Vinyl Gas Hose x 12.5ft (3.8m)
	TS45V10	Vinyl Gas Hose x 25ft (7.6m)

TIG Star™ Holder

Item Number	Description
TSTIGHOLDER	<ul style="list-style-type: none"> • Magnetic base • Keeps your TIG gun secure when not in use • Works in vertical and horizontal positions • Durable enamel finish with zinc coated base



TIG Star™ Bulb Switch

Item Number	Description
TSSW1	• SW-1 Bulb Switch
TSSW1F	• SW-1 Flat Switch



Additional MIG Parts, Components & Consumables

Adapters

Item Number	Description
TS105Z57	Power Cable Adapter
TS45V11	Power Cable Adapter
TS45V62	Power Cable Adapter
TS53N43	Power Cable Adapter

Caps

Item Number	Description
TS300M	Back Cap Medium
TS41V44	Back Cap Long

Collets

Item Number	Description
TS24C332	Collet 3/32" (2.4mm) Bore
TS49V24	Collet 3/32" (2.4mm) Bore
TS49V25	Collet 1/8" (3.2mm) Bore
TS53N14	Collet 1/16" (1.6mm) Bore
TS57N50	Collet 3/16" (4.7mm) Bore
TS85Z16	Collet 1/8" (3.2mm) Bore

Collet Bodies

Item Number	Description
TS53N19	Collet Body 1/16" (1.6mm) Bore

Handles

Item Number	Description
TS105Z55R	105Z55 Ribbed Handle
TS10N15R	10N15 Ribbed Handle
TS53N06	53N06 Handle
TS53N06R	53N06 Ribbed Handle
TSH200	H-200 Textured Slip On Handle
TSH200R	H-200 Ribbed Textured Slip On Handle

Hoses

Item Number	Description
TS40V74	Water Hose
TS40V75	Gas Hose
TS40V77	Argon Hose
TS40V77L	Gas Hose
TS41V32	Vinyl Water Hose x 25ft (7.6m)
TS41V32R	Rubber Water Hose x 25ft (7.6m)
TS45V08R	Water Hose Braided Rubber
TS45V10R	Gas Hose Braided Rubber

Insulators

Item Number	Description
L10603D00	Insulator
TS187	Back Insulator
TS53N22	Insulator Gasket
TS53N66	Gas Lens Insulator

Nozzles

Item Number	Description
L10603C02	#8 Nozzle
TS14N59	#6 Gas Lens Alumina Cup 3/8" (10mm) Bore
TS53N25	#5 Gas Lens Lava Cup 5/16" (8mm) Bore
TS53N26	#6 Gas Lens Lava Cup 3/8" (10mm) Bore
TS53N87L	#6 Gas Lens Lava Cup 3/8" (10mm) Bore
TS53N64	#12 Gas Lens Cup 2-2/3"
TS53N87XL/XXL	#12XL/XXL Gas Lens Alumina Cup
TS53N88L/XXL	#10L/XXL Gas Lens Alumina Cup
TS53N89	#15 Gas Lens Alumina Cup
TS54N14L	#8 Long Gas Lens Cup
TS54N31	#8 Gas Lens Lava Cup
TS57N74L/XL/XXL	#8L/XL/XXL Long Gas Alumina Cup
TS57N75L/XL/XXL	#6L/XL/XXL Long Gas Alumina Cup
TS995795S	Gas Lens Collet Body LG Stubby 1/8

Torch Body

Item Number	Description
TS18V	Torch Body With Valve

Misc

Item Number	Description
TSAK2	AK-2 Accessory Kit
TSAK4	AK-4 Accessory Kit
TSBS1	BS-1 Single Boot Switch
TSCC310	CC3-10 Cable Cover 10 Ft.
TSCC322	CC3-22 Cable Cover 22 Ft.
TSCC422	CC4-22 Cable Cover 22 Ft.
TSIPPE002	PPE-002 Diamond Wheel
TSIPPE002B	PPE-002 Premium Diamond Wheel
TSITSPPE	TS-PPE Standard Tungsten Grinder
TSITSPPEADJ	TS-PPE Adjustable Tungsten Grinder
TSPPE220	TS-PPE Standard Tungsten Grinder
TSTTC150	TTC-150 TIG Torch Connector
TSTTC200	TTC-200 TIG Torch Connector
TSVS1	VS1 Valve Knob Stem
U4167G02	Orifice 350A

Tungsten Electrodes

1% Thoriated (Yellow) EWTh-1

Principle Oxide: 0.80 - 1.2% Thorium Oxide

Designation for thorium dioxide doped tungsten electrodes containing 0.8% to 1.2% ThO₂. These electrodes provide easy arc starting, arc stability, good current capacity, and resistance to weld pool contamination.



2% Thoriated (Red) EWTh-2/WT20

Principle Oxide: 1.7 - 2.2% Thorium Oxide

Radioactive. Best for use in Direct Current (D/C) applications using transformer based constant current power sources. Best for use on non-corroding steels, titanium alloys, nickel alloys, copper alloys. Good D/C arc starts and stability, medium erosion rate, medium amperage range, medium tendency to spit.

1% Lanthanated (Black) EWLa-1

Principle Oxide: 0.90 - 1.2% Lanthanum Oxide

Non-radioactive. Suitable for use in Direct Current (D/C) or Alternating Current (A/C). These electrodes have excellent arc starting, low-burn-off rate, good arc stability and excellent re-ignition characteristics. Maintain a sharpened point well and can replace both ceriated and thoriated because, unlike thoriated tungsten, these electrodes are suitable for AC welding and, like ceriated electrodes, they allow for lower voltage arcs.



1.5% Lanthanated (Gold) EWLa-1.5/WL15

Principle Oxide: 1.3 - 1.7% Lanthanum Oxide

Non-radioactive. Best for use in Direct Current (D/C) as an alternative to 2% Thoriated using inverter or transformer based constant current power sources. Best for non-corroding steels, titanium alloys, nickel alloys, copper alloys. Best D/C arc starts and stability, low erosion rate, wide amperage range, no spitting.

2% Lanthanated (Blue) EWLa-2/WL20

Principle Oxide: 1.8 - 2.2% Lanthanum Oxide

Non-radioactive. Best general purpose electrode for both Alternating Current (A/C) or Direct Current (D/C) using inverter or transformer based constant current power sources. Good for low-alloyed steels, non-corroding steels, aluminum alloys, magnesium alloys, titanium alloys, nickel alloys, copper alloys. Good arc starts and stability, medium to high amperage range, low erosion rate.



(Continued on next page)

Tungsten Electrodes



2% Ceriated (Gray) EWCe-2/WL20 **Principle Oxide: 1.8 - 2.2% Cerium Oxide**

Non-radioactive. Best for use in Alternating Current (A/C) or Direct Current (D/C) applications using inverter or transformer based constant current power sources. Good for low-alloyed steels, non-corroding steels, aluminum alloys, magnesium alloys, titanium alloys, nickel alloys, copper alloys. Good ignition and re-ignition properties, long service life, excellent arc stability. Low erosion rate, best at low amperage range, no spitting, good D/C arc starts and stability.

Pure (Green) EWP/WP **Principle Oxide: None**

Non-radioactive. Best for use in Alternating Current (A/C) for aluminum alloys and magnesium alloys in low to medium amperage applications using transformer based constant current power sources only. Balls easy, tends to spit at higher amperages. Used for non-critical welds only.



0.3% Zirconiated (Brown) EWZr-1/WZ3 **Principle Oxide: 0.3% Zirconium Oxide**

Non-radioactive. Best for Alternating Current (A/C) for aluminum and magnesium alloys using inverter or transformer based constant current power sources. Retains a balled during welding, and has a high resistance to contamination. Better arc starts, stability, and less splitting than pure.



8% Zirconiated (White) AWS A5.12 WEZr-8 **Principal Oxide: 0.7- 0.9% Zirconium Oxide**

White zirconiated tungsten electrodes handle higher amperage levels and work well with both transformer and inverter power sources, making them an excellent alternative to the green pure tungsten electrodes for magnesium and aluminum alloys.



Super Blend (Purple) EWG **Principle Oxide: 1.5% Lanthanum Oxide, .08% Zirconium Oxide, .08% Yttrium Oxide**

Non-radioactive. Best for use in Alternating Current (A/C) or Direct Current (D/C) application using inverter or transformer based constant current power sources. The innovative Super Blend electrode is an excellent substitute for 2% Thoriated red tungsten and boasts the same high performance properties. It's best used when welding aluminum alloys, magnesium alloys, titanium alloys, nickel alloys, copper alloys, low-alloyed steels, and non-corrosive steels.



(Continued on next page)

Tungsten Electrode Guide

YELLOW 1% Thoriated AWS A5.12 EWTh-1 ISO 6848 WT20		
Size		Item Number
Inches	Millimeters	10 Piece
.040 x 7"	1.0 x 175 mm	TU1T0407
3/32 x 7"	2.4 x 175 mm	TU1T0937

RED 2% Thoriated AWS A5.12 EWTh-2 ISO 6848 WT20		
Size		Item Number
Inches	Millimeters	10 Piece
.020 x 3"	.5 x 76.2 mm	TU2T0203
.020 x 7"	.5 x 175 mm	TU2T0207
.040 x 3"	1.0 x 76.2 mm	TU2T0403
.040 x 7"	1.0 x 175 mm	TU2T0407
1/16 x 12"	1.6 x 304.8 mm	TU2T06212
1/16 x 18"	1.6 x 457.2 mm	TU2T06218
1/16 x 3"	1.6 x 76.2 mm	TU2T0623
1/16 x 7"	1.6 x 175 mm	TU2T0627
3/32 x 12"	2.4 x 304.8 mm	TU2T09312
3/32 x 3"	2.4 x 76.2 mm	TU2T0933
3/32 x 7"	2.4 x 175 mm	TU2T0937
3/32 x 7"	2.4 x 175 mm	TU2T0937C
1/8 x 3"	3.2 x 76.2 mm	TU2T1253
1/8 x 7"	3.2 x 175 mm	TU2T1257
5/32 x 12"	3.96 x 304.8 mm	TU2T15612
5/32 x 7"	3.96 x 175 mm	TU2T1567
3/16 x 18"	4.76 x 457.2 mm	TU2T18718
3/16 x 7"	4.76 x 175 mm	TU2T1877
1/4 x 7"	6.35 x 175 mm	TU2T2507

BLACK 1% Lanthanated AWS A5.12 EWLa-1 ISO 6848 WL10		
Size		Item Number
Inches	Millimeters	10 Piece
1/16 x 7"	1.6 x 175 mm	TU1L0627
3/32 x 7"	2.4 x 175 mm	TU1L0937
1/8 x 7"	3.2 x 175 mm	TU1L1257
5/32 x 7"	3.96 x 175 mm	TU1L1567

(Continued on next page)

Tungsten Electrode Guide

GOLD | 1.5% Lanthanated | AWS A5.12 EWL_a-1.5 | ISO 6848 WL15

Size		Item Number
Inches	Millimeters	10 Piece
.020 x 7"	.5 x 175 mm	TU15L0207
.040 x 7"	1.0 x 175 mm	TU15L0407
1/16 x 7"	1.6 x 175 mm	TU15L0627
3/32 x 7"	2.4 x 175 mm	TU15L0937
1/8 x 7"	3.2 x 175 mm	TU15L1257
5/32 x 7"	3.96 x 175 mm	TU15L1567
.187 x 12"	4.75 x 304.8 mm	TU15L18712

BLUE | 2% Lanthanated | AWS A5.12 EWL_a-2 | ISO 6848 WL20

Size		Item Number
Inches	Millimeters	10 Piece
1/16 x 7"	1.6 x 175 mm	TU2L0627
3/32 x 7"	2.4 x 175 mm	TU2L0937
1/8 x 7"	3.2 x 175 mm	TU2L1257
3/16 x 7"	4.76 x 175 mm	TU2L1877

GRAY | 2% Ceriated | AWS A5.12 EWC_e-2 | ISO 6848 WC20

Size		Item Number
Inches	Millimeters	10 Piece
.040 x 7"	1.0 x 175 mm	TU2C0407
1/16 x 7"	1.6 x 175 mm	TU2C0627
3/32 x 7"	2.4 x 175 mm	TU2C0937
1/8 x 7"	3.2 x 175 mm	TU2C1257
3/16 x 7"	4.76 x 175 mm	TU2C1877

(Continued on next page)

Tungsten Electrode Guide

GREEN Pure AWS A5.12 EWP ISO 6848 WP		
Size		Item Number
Inches	Millimeters	10 Piece
.040 x 7"	1.0 x 175 mm	TUP0407
1/16 x 7"	1.6 x 175 mm	TUP0627
3/32 x 7"	2.4 x 175 mm	TUP0937
1/8 x 7"	3.2 x 175 mm	TUP1257
1/8 x 12"	3.2 x 304.8 mm	TUP12512
5/32 x 7"	3.96 x 175 mm	TUP1567
3/16 x 7"	4.76 x 175 mm	TUP1877

BROWN .3% Zirconiated AWS A5.12 EWZr-1 ISO 6848 WZ3		
Size		Item Number
Inches	Millimeters	10 Piece
.040 x 7"	1.0 x 175 mm	TUZ0407
1/16 x 7"	1.6 x 175 mm	TUZ0627
3/32 x 7"	2.4 x 175 mm	TUZ0937
1/8 x 7"	3.2 x 175 mm	TUZ1257
5/32 x 7"	3.96 x 175 mm	TUZ1567
3/16 x 7"	4.76 x 175 mm	TUZ1877

WHITE .8% Zirconiated AWS A5.12 EWZr-8 ISO 6848 WZ8		
Size		Item Number
Inches	Millimeters	10 Piece
3/32 x 7"	2.4 x 175 mm	TU8Z0937
1/8 x 7"	3.2 x 175 mm	TU8Z1257

Purple Super Blend AWS A5.12M/A5.12:2009		
Size		Item Number
Inches	Millimeters	10 Piece
1/16 x 7"	1.6 x 175 mm	TUE30627
1/8 x 7"	3.2 x 175 mm	TUE31257
1/16 x 7"	1.6 x 175 mm	TUSB0627
3/32 x 7"	2.4 x 175 mm	TUSB0937
1/8 x 7"	3.2 x 175 mm	TUSB1257
1/4 x 7"	6.35 x 175 mm	TUSB2507
5/32 x 7"	3.96 x 175 mm	TUSB1567

TECHNIWELDUSA

QUALITY MANUFACTURER AND PROCESSOR OF WELDING SUPPLIES AND ALLOYS



ARC STAR

**FOR ALL YOUR ELECTRIC WELDING ACCESSORIES
AND SMAW (STICK) WELDING NEEDS**



ARMOUR GUARD

**FOR ALL YOUR FIRE RESISTANT CLOTHING,
HELMETS, AND SAFETY RELATED PRODUCTS**



BLUE STAR

**FOR ALL YOUR OXY-FUEL WELDING,
CUTTING, AND GAS FLOW CONTROL**



CHEM STAR

FOR ALL YOUR CHEMICAL RELATED PRODUCTS



FILLER METALS

**FOR ALL YOUR MILD STEEL, ALUMINUM, STAINLESS,
STEEL, NICKEL, AND ALL OTHER ALLOYS**



GRIP STAR

**FOR ALL YOUR HAND, CLAMPING,
AND PIPING TOOL NEEDS**



MIG STAR

**FOR ALL YOUR MIG GUNS,
PARTS AND ACCESSORIES**



SAND STAR

FOR ALL YOUR WELDING ABRASIVE NEEDS



**DESIGNED TO PROTECT
MANUFACTURED TO LAST**



TIG STAR

**FOR ALL YOUR TIG TORCHES, PARTS,
AND ACCESSORIES**

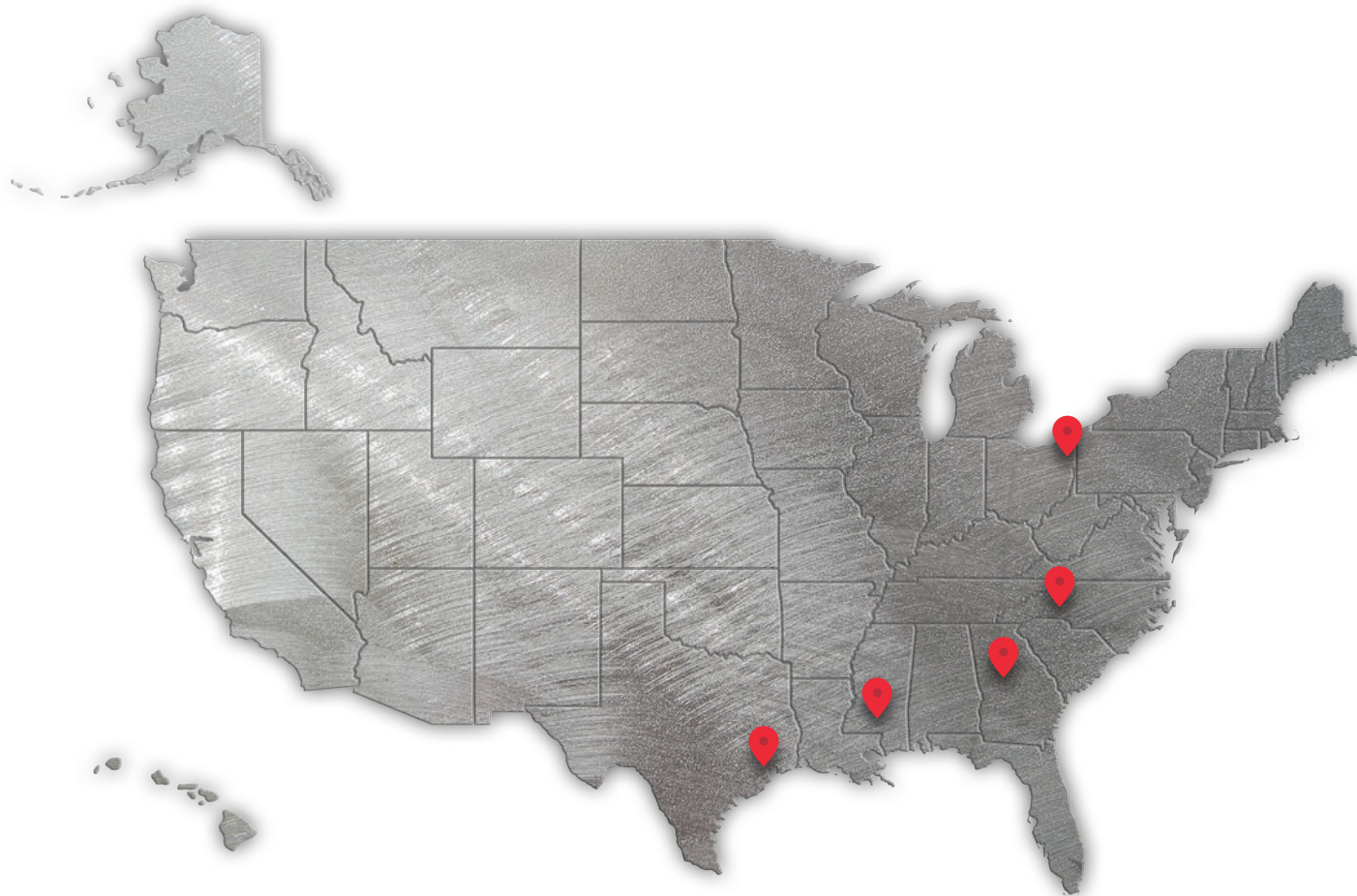

Call any of our locations for additional vendors and product information

 **Corporate Office**
6205 Boat Rock Blvd. SW
Atlanta, Georgia 30336
Toll Free: (800) 445-2152
Fax: (404) 699-7800
Email: sales@twusa.com

 **Houston, Texas**
6015 Murphy Street
Houston, TX 77033
Toll Free: (877) 674-5586
Fax: (713) 996-7180
Email: sales@twusa.com

 **Jackson, Mississippi**
880 South Roach Rd.
Jackson, MS 39201
Toll Free: (800) 647-7144
Fax: (601) 718-1102
Email: sales@twusa.com

 **Exports Office**
6205 Boat Rock Blvd. SW
Atlanta, Georgia 30336
Toll Free: (800) 445-2152
Fax: (404) 856-4894
Email: exportoffice@twusa.com

 **Youngstown, Ohio**
1120 Oak Hill Ave
Youngstown, OH 44502
Toll Free: (877) 489-3847
Fax: (330) 743-9610
Email: sales@twusa.com

 **Newton, North Carolina**
749 AC Little Dr
Newton, NC 28658
Toll Free: (800) 222-1113
Fax: (828) 464-7968
Email: sales@twusa.com



WANT TO RECEIVE OUR EMAILS?



Receive the hottest Techniweld USA deals and news first!
Contact sales@twusa.com to join our email list.

FOLLOW US ON SOCIAL MEDIA



TECHNIWELDUSA

6205 Boat Rock Blvd. SW
Atlanta, Georgia 30336-2727

Toll Free: (800) 445-2152

Fax: (404) 699-7800

sales@twusa.com

twusa.com

Revised 11-29-2022

CATALOG



8 43088 16121 4